

# Principles of Genetics



AGRIMOON.COM

All About Agriculture...

# PRINCIPLE OF GENETICS

This eCourse Developed By  
**TNAU (ICAR)**



**AGRIMOON.COM**

*All About Agriculture...*

# Index

<b>SN</b>	<b>Lecture</b>	<b>Page No</b>
1.	History of Genetic	1-9
2.	Mendel's laws of inheritance and exceptions to the laws.	10-28
3.	Types of gene action	29-37
4.	Multiple alleles	38-43
5.	Multiple factor hypothesis.	44-47
6.	Quantitative traits - Qualitative traits and differences between them	48-54
7.	Cytoplasmic inheritance	55-60
8.	Methods of inducing mutations and C / B technique.	61-66
9.	Mutation - it's characteristic features –	67-75
10.	Regulation Gene expression	76-82
11.	Lac operon and Fine structure of Gene.	83-98
12.	Ultra structure of cell and cell organelles and their functions.	99-118
13.	Study of chromosome structure, morphology, number and types - Karyotype and Ideogram.	119-135
14.	Mitosis and meiosis - their significance and differences between them.	136-151
15.	DNA and its structure, function, types, modes of replication and repair.	152-166
16.	RNA and its structure function and types.	167-178
17.	Transcription – Translation - Genetic code and outline of protein synthesis.	179-202

<b>18.</b>	<b>Crossing over – Factors affecting it</b>	<b>203-215</b>
<b>19.</b>	<b>Linkage</b>	<b>216-224</b>
<b>20.</b>	<b>Numerical chromosomal aberrations (Polyploidy)</b>	<b>225-246</b>
<b>21.</b>	<b>Structural chromosomal aberrations.</b>	<b>247-251</b>

## Lecture 1

### 01. HISTORY OF GENETICS

The **history of genetics** started with the work of the Augustinian friar Gregor Johann Mendel. His work on pea plants, published in 1866, described what came to be known as Mendelian Inheritance. In the centuries before—and for several decades after—Mendel's work, a wide variety of theories of heredity proliferated.

1900 marked the "rediscovery of Mendel" by Hugo de Vries, Carl Correns and Erich von Tschermak, and by 1915 the basic principles of Mendelian genetics had been applied to a wide variety of organisms—most notably the fruit fly *Drosophila melanogaster*. Led by Thomas Hunt Morgan and his fellow "drosophilists", geneticists developed the Mendelian model, which was widely accepted by 1925. Alongside experimental work, mathematicians developed the statistical framework of population genetics, bringing genetic explanations into the study of evolution.

With the basic patterns of genetic inheritance established, many biologists turned to investigations of the physical nature of the gene. In the 1940s and early 1950s, experiments pointed to DNA as the portion of chromosomes (and perhaps other nucleoproteins) that held genes. A focus on new model organisms such as viruses and bacteria, along with the discovery of the double helical structure of DNA in 1953, marked the transition to the era of molecular genetics.

In the following years, chemists developed techniques for sequencing both nucleic acids and proteins, while others worked out the relationship between the two forms of biological molecules: the genetic code. The regulation of gene expression became a central issue in the 1960s; by the 1970s gene expression could be controlled and manipulated through genetic engineering. In the last decades of the 20th century, many biologists focused on large-scale genetics projects, sequencing entire genomes.

### HISTORICAL DEVELOPMENTS IN GENETICS

Year	Scientist	Contribution
1485	L. da Vinci	Recommended the use of lenses for viewing small objects
1590	Z. Janssen and H. Janssen	Produced the first operational microscope.
1665	R. Hooke	Introduced the term “ cell ” and described cork cells.
1668	F. Redi	Disproved the theory of spontaneous generation of maggots.
1672	Malpighi	Classified the tissues.
1674	A.van Leeuwenhoek	Improved lens system of microscope by grinding.
1682	N. Crew	Described bladders and pores in wood and pith.
1694	J.R. Camerarius	Conducted early experiments on pollination and reported the existence of sex in plants.
1700	R. Linnaeus	Classified the biological organisms.
1761	J.C. Kolreuter	Hybridized various species of tobacco and concluded that each parent contributed equally to the characteristics of the progeny.
1779	C.F Wolff	Founder of embryology.
1809	J.B. Lamarck	Coined the word “ biology ” and stressed the importance of cell in living organisms. He put forth the theory of inheritance of acquired characters.
1824	Dutrochet	Showed that all plants and animals are composed of cells.
1825	F.V. Raspail	Developed the frozen-section technique and used iodine for detection of starch.
1835	H. von Mohli	Emphasized the importance of protoplasm and described cell division.
1837	R. Brown	Discovered the nucleus in cells of flowering plants.

<b>Year</b>	<b>Scientist</b>	<b>Contribution</b>
1838	M.J. Schleiden and T. Schwann	Formulated the cell theory in plants and animals.
1840	J.E. Purkinj	Gave the term “ protoplasm ”.
1845	A. Donne	Used photomicroscopy for the first time.
1846	K. Nageli	Showed that plant cells arise from the division of pre-existing cells.
1846	G.B. Amici	Showed that egg in the ovary is stimulated to develop into an embryo by the entrance of pollen tube.
1858	R. Virchow	Showed that animal cells arise from the division of pre-existing cells.
1859	C. Darwin	Put forth the theory of natural selection.
1862	Kolliker	Used the term “ cytoplasm ”for the living material surrounding the nucleus.
1865	G. Mendel	Developed the fundamental principles of heredity.
1870	W. His	Invented the microtome.
1871	F. Meischer	Isolated nucleic acids from pus cells.
1873	H. Fol	Described spindle and astral rays.
1875	O. Hertwig	Studied reproduction in sea urchins and concluded that fertilization involves the union of sperm and egg nucleus.
1875	E. Strasburger	Discovered cell division in plants and gave the terms “ cytoplasm ” and “ nucleoplasm ”.
1879	W. Flemming	Introduced the term “ chromatin ”.
1879	H. Fol	Showed that only one sperm enters the egg during fertilization.
1881	E.G. Balbiani	Discovered giant chromosomes in salivary glands of Drosophila.
1882	W. Flemming	Coined the term “ mitosis ” .
1883	W. Rouse	Proposed that chromosomes contain genes which are the units of heredity.

<b>Year</b>	<b>Scientist</b>	<b>Contribution</b>
1885	A.F.W. Schimper	Introduced the term “ plastids ”.
1888	Th. Boveri	Coined the term “ centrosomes ”.
1888	W. Waldeyer	Coined the term “ chromosomes ”.
1892	O. Hertwig	Proposed the protoplasm theory of inheritance.
1892	J. Ruckert	Described lamp brush chromosomes in oocytes of shark.
1892	W. Weisman	Stated that chromosomes are the most important part of the nucleus.
1892	Th. Boveri	Described meiosis in Ascaris.
1898	C. Golgi	Described the golgi apparatus in nerve cells.
1898	C. Benda	Discovered mitochondria in spermatozoa and other cells.
1899	S. Altman	Introduced the term “ nucleic acid ”.
1900	C.E. Correns, H. de Vries and E. Tschermak	Re-discovered Mendel’s laws of inheritance.
1901	E. Strasburger	Introduced the term “ plasmodesmata ”.
1902	C.E. McClung	Identified sex chromosomes in bugs.
1902	H. de Vries	Coined the term “ mutation ”.
1902	W.S. Sutton Th. Boveri	Proposed the chromosome theory of heredity and identified chromosomes as carriers of genetic material.
1903	W. Waldeyer	Proved centromeres are the chromosomal regions with which the spindle fibres become associated during mitosis
1905	L.Cuenot	Discovered lethal genes affecting coat colour in mice.
1905	J.B. Farmer and J.E. Moore	Coined the term “ meiosis ”.
1906	W. Bateson	Coined the term “ Genetics ”and proposed the concept of allele.
1906	W. Bateson and R.C. Punnet	Discovered genetic linkage in sweet pea.



<b>Year</b>	<b>Scientist</b>	<b>Contribution</b>
1906	W.L. Johannsen	Coined the terms “gene”, “genotype” and “phenotype”.
1909	W. Bateson	Coined the term “epitasis”.
1909	C. Correns	Reported cytoplasmic inheritance in <i>Mirabilis jalapa</i> .
1909	F.A. Janssens	Indicated that chiasmata are produced by exchanges between non-sister chromatids of homologous chromosomes.
1910	T.H. Morgan	Studied crossing over and recombination in <i>Drosophila</i> and coined the term “crossing over”.
1910	H. Nilsson-Ehle	Proposed the multiple factor hypothesis.
1911	A.H. Sturtevant	Constructed the first linkage map in <i>Drosophila</i> .
1912	Vejdovsky	Coined the term “chromonema”.
1915	T.H. Morgan	Correlated genetic studies with cytological studies. He put forth the theory of linkage and studied sex linked inheritance in <i>Drosophila melanogaster</i> .
1917	C.E. Allen	Discovered sex determination in plants.
1921	F.G. Banting C.H. Best	Isolated insulin.
1922	C.B. Bridges	Put forth the genic balance theory of sex determination.
1923	C.B. Bridges	Discovered duplications, deletions and translocations in chromosomes.
1923	Crew	Reported complete reversal of sex in hens.
1924	A.F. Blakeslee and J. Belling	Studied trisomics in Jimson weed ( <i>Datura stramonium</i> ).
1924	R. Feulgen	Described a test to confirm the presence of DNA.
1926	A.H. Sturtevant	Discovered inversions in chromosomes.
1927	G.K. Karpechenko	Synthesized Raphano brassica.
1927	H.J. Muller	Induced mutations in <i>Drosophila melanogaster</i> by X-rays
1928	L.J. Stadler	Induced mutations in maize and barley by X-rays.

Year	Scientist	Contribution
1928	F. Griffith	Conducted experiments on transformations in <i>Diplococcus pneumonia</i> .
1931	C. Stern	Gave cytological proof for crossing over in <i>Drosophila</i> .
1931	H. Creighton and B. McClintock	Gave cytological proof for crossing over in maize.
1932	M. Knoll and E. Ruska	Developed the electron microscope.
1933	M. Rhodes	Reported cytoplasmic male sterility in corn.
1935	F. Zernicke	Developed the phase contrast microscope.
1935	R.B. Goldschmidt	Coined the term “ phenocopy ”.
1939	R.A. Steinberg	Induced mutations in <i>Aspergillus</i> sp. with chemicals.
1944	O.T. Avery, C.M. MacLeod and M. McCarty	Explained the significance of DNA and proved that it is the genetic material.
1946	C. Auerbach and J.M. Robson	Induced mutations in <i>Drosophila melanogaster</i> using chemicals.
1946	E.S. McFadden, E.R. Sears and H. Kihara	Synthesized <i>Triticum spelta</i> in the laboratory.
1948	K.R. Porter	Described the endoplasmic reticulum.
1950	B. McClintock	Discovered jumping genes in maize.
1951	A. Muntzing	Synthesized Triticale.
1952	A.D. Hershey and M.J. Chase	Provided experimental proof of DNA as genetic material.
1953	Robinson and Brown	Observed ribosomes in plant cells.
1953	J.D. Watson, F.H.C. Crick and M.H.F. Wilkins	Proposed the double helix model for DNA molecule.
1954	E.R. Sears	Produced monosomic series of “Chinese Spring ” variety of wheat.
1955	S. Benzer	Described the fine structure of gene—Cistron, Recon and Muton.

<b>Year</b>	<b>Scientist</b>	<b>Contribution</b>
1955	C. DeDuve	Coined the term “ lysosomes ”.
1955	G.E. Palade	Observed ribosomes in animal cells.
1955	L. Pauling	Studied the relationship between the structure of the DNA molecule and protein synthesis.
1958	G.W. Beadle, E.L. Tatum and J. Lederberg	Put forth the one gene – one enzyme hypothesis.
1958	F.H.C. Crick	Explained the central dogma of molecular biology.
1958	M.S. Meselson and F.W. Stahl	Proved experimentally that DNA replicates by semi-conservative mechanism.
1959	A. Kornberg and S. Ochoa	Synthesized the DNA molecule in vitro.
1961	A.E. Jacob and J. Monod	Explained the genetic regulatory mechanism in protein synthesis – Operon concept.
1968	N.W. Nirenberg , H.G. Khorana and H. Holley	Deciphered the genetic code and polynucleotide synthesis.
1968	Woodcock and Fernandez	Isolated DNA from chloroplasts.
1974	Clande, G.E. Palade and C. DeDuve	Re-discovered a number of cell organelles by electron microscope.
1975	R. Dulbecco, H. Temin and D. Baltimore	Discovered the mechanism of reverse transcription – Teminism.
1975	N. Borlaug	Responsible for development of dwarf wheat and green revolution.
1978	D. Nathans , H.O. Smith and W. Arber	Isolated restriction enzymes.
1985	Potrykus	Used electroporation technique for direct gene transfer in plants.
1986	Helentzaris	Developed the RFLP map in maize and tomato.

<b>Year</b>	<b>Scientist</b>	<b>Contribution</b>
1986	Ow	Transferred and studied the expression of gene for enzyme lucifersase (causes fire flies to glow) in tobacco cells.
1987	Fischoff	Developed insect resistant transgenic tomato plants with Bt gene.
1987	K.B. Mullis	Developed polymerase chain reaction technique.
1988	Ouozzo	Developed transgenic tobacco with CMV coat protein.
1991	Oeller	Developed transgenic tomato with an antisense gene.
1992	Vasil	Developed herbicide resistant transgenic wheat.
1993	Sharp Roberts	Proposed the split gene concept.
1993	Smith	Studied site directed mutagenesis.
1994	Gilman and Rodbell	Studied G proteins and their role in turning external signals into action within cells.
1995	Lewis, Volard and Wieschaus	Studied the role of genes in organ differentiation.
1997	I. Wilmut	Cloned sheep – Dolly.
1997	Prusiner	Studied prions – Mad cow disease.
1998	Delta & Pine Co.	Developed the terminator gene technology.
1998	Monsanto Co.	Developed bollguard variety of cotton.
1998	T. Wakayama and R. Yanagimachi	Created the first cloned mice.
2000	Roslin Institute	Created the first cloned pigs.
2001	Advanced Cell Technology	Birth of first cloned Asian ox called “Gaur”.
2002	Natl. Institute of Agronomic Research, France.	Created the first cloned rabbit



**MENDEL'S LAWS OF INHERITANCE AND EXCEPTIONS TO THE LAWS****History**

The assertion that life can instantaneously arise from non living matter is called spontaneous generation. Here are the critical experiments that busted the myth. Although today we understand that living things arise from other living things, the idea of spontaneous generation was entrenched in the minds of man throughout most of history. Spontaneous generation is the belief that, on a daily basis, living things arise from non living material. This debunked belief is not the same as abiogenesis, the study of how life on earth could have arisen from inanimate matter billions of years ago.

**Aristotle and Spontaneous Generation (383-322)**

Aristotle was one of the first to record his conclusions on the possible routes to life. He saw beings as arising in one of three ways, from sexual reproduction, asexual reproduction or nonliving matter. According to Aristotle, it was readily observable that aphids arise from the dew on plants, fleas from putrid matter, and mice from dirty hay; and this belief remained unchallenged for more than two thousand years.

**Francesco Redi's Experiments (late 1600s)**

Redi was an Italian physician and one of the first to formally challenge the doctrine of spontaneous generation. Redi's question was simple, "Where do maggots come from?" According to spontaneous generation, one would conclude that maggots came from rotting food. Redi hypothesized that maggots came from flies and designed an experiment, elegant in its simplicity, to challenge spontaneous generation.

Redi put meat into three separate jars:

Jar #1 he left open. He observed flies laying eggs on the meat and the eventual development of maggots.

Jar #2 he covered with netting. Flies laid their eggs on the netting and maggots soon appeared.

Jar #3 he sealed. Flies were not attracted to this jar and no maggots developed on the meat. This seems to be a clear demonstration of life giving rise to life. Yet it took another two hundred years for people to accept spontaneous generation as a fallacy.

**Anthony van Leeuwenhoek's "Animalcules" (1600-1700s)**

**Leeuwenhoek** was a Dutch cloth merchant, and due to his trade, he frequently used lenses to examine cloth. Rather than employing lenses made by others, he ground his own, and the expertise that he gained through lens crafting combined with a curious mind eventually led

to an interest in microscopy. During his life, Leeuwenhoek assembled more than 250 microscopes, some of which magnified objects 270 times. Through magnification, he discovered presence of “micro” organisms - organisms so tiny that they were invisible to the naked eye. He called these tiny living things “animalcules,” and was the first to describe many microbes and microscopic structures, including bacteria, protozoans and human cells.

### **John Needham & Lazzaro Spallanzani (1700s)**

The debate over spontaneous generation was reignited with Leeuwenhoek’s discovery of animalcules and the observation that these tiny organisms would appear in collected rainwater within a matter of days. John Needham and Lazzaro Spallanzani both set out to examine Leeuwenhoek's animalcules.

#### **Needham’s Experiment**

John Needham was a proponent of spontaneous generation, and his beliefs were confirmed when, after boiling beef broth to kill all microbes, within the span of a few days, cloudiness of the broth indicated the respawning of microscopic life.

#### **Spallanzani’s Experiment**

Lazzaro Spallanzani noted a flaw in Needham’s experiment. The containers holding Needham’s beef broths had not been sealed upon boiling. So Spallanzani modified Needham’s experiment, boiling infusions, but immediately upon boiling he melted the necks of his glass containers so that they were not open to the atmosphere. The microbes were killed and did not reappear unless he broke the seal and again exposed the infusion to air.

### **Louis Pasteur (1800s)**

Pasteur, a French scientist who made great contributions to our understanding of microbiology and for whom the process of “pasteurization” is named, repeated experiments similar to those of Spallanzani’s and brought to light strong evidence that microbes arise from other microbes, not spontaneously.

#### **Pasteur’s Swan-Necked Flasks**

Pasteur created unique glass flasks with unusual long, thin necks that pointed downward. These “swan-necked” flasks allowed air into the container but did not allow particles from the air to drift down into the body of the flask.

#### **The End of Spontaneous Generation**

After boiling his nutrient broths, Pasteur found that these swan-necked containers would remain free of microbes until he either broke the necks of the flasks, allowing particles from the air to drift in, or until he tilted the flask so that the liquid came in contact with dust that had accumulated at the opening of the flask. It was these carefully controlled experiments of Pasteur

that finally put to rest the debate over spontaneous generation.

### **Preformation theory (Swammerdam and Bonnet. 1720 1793)**

Preformation theory proposes that the only male and female is responsible for heredity. The male gamete consists of a miniature figure of man's body called as homunculus which is responsible for heredity. Epigenesis (C.f.wolf (1733-1794) and K.E. Von Baer (1792-1876) said that the different organs and tissues of adult plant and animals developed from the uniform embryonic tissue and not from mere growth expansion of the miniature homunculi present in eggs / sperms. Von Baer proposed that they developed through a sequential modification of the embryonic tissue. This concept is universally accepted.

Swammerdam (1637-1680), for example, thought that a tiny preformed frog occurred in the animal hemisphere of the frog egg and that became simply larger by feeding on the food stored in the vegetal hemisphere of the egg. Another biologist, Hartsoeker (1695) published a figure showing a miniature man known as mankin or homunculus in the head of the human spermatazoa. Such preformation theories had been supported by Leeuwenhoek (1632-1723), Malpighi (1673), Reaumur, Bonnet (1720- 1793), Spallanzani (1729-1799) and other workers of 17th and early 18th centuries. With the development of improved microscopy and other cytological techniques in 17th and 18th centuries, it became clear to biologists that neither the egg nor the sperm contained a preformed individual but that each was a relatively uniform, homogeneous mass of protoplasm.

### **Particulate Theory**

A French biologist Maupertius in 1698-1759 discards the preformation theory and forwarded the concept of biparental through many tiny particles. According to him both the parents produce the semen, which composed of many tiny particles. The semen of both the parents unite and the embryo formed each organ of the embryo was supposed to be formed by two particles. Each of which came from each parent. In the year 1732-1806 J.C. Koelreuter was the first person to get fertile hybrids by artificial crossing two species of tobacco and concluded that the gametes were the physical basis of heredity.

### **Pangenesis**

Charles Darwin proposed this theory. According to pangenesis that each organ of an individual produces very small almost invisible identical copies of itself called gemmules or pangenes. These gemmules from various parts collected into the blood stream of animals. The blood transports the gemmules into the reproductive organ, which produce gametes. Male and female gametes unite to form zygotes. When these gives rise to a new organism, the gemmules of different parts of the body give rise to the same kind of organs, tissues and cells, which



produced them in the parents.

### **Lamarckism**

A French biologist Lamarck (1774-1829) considered the inheritance of acquired characters to be the most important, if not the sole, mechanism of evolutionary changes. According to urgent need, use and disuse of organs, the modification thus acquired will be transmitted to their off spring.

### **Germplasm theory August Weismanís (1834-1914)**

Germplasm theory explains that body of individual consists of two distinct types of tissues, (1) somatoplasm (2) germplasm. Somatoplasm consists of all body tissues, which do not contribute to the sexual reproduction. The germplasm on the other hand produces gametes that are the basis of heredity. It is only applied to animals and plants in which distinction between soma and germ can be made. Weismannís famous experiment of cutting off the tail of mice for 22 generations and observing that the progeny still had tail of normal length, proved that the somatoplasm is not responsible for transmission of characters.

### **Cell Theory(1838)**

Schleiden and Schwann proposed cell theory 1838. They concluded that all plant and animal tissues were made of cells. It was also postulated that cell is the functional unit of living organism. In 1846 Negeli said that all cells originated from preexisting cells. Virchow 1853 elaborated this and referred it as cell linkage theory.

### **Mendelian concept of hereditary**

The laws of inheritance were derived by Gregor Mendel, a 19th century monk conducting hybridization experiments in garden peas (*Pisum sativum*). Between 1856 and 1863, he cultivated and tested some 29,000 pea plants. From these experiments he deduced two generalizations which later became known as *Mendel's Laws of Heredity* or *Mendelian inheritance*. He described these laws in a two part paper, "Experiments on Plant Hybridization" that he read to the Natural History Society of Bruno on February 8 and March 8, 1865, and which was published in 1866.

Mendel's findings allowed other scientists to predict the expression of traits on the basis of mathematical probabilities. A large contribution to Mendel's success can be traced to his decision to start his crosses only with plants he demonstrated were true-breeding. He also measured only absolute (binary) characteristics, such as color, shape, and position of the offspring, rather than quantitative characteristics. He expressed his results numerically and subjected them to statistical analysis. His method of data analysis and his large sample size gave credibility to his data. He also had the foresight to follow several successive generations

(f<sub>2</sub>, f<sub>3</sub>) of his pea plants and record their variations. Finally, he performed "test crosses" (back-crossing descendants of the initial hybridization to the initial true-breeding lines) to reveal the presence and proportion of recessive characters. Without his careful attention to procedure and detail, Mendel's work could not have had the impact it made on the world of genetics.

### Mendel's Laws

Mendel discovered that by crossing white flower and purple flower plants, the result was not a hybrid offspring. Rather than being a mix of the two, the offspring was purple flowered. He then conceived the idea of heredity units, which he called "factors", one which is a recessive characteristic and the other dominant. Mendel said that factors, later called genes, normally occur in pairs in ordinary body cells, yet segregate during the formation of sex cells. Each member of the pair becomes part of the separate sex cell. The dominant gene, such as the purple flower in Mendel's plants, will hide the recessive gene, the white flower. After Mendel self-fertilized the F<sub>1</sub> generation and obtained the 3:1 ratio, he correctly theorized that genes can be paired in three different ways for each trait; AA, aa, and Aa. The capital **A** represents the dominant factor and lowercase **a** represents the recessive.

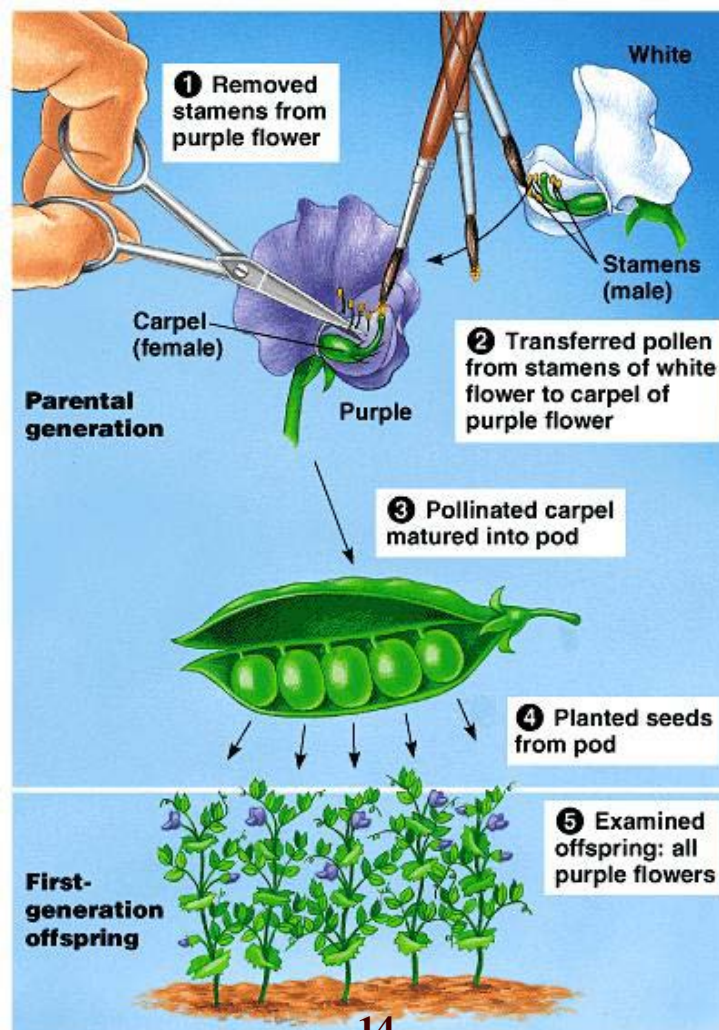

Mendel stated that each individual has two factors for each trait, one from each parent. The two factors may or may not contain the same information. If the two factors are identical, the individual is called **homozygous** for the trait. If the two factors have different information, the individual is called **heterozygous**. The alternative forms of a factor are called **alleles**. The genotype of an individual is made up of the many alleles it possesses. An individual's physical appearance, or phenotype, is determined by its alleles as well as by its environment. An individual possesses two alleles for each trait; one allele is given by the female parent and the other by the male parent. They are passed on when an individual matures and produces gametes: egg and sperm. When gametes form, the paired alleles separate randomly so that each gamete receives a copy of one of the two alleles. The presence of an allele doesn't promise that the trait will be expressed in the individual that possesses it. In heterozygous individuals the only allele that is expressed is the dominant. The recessive allele is present but its expression is hidden. Mendel summarized his findings in two laws; the **Law of Segregation** and the **Law of Independent Assortment**.

### **Law of Segregation (The "First Law")**

The Law of Segregation states that when any individual produces gametes, the copies of a gene separate, so that each gamete receives only one copy. A gamete will receive one allele or the other. The direct proof of this was later found when the process of meiosis came to be known. In meiosis the paternal and maternal chromosomes get separated and the alleles with the characters are segregated into two different gametes.

### **Law of Independent Assortment (The "Second Law")**

The Law of Independent Assortment, also known as "**Inheritance Law**", states that alleles of different genes assort independently of one another during gamete formation. While Mendel's experiments with mixing one trait always resulted in a 3:1 ratio between dominant and recessive phenotypes, his experiments with mixing two traits (dihybrid cross) showed 9:3:3:1 ratios. But the 9:3:3:1 table shows that each of the two genes are independently inherited with a 3:1 ratio. Mendel concluded that different traits are inherited independently of each other, so that there is no relation, for example, between a cat's color and tail length. This is actually only true for genes that are not linked to each other.

Independent assortment occurs during meiosis I in eukaryotic organisms, specifically metaphase I of *meiosis*, to produce a gamete with a mixture of the organism's maternal and paternal chromosomes. Along with chromosomal crossover, this process aids in increasing genetic diversity by producing novel genetic combinations.

In independent assortment the chromosomes that end up in a newly-formed gamete are randomly sorted from all possible combinations of maternal and paternal chromosomes. Because gametes end up with a random mix instead of a pre-defined "set" from either parent, gametes are therefore considered assorted independently. As such, the gamete can end up with any combination of paternal or maternal chromosomes. Any of the possible combinations of gametes formed from maternal and paternal chromosomes will occur with equal frequency. For human gametes, with 23 pairs of chromosomes, the number of possibilities is  $2^{23}$  or 8,388,608 possible combinations. The gametes will normally end up with 23 chromosomes, but the origin of any particular one will be randomly selected from paternal or maternal chromosomes. This contributes to the genetic variability of progeny.

### **Rediscovery of Mendel's work**

Mendel's conclusions were largely ignored. Although they were not completely unknown to biologists of the time, they were not seen as generally applicable, even by Mendel himself, who thought they only applied to certain categories of species or traits. A major block to understanding their significance was the importance attached by 19<sup>th</sup> century biologists to the apparent blending of inherited traits in the overall appearance of the progeny, now known to be due to multigene interactions, in contrast to the organ-specific binary characters studied by Mendel. In 1900, however, his work was "re-discovered" by three European scientists, Hugo de Vries, Carl Correns, and Erich von Tschermak. The exact nature of the "re-discovery" has been somewhat debated: De Vries published first on the subject, mentioning Mendel in a footnote, while Correns pointed out Mendel's priority after having read De Vries's paper and realizing that he himself did not have priority. De Vries may not have acknowledged truthfully how much of his knowledge of the laws came from his own work, or came only after reading Mendel's paper. Later scholars have accused Von Tschermak of not truly understanding the results at all. Regardless, the "re-discovery" made Mendelism an important but controversial theory. Its most vigorous promoter in Europe was William Bateson, who coined the term "genetics", "gene", and "allele" to describe many of its tenets.

The model of heredity was highly contested by other biologists because it implied that heredity was discontinuous, in opposition to the apparently continuous variation observable for many traits. Many biologists also dismissed the theory because they were not sure it would apply to all species, and there seemed to be very few true Mendelian characters in nature. However, later work by biologists and statisticians such as R.A. Fisher showed that if multiple Mendelian factors were involved in the expression of an individual trait, they could produce the diverse results observed. Thomas Hunt Morgan and his assistants later integrated the

theoretical model of Mendel with the chromosome theory of inheritance, in which the chromosomes of cells were thought to hold the actual hereditary material, and create what is now known as classical genetics, which was extremely successful and cemented Mendel's place in history.

### Mendel's Laws of Inheritance

Mendel postulated three laws, which are now called after his name as Mendel's laws of heredity. These are:

1. Law of dominance and recessive
2. Law of segregation
3. Law of independent assortment

#### 1. Law of Dominance

**Definition:** When two homozygous individuals with one or more sets of contrasting characters are crossed, the characters that appear in the  $F_1$  hybrids are dominant characters and those do not appear in  $F_1$  are recessive characters.

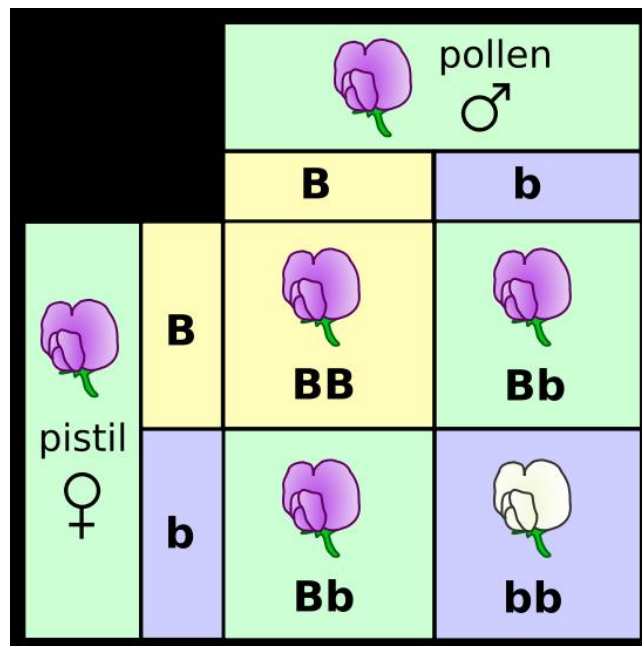

Law of dominance- If there are two alleles coding for the same trait and one is dominant it will show up in the organism while the other won't

**Explanation :** The dominance and recessive of genes can be explained on the basis of enzymatic functions of genes. The dominant genes - are capable of synthesizing active polypeptides or proteins that form functional enzymes, whereas the recessive genes (mutant

genes) code for incomplete or non-functional polypeptides. Therefore, the dominant genes produce a specific phenotype while the recessive genes fail to do so. In the heterozygous condition also the dominant gene is able to express itself, so that the heterozygous and homozygous individuals have similar phenotype.

### **Critical appreciation of Law of Dominance**

Scientists conducted cross-breeding experiments to find out the applicability of law of dominance. The experiments were conducted by Correns on peas and maize, Tschermak on peas, by De Vries on maize etc., by Bateson and his collaborators on a variety of organisms, by Davenport on poultry, by Furst on rabbits, by Toyama on silk moth and by many others. These scientists observed that a large number of characters in various organisms are related as dominant and recessive.

### **Importance of law of dominance**

The phenomenon of dominance is of practical importance as the harmful recessive characters are masked by the normal dominant characters in the hybrids. In Human beings a form of idiocy, diabetes, haemophilia etc. are recessive characters. A person hybrid for all these characteristics appears perfectly normal. Thus harmful recessive genes can exist for several generations without expressing themselves.

Exceptions to Law of Dominance is the Incomplete Dominance. After Mendel several cases were recorded by scientists, where  $F_1$  hybrids exhibited a blending of characters of two parents. These hybrids were found to be midway between the two parents. This is known as incomplete dominance or blending inheritance. It means that two genes of the allelomorphic pair are not related as dominant and recessive, but each of them expresses itself partially. As for example, in four-o'clock plant, *Mirabilis jalapa*, when plants with red flowers (RR) are crossed with plants having white flowers (rr), the hybrid  $F_1$  plants (Rr) bear pink flowers. When these  $F_1$  plants with pink flowers are self-pollinated they develop red (RR), pink (Rr) and white (rr) flowered plants in the ratio of 1 : 2 : 1 ( $F_2$  generation).

## **2. Law of Segregation (Purity of Gametes)**

**Explanation** - The law of segregation states that when a pair of contrasting factors or genes or allelomorphs are brought together in a heterozygote (hybrid) the two members of the allelic pair remain together without being contaminated and when gametes are formed from the hybrid, the two separate out from each other and only one enters each gamete.

Example - Pure tall plants are homozygous and, therefore/possess genes (factors) TT; similarly dwarf possess genes tt. The tallness and dwarfness are two independent but contrasting factors or



determiners. Pure tall plants produce gametes all of which possess gene T and dwarf plants t type of gametes.

During cross fertilization gametes with T and t unite to produce hybrids of F<sub>1</sub> generation. These hybrids possess genotype Tt. It means F<sub>1</sub> plants, though tall phenotypically, possess one gene for tallness and one gene for dwarfness. Apparently, the tall and dwarf characters appear to have become contaminated developing only tall character. But at the time of gamete formation, the genes T (for tallness) and t (for dwarfness) separate and are passed on to separate gametes. As a result, two types of gametes are produced from the heterozygote in equal numerosity. 50% of the gametes possess gene T and other 50% possess gene t. Therefore, these gametes are either pure for tallness or for dwarfness. (This is why the law of segregation is also described as Law of purity of gametes).

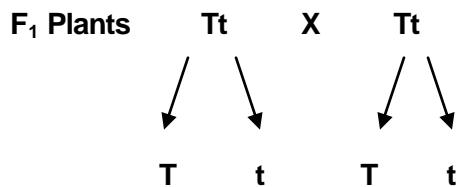

Gametes unite at random and when gametes are numerous all possible combinations can occur, with the result that tall and dwarf appear in the ratio of 3 :1. The results are often represented by Punnett square as follows:

**Critical appreciation of law of segregation**

It has been confirmed by cytological studies that dominance or no dominance, the law of segregation holds good to all cases. Its far reaching applicability has made it rare biological generalization.

- RR                    have only gene for round
- Rr, rR                have gene for round and wrinkle
- Rr                    have only wrinkled gene

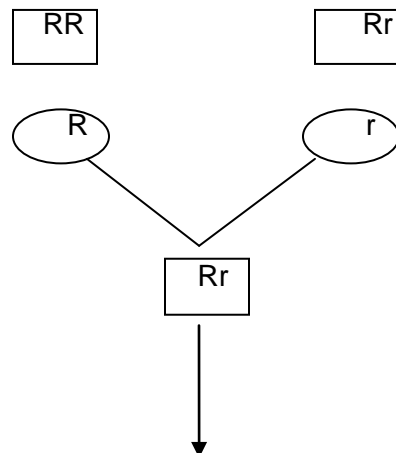

	R	r
R	RR	Rr
r	Rr	rr

Round, Wrinkled - 3:1 ratio

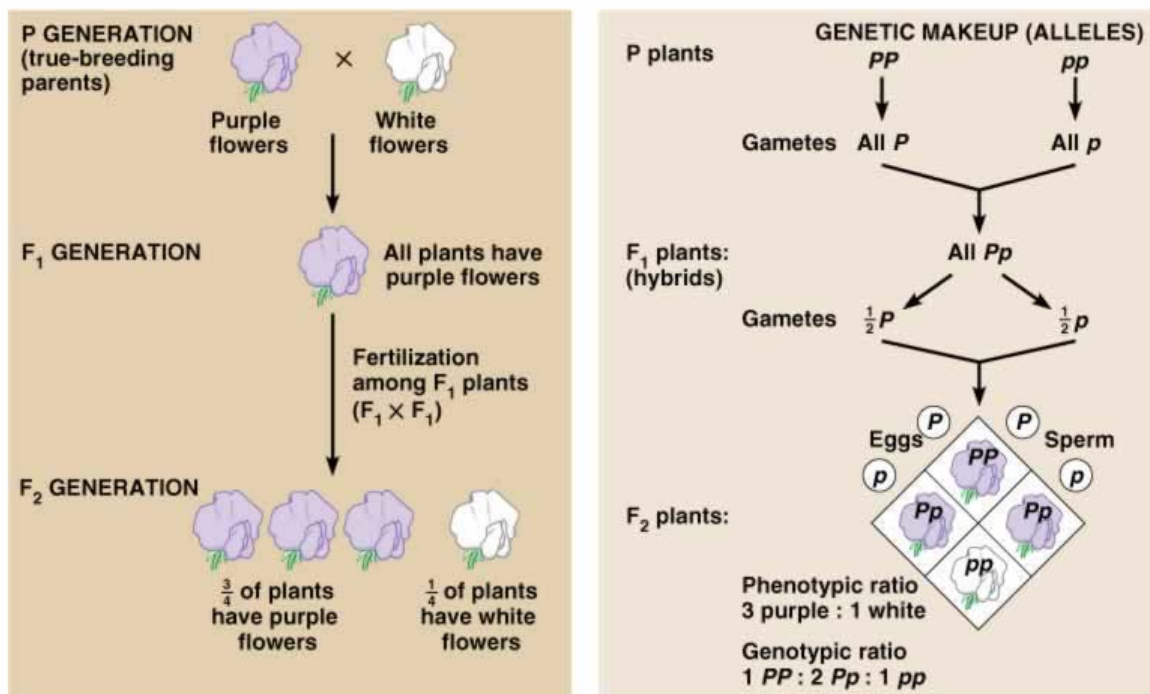

### 3. Law of Independent Assortment

**Definition:** The inheritance of more than one pair of characters (two pairs or more) is studied simultaneously, the factors or genes for each pair of characters assort out independently of the other pairs. Mendel formulated this law from the results of a dihybrid cross.

**Explanation:** The cross was made between plants having yellow and round cotyledons and plants having green and wrinkled cotyledons.

The F<sub>1</sub> hybrids all had yellow and round seeds. When these F<sub>1</sub> plants were self fertilized they produced four types of plants in the following proportion:

- (i) Yellow and round                      9



## Principles of Genetics

- |                          |   |
|--------------------------|---|
| (ii) Yellow and wrinkled | 3 |
| (iii) Green and round    | 3 |
| (iv) Green and wrinkled  | 1 |

The above results indicate that yellow and green seeds appear in the ratio of  $9 + 3 : 3 + 1 = 3 : 1$ . Similarly, the round and wrinkled seeds appear in the ratio of  $9 + 3 : 3 + 1 = 12:4$  or  $3 : 1$ . This indicates that each of the two pairs of alternative characters *viz.* yellow-green cotyledon colour is inherited independent of the round-wrinkled character of the cotyledons. It means at the time of gamete formation the factor for yellow colour enters the gametes independent of R or r, i.e. gene Y can be passed on to the gametes either with gene R or r.

**Cytological explanation of the results:** In the above experiment yellow and round characters are dominant over green and wrinkled characters which can be represented as follows:

















- |  |   |
|--|---|
| (i) gene for yellow colour of cotyledons       | Y |
| (ii) gene for green colour of cotyledons       | y |
| (iii) gene for round character of cotyledons   | R |
| (iv) gene for wrinkled character of cotyledons | r |





Therefore, plants with yellow and round cotyledons will have their genotype YYRR and those with green and wrinkled cotyledons will have a genotype yyrr. These plants will produce gametes with gene YR and yr respectively. When these plants are cross pollinated, the union of these gametes will produce F<sub>1</sub> hybrids with YyRr genes. When these produce gametes all the four genes have full freedom to assort independently and, therefore, there are possibilities of four combinations in both male and female gametes.





- |       |         |          |         |
|-------|---------|----------|---------|
| (i)RY | (ii) Ry | (iii) rY | (iv) ry |
|-------|---------|----------|---------|

This shows an excellent example of independent assortment. These gametes can unite at random producing in all 16 different combinations of genes, but presenting four phenotypes in the ratio of 9: 3: 3: 1.

**Dihybrid ratio :** RR yy - Round, yellow seeded ; Rr yy - Wrinkled and green seeded

		♂ gametes			
		$R Y$ $\frac{1}{4}$	$R y$ $\frac{1}{4}$	$r y$ $\frac{1}{4}$	$r Y$ $\frac{1}{4}$
♀ gametes	$R Y$ $\frac{1}{4}$	$RR YY$ $\frac{1}{16}$ 	$RR Yy$ $\frac{1}{16}$ 	$Rr Yy$ $\frac{1}{16}$ 	$Rr YY$ $\frac{1}{16}$ 
	$R y$ $\frac{1}{4}$	$RR Yy$ $\frac{1}{16}$ 	$RR yy$ $\frac{1}{16}$ 	$Rr yy$ $\frac{1}{16}$ 	$Rr Yy$ $\frac{1}{16}$ 
	$r y$ $\frac{1}{4}$	$Rr Yy$ $\frac{1}{16}$ 	$Rr yy$ $\frac{1}{16}$ 	$rr yy$ $\frac{1}{16}$ 	$rr Yy$ $\frac{1}{16}$ 
	$r Y$ $\frac{1}{4}$	$Rr YY$ $\frac{1}{16}$ 	$Rr Yy$ $\frac{1}{16}$ 	$rr Yy$ $\frac{1}{16}$ 	$rr YY$ $\frac{1}{16}$ 

9  : 3  : 3  : 1 

 Round, yellow	 Wrinkled, yellow
 Round, green	 Wrinkled, green

### Test cross

F1  $Rr Yy$  x  $rr yy$  (recessive)  
 1:1:1:1

### Critical appreciation of law of Independent Assortment-

The law of independent assortment fails to have a universal applicability. Cytological studies have revealed that only those allelomorphs assort independently during meiosis, which are located in different homologous pairs of chromosomes. But, if the allelomorphs for different characters are present in the same homologous pair of chromosomes, these are passed on to the same gamete. Law of independent assortment does not apply to such cases.

### BIOLOGICAL SIGNIFICANCE OF MENDEL'S LAWS

Mendel's work remained buried for about three decades, but after its rediscovery, the laws are being used for the various branches of breeding. These are used for improving the varieties of fowls and their eggs; in obtaining rust-resistant and disease-resistant varieties of grains. Various new breeds of horses and

dogs are obtained by cross breeding experiments. The science of Eugenics is the outcome of Mendelism, which deals with the betterment of human race.

**Mendelian deviation**

Mendelian deviations or exceptions or anomalies includes

- 1) Incomplete dominance
- 2) Codominance
- 3) Lethal genes etc.

**1. Incomplete dominance**

Mendel always observed complete dominance of one allele over the other for all the seven characters, which he studied, in garden pea. Later on cases of incomplete dominance were reported. For example, in four o' clock plant (*Mirabilis jalapa*) there are two types of flower viz., red and white. A cross between red and white flowered plants produced plants with intermediate flower colour i.e. pink colour in F1 and a modified ratio of 1 red: 2 pink: 1 White in F2.

**Parents**                      Red flower x                      White flower  
    RR                      x                      rr  
**F1**    Rr                      pink flower  
**F2**                      1 Red (RR) : 2 Pink (RR) : 1 White (rr)

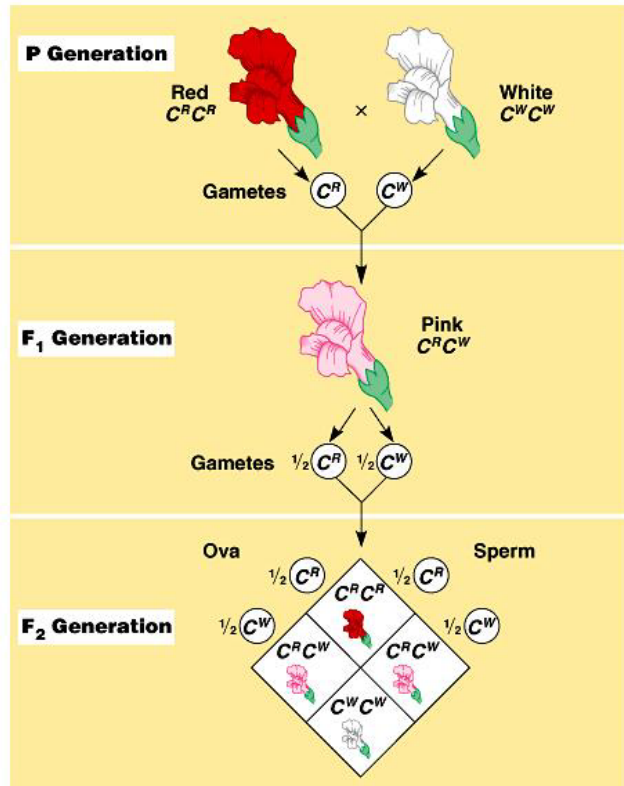

**Incomplete dominance in flowers of *Mirabilis jalapa***

### 2. Codominance

In case of codominance both alleles express their phenotypes in heterozygote greater than an intermediate one. The example is AB blood group in human. The people who have blood type AB are heterozygous exhibiting phenotypes for both the  $I^A$  and  $I^B$  alleles. In other words, heterozygotes for codominant alleles are phenotypically similar to both parental types. The main difference between codominance and incomplete dominance lies in the way in which genes act. In case of codominance both alleles are active while in case of incomplete dominance both alleles blend to make an intermediate one.

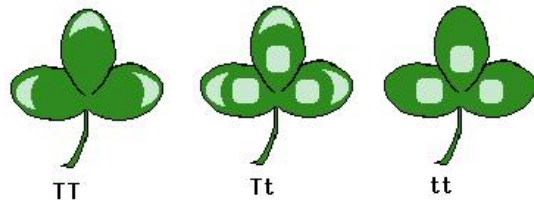

Codominance - both genes fully expressed

### 3. Lethal genes

Gene, which causes the death of its carrier when in homozygous condition is called lethal gene. Mendel's findings were based on equal survival of all genotypes. In normal segregation ratio of 3:1 is modified into 2:1 ratio. Lethal genes have been reported in both animals as well as plants. In mice allele for yellow coat colour is dominant over grey. When a cross is made between yellow and grey a ratio of 1:1 for yellow and gray mice was observed. This indicated that yellow mice are always heterozygous. Because yellow homozygotes are never born because of homozygous

lethality. Such genes were not observed by Mendel. He always got 3:1 ratio in F<sub>2</sub> for single gene characters.

Lethal genes can be recessive, as in the aforementioned mouse experiments. Lethal genes can also be dominant, conditional, semilethal, or synthetic, depending on the gene or genes involved.

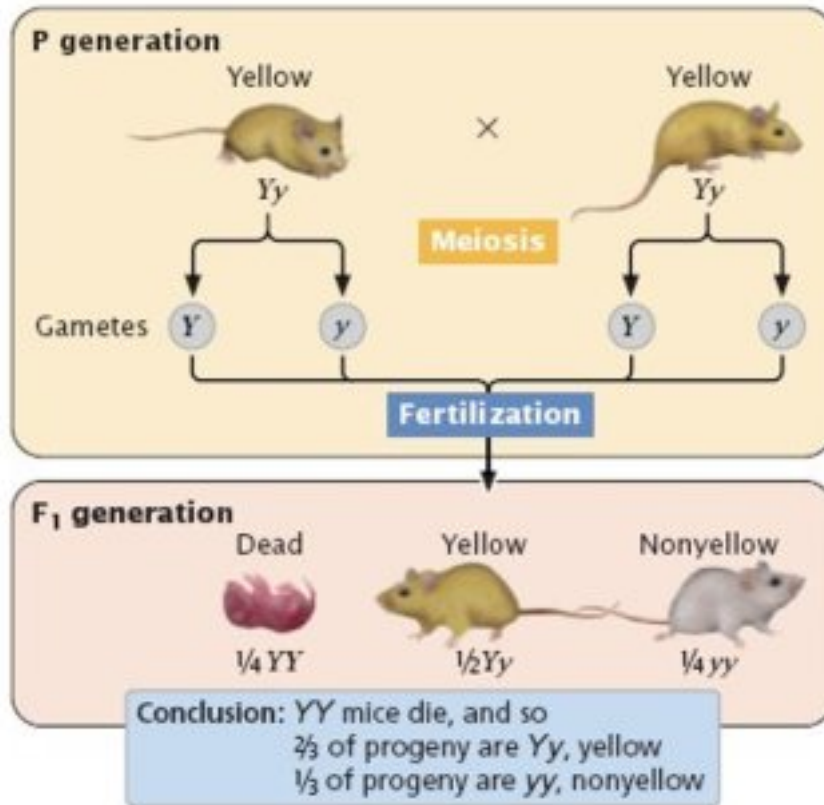

### MONOHYBRID CROSS

A cross is made between two true-breeding parents differing for a single trait, producing an F<sub>1</sub> generation. These plants are intercrossed to produce an F<sub>2</sub> generation.

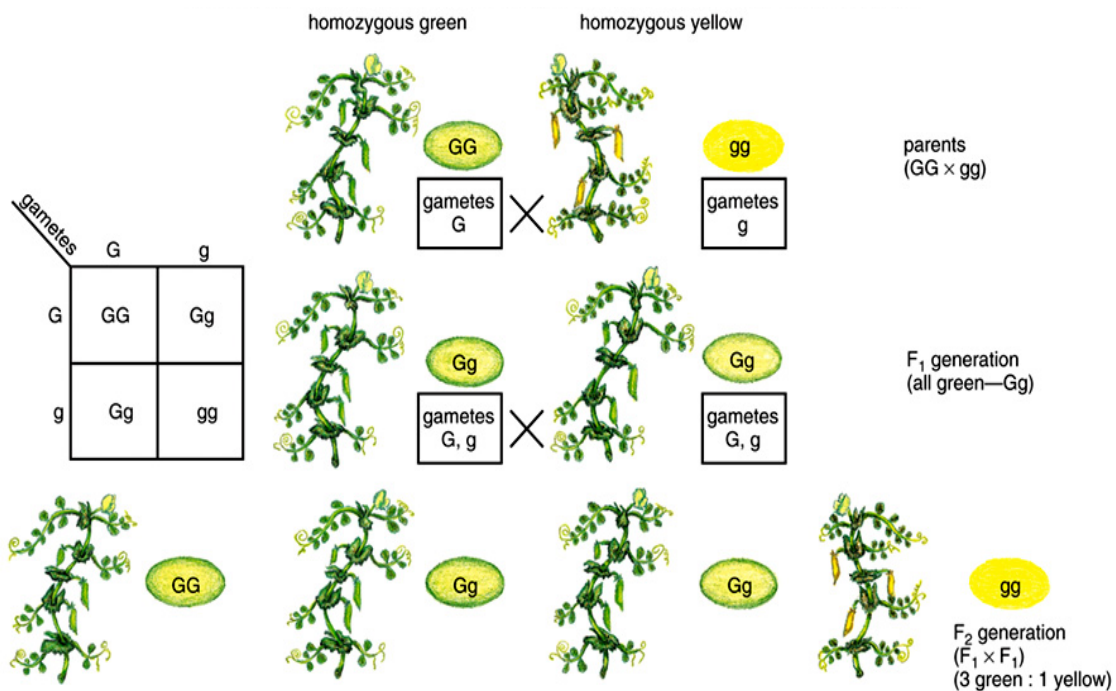

**Dihybrid Crosses**

The following legends were described for peas by Mendel:

- T- Tall
- tt - dwarf
- G - green (pod)
- gg- yellow

Pure breeding parents can be crossed to produce a dihybrid meaning that 2 genes affecting different traits are heterozygous (segregating) in all the f1 progeny.

Examples: TT, GG X tt, gg       $\longrightarrow$       Tt, Gg  
 TT, gg X tt, GG       $\longrightarrow$       Tt, Gg

When the F1 is self fertilized (plants) or crossed with another Tt, Gg individual, the progeny will show the expected 3 dominant : 1 recessive phenotypic ratio for each trait. If the two traits are independent, the two 3 : 1 ratios will interact to give a ratio based on 16ths.

#	Genotypes	Phenotypes
9	T_, G_	Tall, Green
3	T_, gg	Tall, yellow
3	tt, G_	Dwarf, Green
1	tt, gg	Dwarf, Yellow

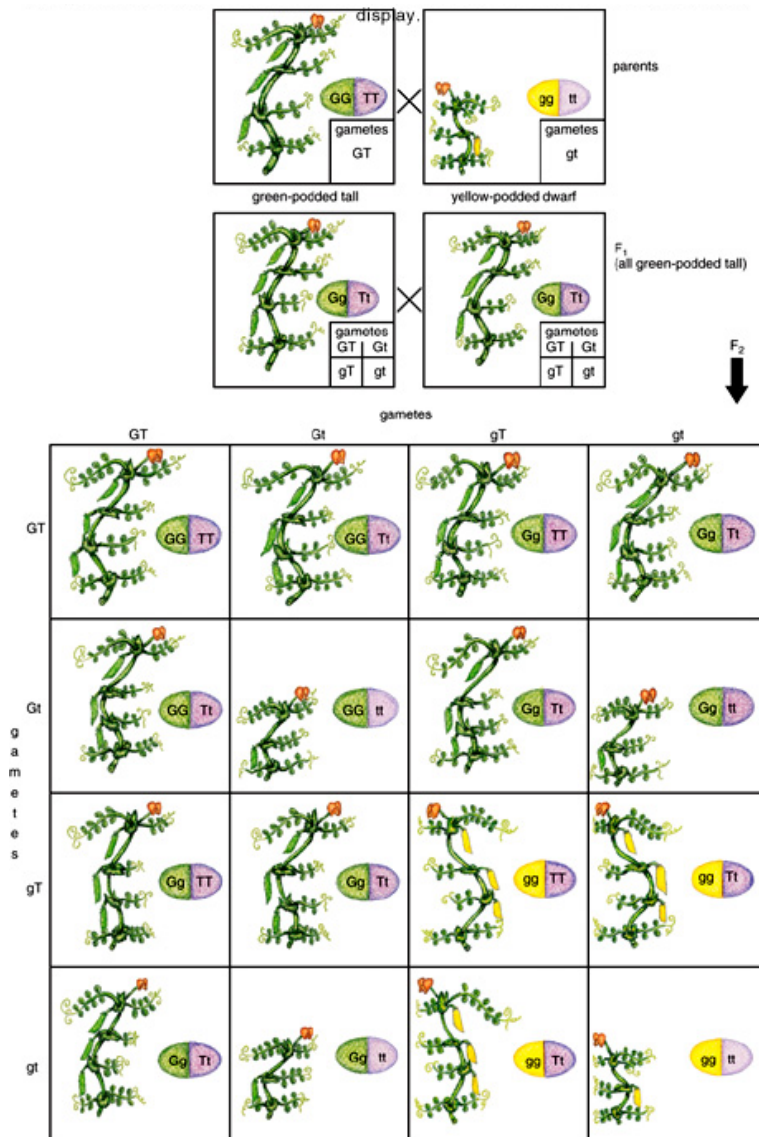

### Backcross

**Backcrossing** is a crossing of a hybrid with one of its parents or an individual genetically similar to its parent, in order to achieve offspring with a genetic identity which is closer to that of the parent.

### The Testcross

Because some alleles are dominant over others, the phenotype of an organism does not always reflect its genotype. A recessive phenotype (yellow) is only expressed with the organism is homozygous recessive (gg). A pea plant with green pods may be either homozygous dominant (GG) or heterozygous (Gg). To determine whether an organism with a dominant



## Principles of Genetics

phenotype (e.g. green pod color) is homozygous dominant or heterozygous, you use a *testcross*.

The breeding of an organism of unknown genotype with a homozygous recessive. If all the progeny of the testcross have green pods, then the green pod parent was probably homozygous dominant since a GG x gg cross produces Gg progeny. If the progeny of the testcross contains both green and yellow phenotypes, then the green pod parent was heterozygous since a Gg x gg cross produces Gg and gg progeny in a 1:1 ratio. The testcross was devised by Mendel and is still an important tool in genetic studies.

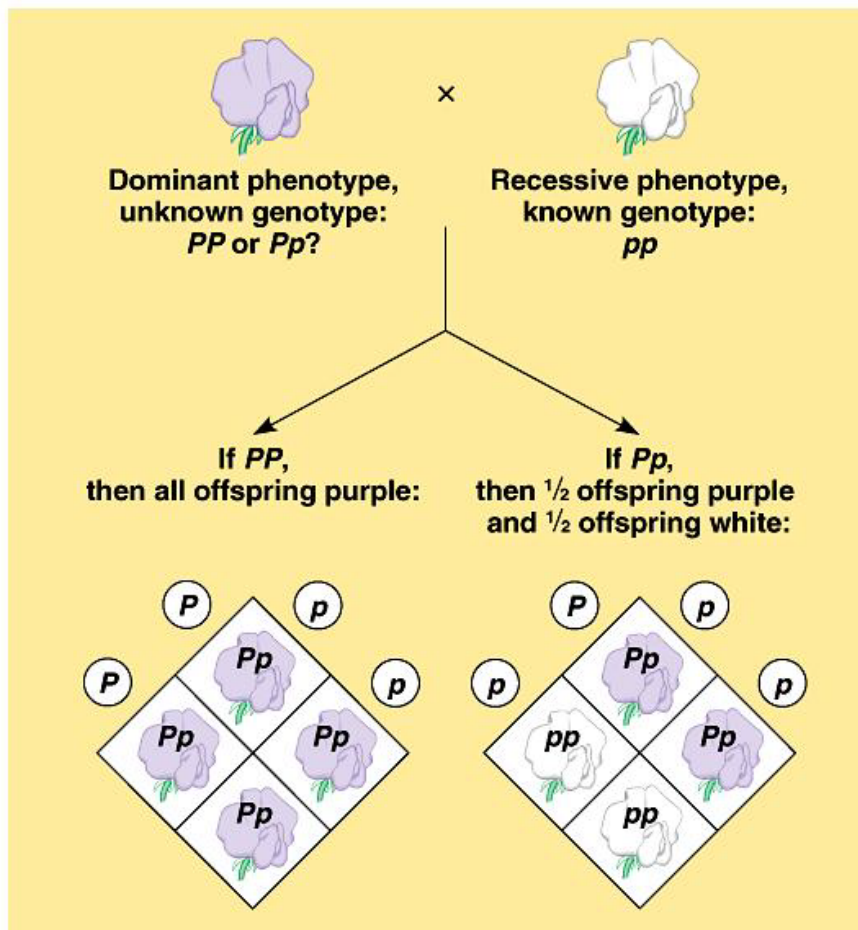



**TYPES OF GENE ACTION**

The interaction with in alleles of gene controlling a single character may be dominant, incomplete dominance and co-dominance and are called intra allele interaction. When there is a interaction occurs between different pairs of alleles influencing a character of an individual is said to be interallelic interaction or epistatic. The gene that has masking effect is called epistatic gene, and the gene whose effect is masked is known as hypostatic gene. Epistasis leads to modification of normal dihybrid or trihybrid segregation ratio in F<sub>2</sub> generation.

The term epistasis was coined by Bateson in 1909. Various types of epistatic gene interaction are

- 1) Recessive epistasis (9:3:4)
- 2) Dominant epistasis (12:3:1)
- 3) Dominant and recessive (inhibitory) epistasis (13:3)
- 4) Duplicate recessive epistasis (9:7)
- 5) Duplicate dominant epistasis (15:1) and
- 6) Polymeric gene interaction (9:6:1).

**Dihybrid ratio (9:3:3:1)**

A classical case of two genes affecting the one and the same character and producing in the F<sub>2</sub> four different phenotypes in the ratio of 9:3:3:1 was discovered in fowls by Bateson and Punnett. Each breed of poultry possesses characteristic type of comb. The Wyandotte breed has a comb known as the **rose** comb, the Brahma has a **pea** comb, and the leghorn has a **single** comb and the Malaya **walnut** comb. Each of these breeds true. Cross between rose comb and single combed types show that rose is dominant to single comb and that there is a segregation of 3 rose: 1 single comb in the F<sub>2</sub>. In mating between pea combed with single combed and 3:1 ratio appears in F<sub>2</sub>. In mating between pea combed with single combed bird, pea combed is found to be dominant over single comb and 3:1 ratio appears in F<sub>2</sub>. When a rose combed fowl is crossed with a pea combed one, all the F<sub>1</sub> birds show a new comb known as walnut comb. When the walnut combs are inbred there appears in F<sub>2</sub> walnut 3 rose pea single comb. As well in the ratio of 9:3:3:1. The rose comb is due to the presence of R gene and Pea due to P gene. Walnut comb is due to the presence of the dominant genes. R and P and single comb are due to the presence of recessive of r and p. The ratio expected in F<sub>2</sub> is 9:3:3:1.

Parent            RR PP            x            rrpp  
                   Rose            x            rp

Rr pp(Walnut)

♀ \ ♂	RP	Rp	rP	rp
RP	RRPP (W)	RRPp (W)	RrPP (W)	RrPp (W)
Rp	RRPp (W)	RRpp (R)	RrPp (W)	Rrpp (R)
rP	RrPP (W)	RrPp (W)	rrPP (P)	rrpp (P)
rp	RrPp (W)	Rrpp (R)	rrPp (P)	rrPP (S)

9 Walnut: 3 Rose: 3 Pea: 1 Single

**Duplicate recessive epistasis (Complimentary gene action) 9:7**

When recessive alleles at either of the two loci can mask the expression of dominant alleles at the two loci, it is called duplicate recessive epistasis. This is also known as complementary epistasis. The best example of duplicate recessive epistasis is found for flower colour in sweet pea. The purple colour of flower in sweet pea is governed by two dominant genes say A and B when these genes are in separate individuals (Aabb or aaBB) and white (aabb) they produce white flower. A cross between purple flower (AABB) and white flower (aabb) strains produced purple colour in F1 intermating of F1 plants produced purple and white flower plants in 9:7 ratio in F2 generation. Here the recessive allele 'a' is epistatic to B/b alleles and mask the expression of these alleles, another recessive allele 'b' is epistatic to A/a alleles and mask their expression.

## Principles of Genetics

Parents                      purple                      x                      White  
    AABB                      x                      aabb  
    AB    ab  
    AaBb  
    Purple

♂	AB	Ab	aB	ab
♀	AB	Ab	aB	ab
AB	AABB (P)	AABb (P)	AaBB (P)	AaBb (P)
Ab	AABb (P)	AAbb (W)	AaBb (P)	Aabb (W)
aB	AaBB (P)	AaBb (P)	aaBB (W)	aaBb (W)
Ab	AaBb (P)	Aabb (W)	aaBb (W)	aabb (W)

Ratio = 9 Purple : 7 white

### Duplicate gene action (15:1) (Duplicate dominant epistasis)

When a dominant allele at either of two loci can mask the expression of recessive alleles at the two loci, it is known as duplicate dominant epistasis. In rice awn character is controlled by two dominant duplicate genes (A and B). Presence of any of these two alleles can produce awn. The awnless condition develops only when both these genes are in homozygous recessive state (aabb). A cross between awned and awnless strains produced awned plants in F1. Intermating of F1 plants produced awned and awnless plants in 15:1 ratio in F2 generation. The allele A is epistatic to a/b alleles and all plants having allele A will develop awn. Another dominant allele B is epistatic to alleles a/b. An individual with these allele also develop awn character.

Parents awned rice                      x                      awnless rice  
    AAbb                      x                      aaBB  
    AaBb  
    Awned rice

♀ ♂	AB	Ab	aB	ab
AB	AABB (A)	AABb (A)	AaBB (A)	AaBb (A)
Ab	AABb (A)	AAbb (A)	AaBb (A)	Aabb (A)
aB	AaBB (A)	AaBb (A)	aaBB (A)	aaBb (A)
ab	AABb (A)	AAbb (A)	AaBb (A)	Aabb (a)

Ratio = 15 awned : 1 awnless

**Inhibitory gene action (13:3)**

In this type of epistasis, a dominant allele at one locus can mask the expression of both (dominant and recessive) alleles at second locus. This is also known as inhibitory gene interaction. An example of this type of gene interaction is found for anthocyanin pigmentation in rice. The green colour of plants is governed by the gene I which is dominant over purple colour. The purple colour is controlled by a dominant gene P. when a cross was made between green (IiPp) and (iiPP) colour plants, the F1 was green. Intimating of F1 plants produced green and purple plants in 13:3 ratio in F2.

Parents awned rice x awnless rice  
 AAbb x aaBB  
 AaBb  
 Awned rice

♀ ♂	IP	Ip	iP	ip
IP	IIPP (G)	IIPp (G)	IiPP (G)	IiPP (G)
Ip	IIPp (G)	Ippp (G)	IiPp (G)	Iipp (G)
iP	IiPP (G)	IiPp (G)	IiPP (P)	IiPp (P)
ip	IiPp (G)	Iipp (G)	IiPp (P)	Iipp (G)

Ratio = 13 Green : 3 Purple

**Supplementary gene action. (Recessive epistasis) 9:3:4**

Here one dominant gene has its own phenotypic effect and other dominant gene has no effect of its own but its presence with the first gene modified the phenotypic expression. Thus in supplementary gene action the dominant allele of one gene is necessary for the development of the concerned phenotype, while the other gene modifies the expression of the first gene.

Parents      RR PP      x      rr pp  
                  Purple      Red  
                  RP                      rp  
                  Rr Pp  
                  Purple

♂	RP	Rp	RP	Rp
♀	RP	Rp	rP	rp
RP	RRPP (P)	RRPp (P)	RrPP (P)	RrPP (P)
Rp	RRPp (P)	RRpp (W)	RrPp (P)	Rrpp (W)
rP	RrPp (P)	RrPp (P)	RrPP (R)	RrPp (R)
rp	RrPp (G)	Rrpp (W)	rrPp (RP)	rrpp (W)

**Ratio = 9 Purple : 3 Red : 4 White**

**Additive factors (9:6:1) (Polymeric gene action)**

In these two genes controlling a character produces identical phenotype when they are alone i.e. with the homozygous recessive condition of the other gene. But when both the genes are present together, their phenotype effect is enhanced as if the effect of the two genes were cumulative or additives. It should be noted that in this case both the genes show complete dominance. If the two genes showing polymeric gene action, what will be the consequence. In barley two completely dominant genes A and B affect the length of awns, the thin needle like extension of lemma genes A and B alone (e.g. Aabb and aaBB give gives rise to awn of medium length, the effect of A is the same as that of B. But when both the genes A and B are present together they produce long awn indicating the effect of A and B genes of awn length are added together. Individual homozygous recessive for both these genes are awn less.

Parents                      AA BB              x              aa bb  
 Long awned                  x                  awnless  
    Aa Bb  
 Long awned

♂	AB	Ab	aB	ab
♀	AB	Ab	aB	ab
AB	AABB (L)	AABb (L)	AaBB (L)	AaBB (L)
Ab	AABb (L)	AAbb (A)	AaBb (L)	Aabb (A)
aB	AaBB (L)	AaBb (L)	aaBB (A)	aaBb (A)
ab	AaBb (L)	Aabb (A)	aaBb (A)	aabb (a)

Ratio = 9 Long awned: 6 Awned: 1 awnless

**11. Dominant Epistasis (12:3:1)**

An example of dominant epistasis is found for fruit colour viz white, yellow and green. White colour is controlled by dominant gene W and yellow colour by dominant genes G. White is codominant over both yellow and green. The green fruits are produced in recessive condition (wwgg). A cross between plants having white and yellow fruits produced F1 with white fruits. Intermating of F1 plants produced plants with white, yellow and green coloured fruits in F2 was 12:3:1 ratio. Here W is dominant to w and epistatic to alleles G and g. Hence it will mask the expression of G.g alleles. Hence in F2 plants with W-G- (9:16) and W-gg (3:16) genotypes will produce white fruits; plants with wwG-3/16 will produce yellow fruits and those with wwgg 1/16 genotype will produce green fruits. Thus the normal dihybrid ration 9:3:3:1 is modified to 12:3:1 ratio in 1:2 generation. Similar type of gene interaction has been reported for skin colour in mice and seed coat colour in barley.

Parents              White fruit              x              Yellow fruit  
                             WWgg                      x                  wwGG  
    **WwGg White fruit**

♂ ♀	WG	Wg	wG	wg
Wg	WWGG (W)	WWGg (W)	WwGG (W)	WwGG (W)
Wg	WWGg (W)	WWgg (W)	WwGg (W)	Wwgg (W)
WG	WwGG (W)	WwGg (W)	wwGG (Y)	WwGg (Y)
Wg	WwGg (W)	Wwgg (W)	wwGg (Y)	wwgg <b>(G)</b>

Ratio = 12 White: 3 Yellow: 1 Green

### Modifying genes

These are group of genes, which enhances or reduce the phenotypic effect of a major gene. Such genes have small and cumulative effect on the expression of the major genes. As a result continuous variation is generated in the phenotype governed by a single major gene, which converts qualitative character into a quantitative one. In rats, guinea pigs and rabbits, piebald spotting is produced by recessive genes when present in a homozygous state (ss). The degree of spotting depends upon the modifying factors, designed as S1, S2, S3 etc. which enhances or reduces the expression of this spotting gene with cumulative on spotting. Most quantitative characters of crop plants may be determined in a similar fashion. Some modifying genes affect more than one character.

### Major and minor genes

In the pie bald spotting the modifying factors produce some spotting even in the absence of the spotting genes but their effect is much more pronounced in the presence of s, Obviously the spotting gene s is a major gene controlling spotting, while the modifying genes are minor genes affecting this trait.

### **Inheritance of quantitative characters**

#### **Concept of polygenes**

Colour, sex etc which shows distinct categories are known as qualitative characters. They are usually governed by one or major genes or oligogenes. Characters like length of ear in corn, yield of grain, yield of milk, stature etc do not fall into clear cut classes and shown more or less continuous variation and are governed by a large number of minor genes called multiple genes or polygenes. The characteristic feature of quantitative characters is 1) continuous variation and 2) a marked influence of the environment on their expression.

#### **Multiple factor hypothesis (Nilsson - Ehle 1908)**

He effected crosses between different true breeding strains of wheat with red kernels and with white kernel and the result of F<sub>1</sub> and F<sub>2</sub> were obtained. The F<sub>1</sub> was (medium) red In F<sub>2</sub> 15:1 ratio was obtained. Careful examination revealed that the red colour of F<sub>1</sub> was not as intense as the red colour of the parent and that in the F<sub>2</sub> some red grains were as dark as those of the parent and other only as dark as those of the F<sub>1</sub>. F<sub>2</sub> plants revealed marked difference in the intensity of colour depending upon the ratio of dominant and recessive genes present in them. Thus he obtained 1:4:6:4:1 ratio for dark red, medium dark red medium red, light red and white. It is evident that red colour is due to two pairs of genes. Each gene is capable of producing red colour. Each is incompletely dominant over white and is cumulative in its effect. The intensity of the red color depends upon the number of colour producing genes present. Dark red is due the presence of four genes for red medium dark red to three genes, medium red, to two genes and light red to one gene.

Nilson Ehle from his studies proposed the multiple gene hypothesis for the inheritance of quantitative characters. This assumes that there is a series of independent genes for a given quantitative traits. Dominance is usually incomplete and there is a strength of expression of the character, whereas its alleles do not posses any effect. The F<sub>1</sub> essentially uniform but intermediate between the two parents. The F<sub>2</sub> shows considerable variability, but is intermediate between the two parents. The F<sub>2</sub> mean value being approximately equal to the parental mean and also the F<sub>1</sub> mean. Studies on *Nicotiana* (East and Emerson 1916) worked on quantitative characters to explain the inheritance of corolla length in *nicotiana longiflora*. He crossed two inbred with contrasting corolla length of 40 and 93 mm. The F<sub>1</sub> was intermediate with mean corolla length of 63 mm. In F<sub>2</sub> a much larger variation for corolla length than the parents and F<sub>1</sub> was observed. This variation was continuous as well and the F<sub>2</sub> mean was close to that of F<sub>1</sub> and intermediate between those of the parent. This is precisely what is expected in case of polygenic inheritance.



### **Transgressive segregation**

The appearance in F<sub>2</sub> individuals with higher or lower intensity of characters than the parents is called as transgressive segregation. It is produced when the parents have positive alleles of different genes affecting a quantitative traits and segregation of these genes produce two extreme homozygotes in F<sub>2</sub>, which transgress the parental limit for the character. The reappearance of ancestor is called atavism, throw back or reversion.

### **Expressivity**

The degree of phenotypic expression of a penetrant gene is called expressivity. In other words, the ability of a gene to produce identical phenotypes in all the individuals carrying it in the appropriate genotype is known as incomplete expressivity. Many genes have incomplete expressivity, while the wild type (normal) alleles are buffered against such variations.

### **Penetrance**

The frequency with which a gene produces a phenotypic or visible effect in the individuals, which carry it, is known as penetrance. In other words penetrance refers to the proportion of individuals which exhibit phenotypic effect of a specific gene carried by them. In general genes express themselves in all the individuals in which they are present in the appropriate genotype is known as penetrance. It indicates the number of individuals that give the expected phenotype to any degree.

### **Polydactyly**

Polydactyly is a condition with extra fingers and toe or toes in man is due to the presence of dominant gene P. The normal condition is produced by the genotype PP. The genotype and pp produce polydactyly. Some heterozygous individual are not polydactyly. (Pp). Therefore the gene has penetrance of less than 100 per cent and said to be incompletely penetrant. A gene though penetrant, may be quite variable in its expression. The degree of expression produced by a penetrant genotype is termed expressivity. The polydactylous condition may be penetrant in the left hand and not in the right hand or may be penetrant in the feet and not in hands.

**MULTIPLE ALLELES**

Allele is a shorter term than allelomorph (another form) is the alternate form of gene. Many genes have two alternate forms but several other have more than two alternate forms. More than two alleles at the same locus give rise to a multiple allelic series. Multiple alleles can be defined as a series of forms of a gene situated at the same locus of homologous chromosomes. According to Mendel, each gene had two alternate forms or allele morphs are being dominant and the other being recessive. Dominant being the wild type from which recessive mutant was evolved through mutation. Likewise, a wild type can mutate in many ways and produce many mutant forms and a mutant can again undergo another mutation and give rise to a new mutant. Hence, a gene can exist in more than two allelomorphs. Usually wild type allele is dominant over its recessive allele. wild allele is represented as + .

Multiple alleles can be defined as a

- series of forms of a gene
- situated at the same locus of homologous chromosomes
- affecting same character.

Multiple alleles are

- different forms of the same gene
- that is the sequence of the bases is slightly different in the genes located on the same place of the chromosome.

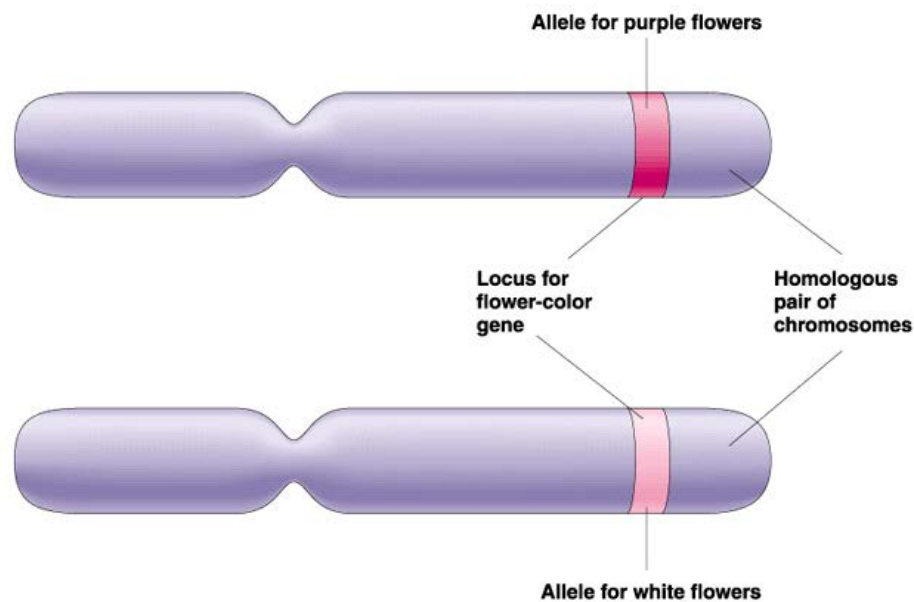

## Principles of Genetics

Multiple alleles are alternative states at the same locus. Remember: each individual will only have two alleles for a trait but there are several alleles to choose from.) The classical example for multiple alleles is human blood group self incompatibility in tobacco, coat colour in rabbit, self incompatibility genes in brassica.

The number of possible genotypes in a series of multiple alleles is  $\frac{1}{2} n (n+1)$

$n$  = no of alleles

- Di-allelic genes can generate 3 genotypes.
- Genes with 3 alleles can generate 6 genotypes.
- Genes with 4 alleles can generate 10 genotypes.
- Genes with 8 alleles can generate 36 genotypes

### Important features of multiple alleles

- 1) Multiple alleles always belong to the same locus and one allele is present at a locus at a time in a chromosome
- 2) Multiple alleles always control the same character of an individual
- 3) Wild type allele is dominant over other alleles
- 4) There is no crossing over in the multiple alleles
- 5) In a series of multiple alleles wild type is always dominant
- 6) When two mutant types are crossed wild form cannot be recovered
- 7) The cross between two mutant alleles will always produce mutant phenotype. Examples of multiple alleles are 1) fur colour in a rabbit, 2) ABO blood group in man 3) Wing type in drosophila 4) Eye colour in drosophila etc. Fur colour in Rabbit. In rabbit, three alternate forms of genes, which controls coat colour. C causes wild type and its alleles.

### Skin colour in rabbit

In rabbits, four kinds of skin colour are known.

Possible genotypes	$CC, Cc^{ch}, Cc^h, Cc$	$c^{ch}c^{ch}$	$c^{ch}c^h, c^hc$	$c^hc^h, c^hc$	$cc$
Phenotype	Dark gray	Chinchilla	Light gray	Himalayan	Albino



- $CC, Cc^{ch}, Cc^h, Cc^a$  - Agouti (wild type)  
 $c^{ch}, c^h, c^{ch}c^h, c^hc$  - Chinchilla (salivary grey hair)

## Principles of Genetics

- $c^h c^h, c^h c$  - Himalayan (white except black feet nose ear tail)  
 $cc$  - Albino (complete white).

### Agouti

This has full colour and is also known as wild type. This colour is dominant over all the remaining colour and produces agouti colour in F1 and 3:1 ratio in F2 when crossed with any of the other three colours in rabbits. C represents this colour.

### Chinchilla

This is lighter than agouti. This colour is dominant over Himalayan and albino and produces chinchilla in F1 and 3:1 ratio in F2 when crossed either Himalayan or albino. This is represented by  $c^{ch}$ .

### Himalayan

The main body is white while the tips of ear, feet, tail and snout are coloured. This colour is dominant over albino and produces 3:1 ratio in F2 when crossed with albino. This is represented by  $c^h$ .

### Albino

This has pure white fur colour and is recessive to all other types. This is represented by c. Thus the order of dominance for fur colour in rabbits can be represented as follows.

Agouti	Chinchilla	Himalayan	Albino
(C)	(cch)	(ch)	(c)

### ABO Blood group in man.

#### Antibody

Antibody is a type of protein, which is commonly referred to as immunoglobulin. It is usually found in the serum or plasma. The presence of antibody can be demonstrated by its specific reaction with an antigen.

#### Antigen

An antigen refers to a substance or agent, which when introduced into the system of vertebrate animal like cow, goat, man etc induces the production of specific antibody, which binds specifically to this (Antigen) substance. Antigen are located in the red blood corpuscles (RBC). If a person has a particular antigen in his RBCs, his serum has usually antibodies against the other antigen. In human RBC two types of antigens viz A and B are present. Depending upon the presence or absence of antigen A and B the blood group in man is of four types viz A, B, AB and O. A person with blood group A has antigen A on the surface of RBCs; protein with blood group B will have antigen B those with blood group AB have antigens A and B; and those with blood group O have no antigen on the surface of their RBCs.

Blood Group	Genotype	Antigen found	Antibody present	Compatible blood group
A	$I^A I^A, I^A i$	A	B	A and O
B	$I^B I^B, I^B i$	B	A	B and O
AB	$I^A I^B$	AB	None	A,B, AB,O
O	ii	None	AB	O

Recent studies shows that antigen is galactosamine and B is galactose Antibodies A, B, AB and None and are naturally present in the serum of individuals having A,B,AB, and O blood group respectively. The agglutination or coagulation of RBCs leads to clotting of blood due to interaction between antigen antibody. The blood group B cannot be transferred to an individual having blood group A because the recipient has antibody against antigen B which is present on the RBCs of blood group B. Similarly the reverse transfusion is not possible. The blood group AB does not have antibody A and B. Hence individuals with AB blood group can accept all types of blood, viz., A, B, AB and O. Such individuals are known as **universal acceptors** or recipients. The O blood group does not have any antigen and has antibody against antigen A and B, It cannot accept blood group other than O. Individuals with blood group O are known as **universal donors**, because transfusion of blood group O is possible with all the four blood types. The consideration of Rh (rhesus) type is important in blood transfusion. Each blood group has generally two types of Rh group, viz positive and negative. The same type of Rh is compatible for blood transfusion Opposite type lead to reaction resulting in death of the recipient. These are few examples of multiple alleles Now it is believed that multiple alleles are present almost for all genes.

### Multiple alleles in plants

The classical example of multiple alleles in plants is 'self incompatibility alleles' which prevents self fertilization.

### Multiple alleles in Maize

Multiple allelic series affecting seed color is seen in Maize.

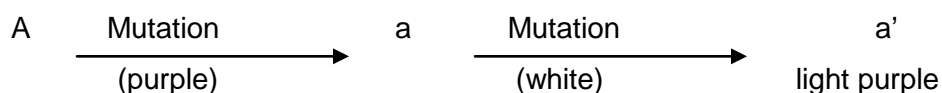

### Multiple allele in cotton

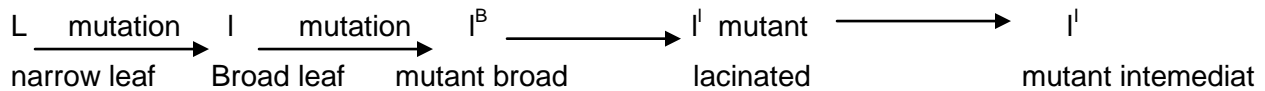

For information

- About 30% of the genes in humans are di-allelic, that is they exist in two forms.
- About 70% are mono-allelic, they only exist in one form and they show no variation.
- A very few are poly-allelic having more than two forms.

### Pleiotropism

In general one gene affects a single character. But many genes are known to affect more than one character such genes are known as pleiotropic genes and the condition is termed as pleiotrophy. An example of a pleiotropic gene in human beings is the recessive gene *s* which produces sickle cell anemia in the *ss* homozygotes. This gene causes changes in two or more parts of characters, which are not related, then the gene is said to be pleiotropic gene. E.g. In cotton the Punjab hairy lintless gene *lic* produces seeds without lint. This gene also causes incomplete lacinations of the leaf, reduction in boll size and fertility. In a plant a gene may produce red pigment in several organs, such as flowers stem, leaves but still it is not correct to say that the gene is pleiotropic because the gene has only one general effect, the production of pigment. A gene for wing may be vestigial gene can be called as bristle gene or a fecundity gene. A number of other recessive genes produce marked and often detrimental effect in human beings. They are referred as syndromes.

### Penetrance

Most genes produce identical phenotypes in all the individuals in which they are present in the appropriate genotype. For example, all the seeds having the *w* gene governing the seed shape in pea, in the homozygous state (*ww*) have uniformly wrinkled shape. Similarly, those seeds that have either *WW* or *Ww* genotype are uniformly round. The ability of a gene to produce identical phenotypes in all the individuals carrying it in the appropriate genotype is known as complete expressivity. As opposed to this, many genes have incomplete expressivity in that they produce variable phenotypes in the individuals that have this gene in the appropriate genotype.

### Expressivity

In general, genes express themselves in all the individuals in which they are present in the appropriate genotype, this is known as complete penetrance. But many genes do not

produce the concerned phenotype in all the individuals which carry them in the appropriate genotype. Such a situation is known as incomplete penetrance. When a gene is present in the appropriate genotype, the per cent of individuals in which it is able to express itself is a measure of its penetrance. Thus the chlorophyll deficiency gene in lima beans has a penetrance of 10 %. Almost all the genes showing incomplete penetrance exhibit incomplete expressivity as well. Thus incomplete penetrance is in fact an expression of incomplete expressivity in that some individuals show such a small expression of the gene that the trait is not detectable.

### **Isoalleles**

These alleles, which are similar but on testing it proves to be a different one. Blood group A person have three slightly different types such as IA1, IA2, IA3 which are similar but found to be different after testing.

### **Pseudoalleles**

The genes that are so closely linked can be separatable only by rare crossing over. Such genes are called pseudoalleles.

**MULTIPLE FACTOR HYPOTHESIS****Multiple factor**

It is quite natural that small differences exist among individuals of similar genotype due to the effect of environment on genotype. On the other hand, there are some heritable differences also exist with continuous variation. Most of the economical traits show continuous variation and they are measurable or quantifiable.

**Quantitative characters**

Quantitative characters are traits which show continuous variation and governed by a large number of genes called multiple genes or multiple factors or polymeric genes or polygenes. Their inheritance follows same mendelian principles.

**Quantitative characters**

Qualitative characters show

- discontinuous variation and
- are governed by one or two major genes or oligogones.

**Multiple factor Hypothesis (Nilson – Ehle)**

Nilson-Ehle studied Kernel colour in wheat concluded that is a quantitative character He crossed true breeding red kernel whet (RR) with true breeding white (rr) and the F1 was red (Rr) and the F2 segregated for red and white in 3:1 ratio indicating the dominance of red over white. However, careful examination indicated the variation in red color among the red color progenies. F1 red was not as intense as one of the parents. In F2 he could observe two grades of red ie. one was red as that of one of its parent, two were higher red as that of F1 individuals. In some crosses, a ratio of 15 red : 1 white was found in F2 indicating that there are **two pairs of genes** for red colour that either or both of these can produce red kernels. Finally he observed different shades of red in F2 for red kernel types. The F2 showed **red shades** and white as follows;



Dark red	:	1	
Medium dark red	:	4	
Medium red	:	6	15
Light red	:	4	
White	:	1	
<b>Total</b>	<b>:</b>	<b>16</b>	



- It was concluded two duplicate dominant alleles R1 and R2 **cumulatively decide** the intensity of red colour
- and both R1 and R2 are in completely dominant over white.
- **The high intensity of red colour depends on the number.**

The F2 ratio in wheat

Genotype	Genotypic ratio	Phenotype
R <sub>1</sub> R <sub>1</sub> R <sub>2</sub> R <sub>2</sub>	1	Dark red
R <sub>1</sub> R <sub>1</sub> R <sub>2</sub> r <sub>2</sub>	2	Medium dark red
R <sub>1</sub> r <sub>1</sub> R <sub>2</sub> R <sub>2</sub>	2	Medium dark red
R <sub>1</sub> r <sub>1</sub> R <sub>2</sub> r <sub>2</sub>	4	Medium red
R <sub>1</sub> R <sub>1</sub> r <sub>2</sub> r <sub>2</sub>	1	Medium red
r <sub>1</sub> r <sub>1</sub> R <sub>2</sub> R <sub>2</sub>	1	Medium red
R <sub>1</sub> r <sub>1</sub> r <sub>2</sub> r <sub>2</sub>	2	light red
r <sub>1</sub> r <sub>1</sub> R <sub>2</sub> r <sub>2</sub>	2	light red
r <sub>1</sub> r <sub>2</sub> r <sub>2</sub> r <sub>2</sub>	1	white

Hence, if two parents differ for the two genes the segregation was 1:4:6:4:1 provided both R1 and R2 contribute equally to the colour. If three genes are involved in F2 segregation showed 1:6:15:20:15:6:1 for red shades and 1 for white.

Thus, Nilson-Ehle's multiple factor states that

- i) For a given quantitative trait there could be several genes, which were independent in their segregation, but had cumulative effect on phenotype
- ii) Dominance is usually incomplete
- iii) **Each gene contributes something** to the strength of expression of character whereas its recessive allele does not of genes present dominance gene.

### Causes of Genetic Variation: The Multiple-factor Hypothesis

We are used to thinking about the genetics of discrete plant phenotypes, for example tall versus short peas in Mendel's experiments. In this example, variation (different alleles) at a single gene contributes to a major phenotypic difference. However, for many traits of interest (such as yield), it is often the case that a large number of genes, each of modest effect, collectively contribute to the genetic variation. This is the **multiple-factor hypothesis**.

Early support for this multiple-factor hypothesis came from H. Nilsson-Ehle (1909), a Swedish geneticist working on various cereal crops. Many of the characters that he examined yielded 3:1 ratios in the F<sub>2</sub> generation following the cross of two parental strains, consistent with expectations for a single segregating locus with one allele completely dominant over the other. However, there were some striking exceptions. For example, when red-seeded and white-seeded wheat strains were crossed, the F<sub>1</sub> progeny were identical in color (light red), but in some of the F<sub>2</sub> crosses, a ratio of 63 red:1 white seeds was observed. Nilsson-Ehle interpreted this to be the result of the segregation of three independent factors, the initial parents being *AABBCC* and *aabbcc*, all members of the F<sub>1</sub> being *AaBbCc* and hence uniform in color, and the F<sub>2</sub> consisting of all possible genotypes, only one of which (*aabbcc*) gives rise to white seed. The probability of obtaining an *aabbcc* offspring from an *AaBbCc* × *AaBbCc* cross is  $(\frac{1}{4})^3 = \frac{1}{64}$ . From these results, Nilsson-Ehle arrived at two general conclusions. First, *sexual reproduction can produce a huge diversity of genotypes*. For example, since a locus with two alleles *A* and *a* can produce three genotypes (*AA*, *Aa*, and *aa*), ten diallelic loci can produce  $3^{10} = 60,000$  genotypes. Second, given this huge potential diversity of genotypes, *apparently new types appearing within a population may be the result of rare segregants rather than new mutations*. Subsequent studies quickly confirmed these ideas. East (1911, 1916) and Emerson (1910; Emerson and East 1913) examined quantitative variation in a large number of plants. Typically, strains differing widely in some character were crossed and the variance of the resulting F<sub>1</sub> and F<sub>2</sub> generations recorded. In most of these crosses, especially when the parental populations were formed by repeated self-fertilizations, an **outbreak of variation** was seen in the F<sub>2</sub> (Figure 1.2). Such outbreaks of variation, resulting from the segregation of multiple genotypes from the F<sub>1</sub> heterozygotes, are consistent with the multiple-factor hypothesis. For example, if the two parents being crossed are inbred lines with genotypes *AABBCC* and *aabbcc*, then the resulting F<sub>1</sub> also has a single genotype *AaBbCc*. However, in the F<sub>2</sub>, all of the F<sub>1</sub> heterozygotes can segregate, so that an *Aa* parent can have *AA*, *Aa*, or *aa* offspring. Thus, the F<sub>2</sub> consists of a large collection of different genotypes, and hence is more variable (having both genetic and

environmental contributions to variation) than either of the parental or F1 lines (which have only environmental contributions to the variance).

**Figure 1.2** The distribution of ear size in the F1 and F2 generations formed by crossing two inbred lines of corn differing in ear length. The observed number of ears is given below each size class. The variation seen in the P1, P2 and F1 populations is due entirely to environmental factors, as all individuals in each population have the same genotype. These three populations show roughly similar amounts of variation. In contrast, the F2 generation shows considerably more variation, reflecting the diversity of genotypes in this population generated by segregation of genes in the F1 parents. (Data from East 1911.).

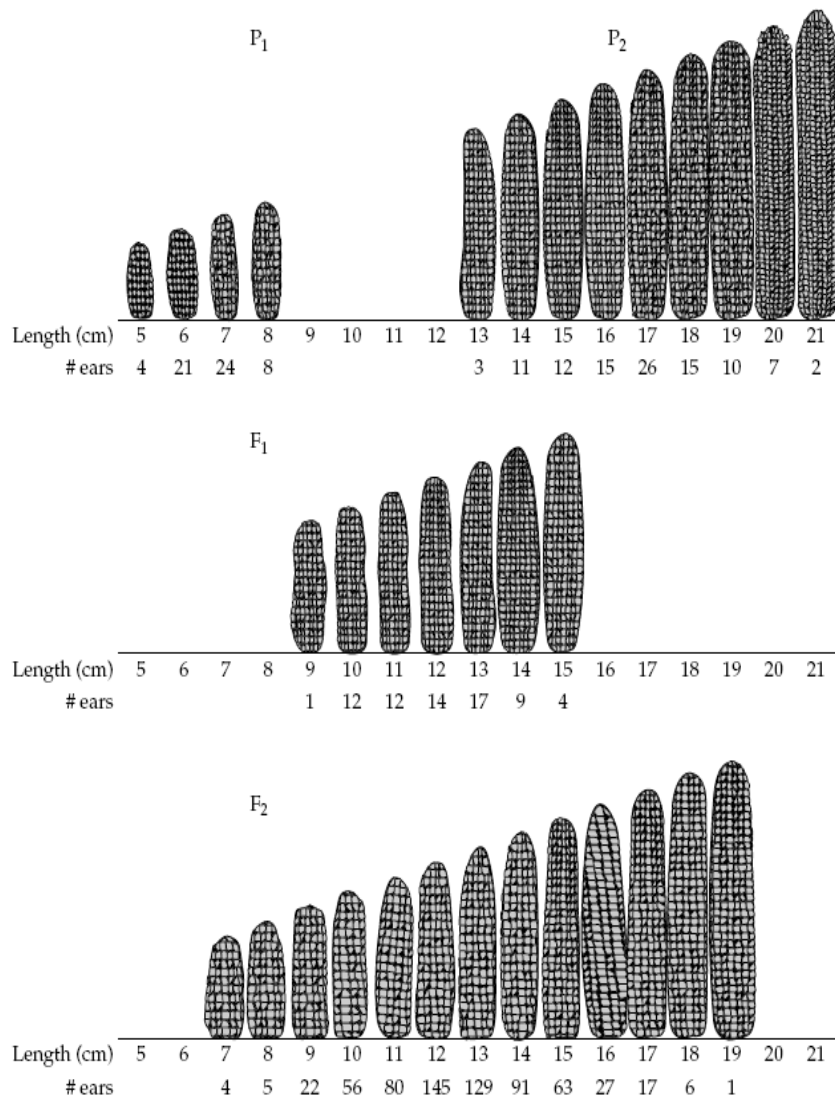

**QUANTITATIVE TRAITS - QUALITATIVE TRAITS AND DIFFERENCES BETWEEN THEM****Quantitative genetics (Inheritance of Multiple Genes)**

The phenotypic traits of the different organisms may be of two kinds, viz., qualitative and quantitative. The qualitative traits are the classical Mendelian traits of kinds such as form (e.g., round or wrinkle seeds of pea); structure (e.g., horned or hornless condition in cattles); pigments (e.g., black or white coat of guinea pigs); and antigens and antibodies (e.g., blood group types of man) and so on. We have already discussed in previous chapters that each qualitative trait may be under genetic control of two or many alleles of a single gene with little or no environmental modifications to obscure the gene effects. The organisms possessing qualitative traits have distinct (separate) phenotypic classes and are said to exhibit discontinuous variations.

The quantitative traits, however, are economically important measurable phenotypic traits of degree such as height, weight, skin pigmentation, susceptibility to pathological diseases or intelligence in man; amount of flowers, fruits, seeds, milk, meat or egg produced by plants or animals, etc. The quantitative traits are also called metric traits. They do not show clear cut differences between individuals and forms a spectrum of phenotypes which blend imperceptively from one type to another to cause continuous variations. In contrast to qualitative traits, the quantitative traits may be modified variously by the environmental conditions and are usually governed by many factors or genes (perhaps 10 or 100 or more), each contributing such a small amount of phenotype that their individual effects cannot be detected by Mendelian methods but by only statistical methods.

Such genes which are non-allelic and effect the phenotype of a single quantitative trait, are called polygenes or cumulative genes. The inheritance of poly genes or quantitative traits is called quantitative inheritance, multiple factor inheritance, multiple gene inheritance or polygenic inheritance. The genetical studies of qualitative traits are called qualitative genetics.

**Certain Characteristics of Quantitative Inheritance**

The quantitative inheritance have following characteristics:

1. The segregation phenomenon occurs at an indefinitely large number of gene loci.
2. If a substitution of a allele occurs in a gene locus then such allelic substitutions have trivial effects.
3. The genes for a multiple trait have different biochemical functions but similar phenotypic effects, therefore, the phenotypic effects of gene substitutions are interchangeable.

4. Blocks of genes are bound together by inversions and transmitted as units from inversion heterozygotes to their progeny, but such blocks are broken up by crossing over in inversion homozygotes.
5. The polygenes have pleiotropic effects; that is, one gene may modify or suppress more than one phenotypic trait. A single allele may do only one thing chemically but may ultimately affect many characters.
6. The environmental conditions have considerable effect on the phenotypic expression of poly genes for the quantitative traits. For example, height in many plants (e.g., corn, tomato, pea, marigold) is genetically controlled quantitative trait, but some environmental factors such as soil, fertility, texture, and water, the temperature, the duration and wavelength of incident light, the occurrence of parasites, etc., also affect the height. Similarly, identical twins with identical genotypes, if grown up in different kinds of environments, show different intelligence quotients.

### Examples of Quantitative Inheritance

#### 1. Kernel Colour in Wheat

Nilsson-Ehle (1909) and East (1910, 1916) gave the first significant clue of quantitative inheritance by their individual works on wheat. They crossed a strain of red kernel wheat plant with another strain of white kernel. Grain from the  $F_1$  was uniformly red, but of a shade intermediate between the red and white of the parental generation. This might suggest incomplete dominance, but when  $F_1$  offsprings were crossed among themselves, the  $F_2$  zygotes showed five different phenotypic classes in a ratio of 1 : 4 : 6 : 4 : 1

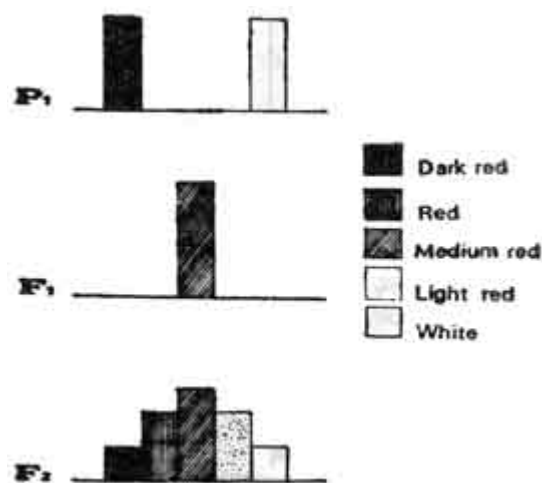

Noting that 1/16 of the  $F_2$  was an extreme in colour as either of the parental plants (red or white), they theorized that two pairs of genes controlling production of red pigment

## Principles of Genetics

while operating in this cross. Each gene was supposed to contain two alleles. One allele produces a given quantity of the red pigment, while its counterpart did not produced any pigment. All alleles were equally potent in the production or lack of production of pigment. If we symbolize the genes for red with the capital letters A and B and their, alleles resulting in lack of pigment production by a and b: We can illustrate the results of this cross as follows:or  
1/16 Red: 4/16 Dark: 6/16 Medium: 4/16 Light: 1/16 White.

<b>P:</b>	<b>Red</b>		<b>White</b>
	<b>AABB</b>	<b>x</b>	<b>aabb</b>
<b>Gametes:</b>	<b>(AB)(AB)</b>		<b>(ab)(ab)</b>
<b>F<sub>1</sub>:</b>	<b>Medium</b>		<b>Medium</b>
	<b>AaBb</b>	<b>x</b>	<b>AaBb</b>

2.. Noting that 1/16 of the F<sub>2</sub> was an extreme in colour as either of the parental plants (red or white), they theorized that two pairs of genes controlling production of red pigment while operating in this cross. Each gene was supposed to contain two alleles. One allele produces a given quantity of the red pigment, while its counterpart did not produced any pigment. All alleles were equally potent in the production or lack of production of pigment. If we symbolize the genes for red with the capital letters A and B and their, alleles resulting in lack of pigment production by a and b: We can illustrate the results of this cross as follows:or  
1/16 Red: 4/16 Dark: 6/16 Medium: 4/16 Light: 1/16 White.

<b>P:</b>	<b>Red</b>		<b>White</b>
	<b>AABB</b>	<b>x</b>	<b>aabb</b>
<b>Gametes:</b>	<b>(AB)(AB)</b>		<b>(ab)(ab)</b>
<b>F<sub>1</sub>:</b>	<b>Medium</b>		<b>Medium</b>
	<b>AaBb</b>	<b>x</b>	<b>AaBb</b>

♂	AB	Ab	aB	ab
♀	AB	AABb Red	AaBB Dark	AaBb Medium
	Ab	AABb Dark	AaBb Medium	Aabb Light
	aB	AaBB Dark	aaBB Medium	aaBb Light

Ab	AaBb Medium	Aabb Light	aaBb Light	Aabb White
----	----------------	---------------	---------------	---------------

### 3. Skin Colour in Man

Another classical example of polygenic inheritance was given by Davenport (1913) in Jamaica. He found that two pairs of genes, A-a and B-b cause the difference in skin pigmentation between Negro and Caucasian people. These genes were found to affect the character in additive fashion. Thus, a true Negro has four dominant genes, AABB, and a white has four recessive genes aabb. The F<sub>1</sub> offspring of mating of aabb with AABB, are all AaBb and have an intermediate skin colour termed mulatto. A mating of two such mulattoes produces a wide variety of skin colour in the offspring, ranging from skins as dark as the original Negro parent to as white as the original white parent. The results of this cross are as follows :

<b>Parents:</b>	Negro		White
	AABB	x	aabb
<b>Gametes:</b>		↓	
<b>F<sub>1</sub>:</b>	Mulatto		Mulatto
	AaBb	x	AaBb
		↓	

#### F<sub>2</sub> results:

Phenotypes	Genotypes	Genotypic Frequency	Phenotypic Ratio
Black (Negro)	AABB	1	1
Dark	AaBB,	2	4
	AA Bb	2	
Intermediate	AaBb	4	6
	aaBB	1	
	AA bb	1	
Light	Aabb	2	4
	Aa Bb	2	
White	aa bb	1	1

These results are clearly showing that A and B genes produce about the same amount of darkening of the skin ; and therefore, the increase or decrease of A and B genes cause variable phenotypes in F<sub>2</sub> in the ratio of 1 Negro: 4 dark : 6 intermediate: 4 light : 1 white.

#### 4. Height in Man

Skin colour in man is a rather simple example of polygenic inheritance because only two pairs of genes are involved. The inheritance of height in man is a more complex phenomenon involving perhaps ten or more pairs of genes. The character of tallness is recessive to shortness, thus, an individual having the genotype of more dominant genes will have the phenotype of shortness. Because, this quantitative trait is controlled by multiple pairs of genes and is variously influenced by a variety of environmental conditions. The heights of adults range from 140 cm to 203 cm.

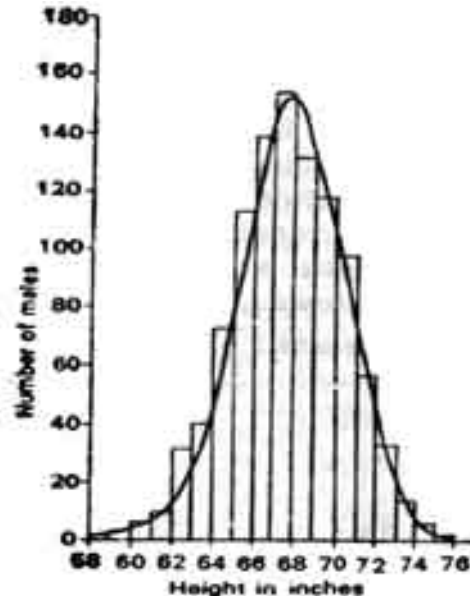

If one measured the height of a thousand adult men and the height of each is plotted against height in centimeters and the points connected, a bell-shaped curve is produced which is called curve of normal distribution and is characteristic of quantitative inheritance.

#### 6. Other Examples

Likewise, if one measures the length of thousand sea shells the same species, or counts the number of kernels per ear in a thousand ears of corn, or the number of pigs per litter in a thousand litters, or weighs one thousand hen's egg, one will find a normal curve of distribution in each case.



**Qualitative characters**

The easiest characters, or traits, to deal with are those involving discontinuous, or qualitative, differences that are governed by one or a few major genes. Many such inherited differences exist, and they frequently have profound effects on plant value and utilization. Examples are starchy versus sugary kernels (characteristic of field and sweet corn, respectively) and determinant versus indeterminate habit of growth in green beans (determinant varieties are adapted to mechanical harvesting). Such differences can be seen easily and evaluated quickly, and the expression of the traits remains the same regardless of the environment in which the plant grows. Traits of this type are termed highly heritable.

**A qualitative trait** is expressed qualitatively, which means that the phenotype falls into different categories. These categories do not necessarily have a certain order. The pattern of inheritance for a qualitative trait is typically monogenetic, which means that the trait is only influenced by a single gene. Inherited diseases caused by single mutations are good examples of qualitative traits. Another is blood type. The environment has very little influence on the phenotype of these traits.

The major differences between the two are following:

<b>Qualitative genetics</b>	<b>Quantitative genetics</b>
It deals with the inheritance of traits of kind, viz., form, structure, colour, etc.	It deals with the inheritance of traits of degree, viz., heights of length, weight, number, etc.
Discrete phenotypic classes occur which display discontinuous variations	A spectrum of phenotypic classes occur which contain continuous variations.
Each qualitative trait is governed by two or many alleles of a single gene.	Each quantitative trait is governed by many non-allelic genes or polygenes.
The phenotypic expression of a gene is not influenced by environment.	Environmental conditions effect the phenotypic expression of polygenes variously.
It concerns with individual matings and their progeny.	It concerns with a population of organisms consisting of all possible kinds of matings.
In it analysis is made by counts and ratios.	In it analysis is made by statistical method

# Quantitative and qualitative traits

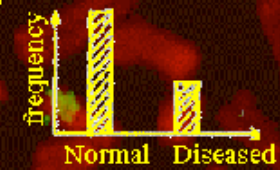
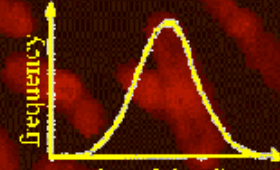
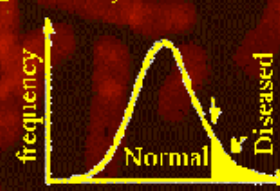
Trait	Mode of inheritance	Environmental effects	Diseases
<b>Qualitative,</b> Blood and serum types Enzyme defects	Simple Mendelian (monogene)	Little	 <p>frequency</p> <p>Normal Diseased</p>
<b>Quantitative,</b> Stature height Intelligence Milk yield	Complex (polygene)	Moderate to great	 <p>frequency</p> <p>Severity of the disease</p>
<b>Threshold.</b> Hare lip Pyloro stenosis Many diseases	Complex (polygene)	Moderate to great	 <p>frequency</p> <p>Normal Diseased</p> <p>Number of disease factors</p>

**CYTOPLASMIC INHERITANCE**

Inheritance of most of the characters in eukaryotic organisms shows the following characteristic features.

1. The contributions by both male and female parents are equal so that the results from reciprocal crosses are identical.
2. Segregation produces the characteristic 3:1 ratio in the F<sub>2</sub> generation of a monohybrid cross and a typical 9:3:3:1 in dihybrid crosses.

These features of inheritance were first demonstrated by Mendel: consequently, such an inheritance pattern is referred to as Mendelian inheritance. It is universally accepted that genes showing Mendelian inheritance are located in the chromosomes of eukaryotic nuclei. Therefore Mendelian inheritance pattern is regarded as a sufficient evidence for a gene to be located in the chromosomes, such genes are termed as nuclear genes or more commonly simply as genes.

**Non Mendelian Inheritance**

But some characters in several organisms do not show Mendelian inheritance or they show a non Mendelian inheritance pattern. In such cases, the following characteristic features are observed.

1. There is consistent difference between the results from reciprocal crosses; generally only the trait from female parent is transmitted.
2. In most cases, there is no segregation in the F<sub>2</sub> and subsequent generations.

Characters showing non Mendelian inheritance may be grouped under three broad categories:

- (1) those related to cellular structures and patterns,
- (2) those produced by intracellular parasites, symbionts and viruses
- (3) those associated with DNA containing cell organelles viz., mitochondria and chloroplasts.

In addition to these cases of non Mendelian inheritance, some characters in several organisms exhibit a Mendelian inheritance pattern but the development of these characters in an individual is markedly affected by the genotype of the maternal parent of the concerned individual; such cases are classified as maternal effects.

The evidence for cytoplasmic inheritance was first presented by Correns in *Mirabilis jalapa* and by Baur in *Pelargonium zonale* in 1908. In case of cytoplasmic inheritance generally the character of only one of the two parents ( usually the female parent) is transmitted to the

progeny. As a result, reciprocal crosses exhibit consistent differences for such characters and there is a lack of segregation in the F<sub>2</sub> and the subsequent generations. Such inheritance is also referred to as extra nuclear inheritance, extrachromosomal inheritance and maternal inheritance.

Genes governing the traits showing cytoplasmic inheritance are located outside the nucleus and in the cytoplasm; hence they are referred to as plasma genes, cytoplasmic genes, cytogenes, extranuclear genes or extra chromosomal genes.

The sum total of all the genes present in the cytoplasm of a cell is known as Plasmon, while all the genes present in a plastid constitute a plastron.

### **Characteristics of cytoplasmic inheritance:**

- 1. Reciprocal differences:** Reciprocal crosses show marked differences for the characters governed by plasmagenes. In most cases, plasmagenes from only one parent, generally the female parent are transmitted, this phenomenon is known as uniparental inheritance.
- 2. Lack of segregation:** In general, F<sub>2</sub> F<sub>3</sub> and the subsequent generations do not show segregation for a cytoplasmically inherited trait. This is because the F<sub>1</sub> individuals generally receive plasma genes from one parent only.
- 3. Irregular segregation in biparental inheritance:** In some cases, plasma genes from both the parents are transmitted to the progeny, this is known as biparental inheritance.
- 4. Somatic segregation:** Plasma genes generally show somatic segregation during mitosis, a feature of rare occurrence in the case of nuclear genes.
- 5. Association with organelle DNA:** Several plasma genes have been shown to be associated with cp-DNA or mt-DNA.
- 6. Nuclear transplantation:** If nuclear transplantation reveals a trait to be governed by the genotype of cytoplasm and not by that of nucleus, cytoplasmic inheritance of the trait is strongly indicated. In nuclear transplantation, nucleus of a cell is removed and replaced by a nucleus of another genotype from a different cell. Generally nuclei of somatic cells are transplanted into zygotes before the first mitotic division is initiated.
- 7. Transfer of nuclear genome through back crosses:** The nucleus of a variety or species may be transferred into the cytoplasm of another species or variety through repeated back crossing with the former, which is used as the recurrent male parent. Lines produced in this way are known as alloplasmic lines since they have nuclei and cytoplasms from two different species. A comparison of the various characters of alloplasmic lines with those of the corresponding euplasmic line (lines having nuclei and cytoplasms from the same species) demonstrates cytoplasmic effects, if any on these traits. This technique is time consuming, but

extremely powerful; it has been extensively used to study the cytoplasmic differentiation during evolution.

**8. Mutagenesis:** Some mutagens eg: Ethidium bromide are highly specific mutagens for plasma genes while nuclear genes are not affected by them. Induction of mutation by such agents in a gene indicates it to be a plasma gene.

**9. Lack of chromosomal location:** In many organisms, extensive linkage maps of nuclear genes are available. If a gene is shown to be located in one of these linkage groups, it cannot be a plasma gene. Failure to demonstrate the location of a gene in one of the linkage groups of an organism is indicative of its cytoplasmic location, but this is highly tentative.

**10. Lack of association with a parasite, symbiont or virus:** In many cases, a cytoplasmically inherited character is associated with a parasite, symbiont or virus present in the cytoplasm of the organism. Such cases cannot be regarded as cases of cytoplasmic inheritance. Only those cytoplasmically inherited characters which are not associated with parasites, symbionts or viruses can be regarded as governed by plasma genes.

The known cases of true cytoplasmic inheritance are concerned with either chloroplast or mitochondrial traits and are usually associated with their DNA. Such cases are therefore often referred to as organellar inheritance, plastid inheritance and mitochondrial inheritance.

**Plastid inheritance:**

The inheritance pattern of plastid characters due to plasma genes located in plastid is known as plastid inheritance. Plastid inheritance was first case of cytoplasmic inheritance to be discovered independently by Correns and Baur in 1908. Variegation refers to the presence of white or yellow spots of variable size on the green background of leaves. Variegation may be produced by some environmental factors, some nuclear genes and in some cases, plasma genes.

**Inheritance of plastids in *Mirabilis jalapa*:**

The inheritance of plastids in Four 'O' clock plant *Mirabilis jalapa* was first described by Correns (1908). In *M. Jalapa*, some of the branches may have normal green leaves, while in the same plant, some other branches may have only pale green or white leaves and still others may have variegated leaves. Flowers on branches with normal green leaves produce seeds that grow into plants with normal green leaves irrespective of whether they are pollinated by pollen from branches with normal green variegated or pale green leaves.

**Progeny of a variegated four 'O' clock plant**

Type of branch from which flowers are chosen for	Type of branch from which pollen was obtained	Type of leaf in the progeny grown from seed
--	---	---

pollination		
Green	Green, variegated, pale green	Only green “ “
Variegated Green	Green Variegated Pale green	Green, variegated, or pale “ “
Pale green	Green Variegated Pale green	Green, pale green “ “

It is clear that variegation is determined by agencies transmitted through the female and that it is not influenced by the type of pollen used. These agencies are the chloroplast. They are capable of self-duplication and are transmitted from generation to generation through the cytoplasm of the egg. Seeds borne on a green branch have three gene only green plastids, seeds borne on a pale green branch have three gene only pale green plastids and seeds borne on a variegated branch have green or pale green or a mixture of the two types of plastids.

Variegation is thus a heredity character determined by stable, self-duplicating, extra nuclear particles called plastids. Neither the nucleus of the female gamete nor the male gamete is involved in the control of this type of heredity character.

**Maternal inheritance by ‘iojap’ gene in maize**

The egg regularly contributes much more cytoplasm to the next generation than does the sperm. It should therefore be expected that in cases of cytoplasmic inheritance, differences between reciprocal crosses would result.

Rhoades (1946) identified the ‘iojap’ gene (ijj) in maize located in chromosome VII controlling plastid inheritance in the plant. The gene ‘lj’ is responsible for the normal green colour of the plant.

When normal green plants with ljlj are used as female and pollinated by pollen from stripped with ijj, F1 plants are wholly green.

1. Green x stripped

lj lj ij ij  
F1 Green

F2 3 green : 1 lojap.

When striped with ijij are pollinated by pollen from the normal green plants with ljlj the F1 plants, all of which have the same genotype. Ijij are of 3 different phenotypes.

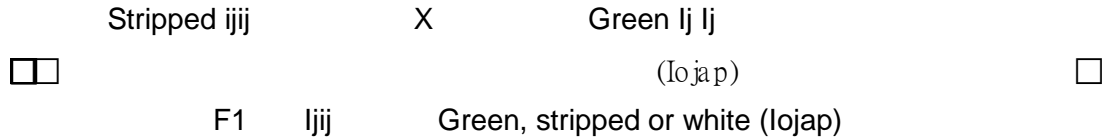

When plants with same genotype Ijij have different phenotype viz., normal green, stripped or white, the differences can be attributed only the differences in plastids.

**Cytoplasmic male sterility in Maize**

In case of male sterility in maize, pollen grains of such male sterile are aborted. This male sterility is transmitted only through the female and never by the pollen. When all of the chromosomes of the male sterile line were replaced with chromosomes of normal plants, the line still remained male sterile, showing thereby that male sterility is controlled by some agency in the cytoplasm. It was later recognized that cytoplasmic male sterility in maize results from alterations in the heredity units in the mitochondria (mitochondrial DNA).

**Inheritance of Kappa particles in Paramecium**

In *Paramecium aurelia*, two strains of individuals have been reported. One is called as 'Killer' which secretes a toxic substance 'paramecin' and the other strain is known as 'sensitive' and is killed if comes in contact with the 'paramecin'. In the cytoplasm of the killer strain the kappa particles (cytoplasmic - DNA) are present kappa particles are absent in sensitive strains. The transmission of kappa particles is through cytoplasm but maintenance of kappa particles and production of paramecin is controlled by 'k' we assume that the killer strains carry dominant allele 'kk; and that sensitive 'kk'. Conjugation Rare conjugation (cytoplasmic exchange)

On conjugation, conjugants exchange their nuclear material so that ex-conjugants 'kk' resulted from conjugants 'kk' and 'kk' when conjugation is for normal time, then only nuclear material is exchanged and therefore killer will produce killer daughters and sensitive will produce sensitive daughters. But if the conjugation is in longer period, there will be exchange of cytoplasm resulting in the inheritance of kappa particles by both the ex-conjugants so that all the daughter paramecia produced are killers because all inherit the kappa particles through the

mixing of cytoplasm. Therefore this trait is transmitted through cytoplasmic heredity. The trait is only stable in killer strains.

### **Inheritance through mitochondria**

Mitochondria can self-replicate and represent another genetic system in the cell. Of course, the amount of mitochondrial DNA is so small, representing less than 1% of the nuclear DNA in mammalian cells and it can code for a part of the protein in the mitochondria. The synthesis of the cytochrome found in mitochondria for example, is known to be present in minute amount in cytoplasm under the control of nuclear genes. Therefore, it is suggested that both mitochondria and chloroplast seem to have a semiautonomous existence and their DNA forms the basis for genetic systems separate from that in the nucleus.

### **Episome in Bacteria**

Some hereditary particles have been found to exist in two states, either in an autonomous state in the cytoplasm, where they replicate independently, of the chromosomes, or in an integrated state incorporated into the chromosome. Particles with such properties are known as episomes and include such things as the sex factor. The episomes are apparently not essential to the life of the bacteria, because they may or may not be present. If they are absent, they can be acquired only from an external source. In bacteria, *E. coli*, sex is determined by the presence or absence of the sex factor (F). Male bacterial cells (donor) have the sex factor and this factor is responsible for the transfer of DNA from male to female bacterial cells (Recipient). This sex factor is the cytoplasmic particle.

### **Significance of Cytoplasmic Inheritance**

1. Development of cytoplasmic male sterility several crop plants like maize, Pearl millet, sorghum, cotton etc.
2. Role of mitochondria in the manifestation of heterosis.
3. Mutation of chloroplast DNA and mitochondrial DNA leads to generation of new variation



## Methods of inducing mutations and C / B technique

### Mutagens

Mutations can be induced by a number of agents; the agents capable of inducing mutations are called mutagens. Mutagen is a natural or human-made agent (physical or chemical) which can alter the structure or sequence of DNA. The different mutagenic agents may be classified into the following two broad groups:

- 1) Physical mutagens
- 2) Chemical mutagens

### Physical mutagens

The different types of radiations having mutagenic properties are known as physical mutagens. The radiations may be a part of the electromagnetic spectrum having shorter wavelength and higher energy than visible light (eg: uv rays, X rays, gamma rays and cosmic rays) or may be particulate radiations produced by the decay of radio isotopes.

### Radiations

Radiation was the first mutagenic agent known; its effects on genes were first reported in the 1920's. Radiation itself was discovered in 1890's: Roentgen discovered X-rays in 1895, Becquerel discovered radioactivity in 1896, and Marie and Pierre Curie discovered radioactive elements in 1898. These three discoveries and others led to the birth of atomic physics and our understanding of electromagnetic radiation.

Radiations are grouped into two classes depending on the kind of effects they have on the atoms in their path:

1. ionizing and
2. non – ionizing radiations

### Non – ionizing radiations

Ultraviolet rays are the only non ionizing radiation with mutagenic properties. The wave length ranges from 100 – 3900 Å. And they are specifically absorbed by purines and pyrimidines present in DNA. The maximum absorption of UV rays by DNA as well as by pyrimidines, particularly thymine occurs at the wavelength of 254 nm, which is also the most mutagenic wavelength of UV.

The mutagenic action of uv is the consequence of both its direct and indirect effects on DNA. The direct effect of uv on DNA is of two types: formation of (1) pyrimidine dimmers and pyrimidine hydrates.

### **Ionizing radiations**

Ionizing radiations are so called because they cause ionization in the atoms present in their path. There are two types of ionizing radiations: (1) particulate and (2) non particulate radiations. Particulate radiations consist of high energy atomin particles generated due to radioactive decay. The non particulate ionizing radiations are represented by X rays and gamma rays which are high energy radiations composed of photons.

The genetic effects of radiations may be (1) direct or (2) indirect. The direct effect of radiations is produced due to ionizations directly in the DNA molecule, while their indirect effect is produced through ionizations ini molecules other than DNA and is believed to be mediated by free radical formation.

### **Sources of radiation**

Natural sources of radiation produce so-called background radiation. These include cosmic rays from the sun and outer space, radioactive elements in soil and terrestrial products (wood, stone) and in the atmosphere (radon). One's exposure due to background radiation varies with geographic location.

In addition, humans have created artificial sources of radiation which contribute to our radiation exposure. Among these are medical testing (diagnostic X-rays and other procedures), nuclear testing and power plants, and various other products (TV's, smoke detectors, airport X-rays).

### **Chemical mutagens**

The first report of mutagenic action of a chemical was in 1942 by Charlotte Auerbach, who showed that nitrogen mustard (component of poisonous mustard gas used in World Wars I and II) could cause mutations in cells. Since that time, many other mutagenic chemicals have been identified and there is a huge industry and government bureaucracy dedicated to finding them in food additives, industrial wastes, etc. It is possible to distinguish chemical mutagens by their modes of action; some of these cause mutations by mechanisms similar to those which arise spontaneously while others are more like radiation in their effects.

### 1. Base analogs

These chemicals structurally resemble purines and pyrimidines and may be incorporated into DNA in place of the normal bases during DNA replication:

- **bromouracil (BU)**--artificially created compound extensively used in research. Resembles thymine because it has Br in the 5 position instead of methyl group and has the same effect on its base pairing behavior as that of -CH<sub>3</sub> in the same position and therefore 5 BU behaves like thymine and usually pairs with adenine.
- **aminopurine** --adenine analog which can pair with T or (less well) with C; causes A:T to G:C or G:C to A:T transitions. Base analogs cause transitions, as do spontaneous tautomerization events.

### 2. Chemicals which alter structure and pairing properties of bases

There are many such mutagens; some well-known examples are:

- **nitrous acid**--formed by digestion of nitrites (preservatives) in foods. It causes C to U, mC to T, and A to hypoxanthine deaminations. Hypoxanthine in DNA pairs with C and causes transitions. Deamination by nitrous acid, like spontaneous deamination, causes transitions.
- **nitrosoguanidine, methyl methanesulfonate, ethyl methanesulfonate**-chemical mutagens that react with bases and add methyl or ethyl groups. Depending on the affected atom, the alkylated base may then degrade to yield a baseless site, which is mutagenic and recombinogenic, or mispair to result in mutations upon DNA replication.

### 3. Intercalating agents

**Acridine orange, proflavin, ethidium bromide** (used in labs as dyes and mutagens). All are flat, multiple ring molecules which interact with bases of DNA and insert between them. This insertion causes a "stretching" of the DNA duplex and the DNA polymerase is "fooled" into inserting an extra base opposite an intercalated molecule. The result is that intercalating agents cause frameshifts.

### 4. Agents altering DNA structure

This is used as a "catch-all" category which includes a variety of different kinds of agents. These may be:

- --large molecules which bind to bases in DNA and cause them to be noncoding--we refer to these as "bulky" lesions (eg. **NAAAF**)
- --agents causing intra- and inter-strand crosslinks (eg. **psoralens**--found in some vegetables and used in treatments of some skin conditions)
- --chemicals causing DNA strand breaks (eg. **peroxides**)

What these agents have in common is that they probably cause mutations not directly but by induction of mutagenic repair processes.

### Detection of mutation

The occurrence of mutational event at the gene level is detected by the alteration it brings about in the phenotypic expression of one or more traits of the concerned organism. Therefore the efficiency of detection of mutations will depend largely on the availability of techniques for an easy and rapid scoring of the mutant phenotypes in very large populations. Scoring of some types of mutations in certain organisms is relatively easy. For example, mutations for antibiotic resistance in bacteria are simply detected by plating the bacterial cells on a medium containing a lethal concentration of the concerned antibiotic (selective medium); the colonies that develop on such a medium will be produced by cells resistant to the antibiotic. The medium lacking the antibiotic is called the non selective medium.

$$\text{Frequency of mutant cells (\%)} = \frac{\text{Number of colonies on the selective medium}}{\text{Number of colonies on the non selective medium}} \times 100$$

Detection of morphological mutations in eukaryotes requires examination of each individual of the population for the mutant phenotype; this is not only tedious requiring time, but is also a source of errors in the data. Therefore, elaborate procedures for mutation detection have been developed in some eukaryotes . eg; *Drosophila*, maize etc. These procedures employ specific markers to facilitate the identification of chromosomes from the treated or irradiated individuals. Clearly these techniques detect only germinal mutations. In *drosophila*, several specila genetic stocks have been constructed for the detection of lethal and visible mutations in X chromosomes and in autosomes; the two genetic stocks most commonly used for mutation detection in X chromosome are (1) CIB and (2) Attached X stocks.

### **C/B Technique**

This method was invented by Muller and used for the unequivocal demonstration of mutagenic action of X rays. In this method, females containing one normal X-chromosome and another X-chromosome (C/B) containing extra 3 genes are used for the analysis. Out of the 3 extra genes, one gene suppresses crossover (c), the other is a recessive lethal (L) in heterozygous condition, and the last gene is semidominant marker, Bar (B) gene.

Females containing C/B chromosome are called as C/B stock drosophila. The normal males are exposed to mutagenic source for a fixed period and then mated to the C/B stock drosophila. Males containing C/B chromosome will die due to the effect of lethal genes, whereas normal males and females both normal and with C/B will survive.

Females with C/B chromosomes and identified by barred phenotype are selected and crossed to normal males. In this next generation 50% of males (which have received the C/B gene) will die.

If mutation has occurred in normal X chromosome then even the normal male (without C/B gene) will die. If no mutation has occurred all the other 50% of males will survive. The frequency of lethal mutations can be accurately scored in large samples. This technique is simple, rapid and there is little chance of an error in scoring. However, it is suitable for the scoring of sex linked recessive lethal only.

### **The attached X chromosome technique**

This technique is based on attached – X females (X- XY) and is designed to study visible sex linked mutations in Drosophila. Mutagen treated males are mated with attached X females. The X- XX (super female) and YY progeny produced from such crosses do not survive; only X- XY (female) and XY (male) progeny are recovered. All male (XY) progeny receive their Y chromosomes from their attached X female parent, while their X chromosomes is contributed by their mutagen treated male parent. If a visible mutation was induced in the X chromosomes of any sperm produced by the mutagen treated male, it will be expressed in the male progeny. Therefore all the male progeny obtained from the cross are scored for visible mutations. The frequency of a visible mutation is expressed as the ratio

between the number of progeny males showing a mutation and the total number of males in the progeny.

### **Detection of mutations in plants**

Techniques for the detection of mutations are relatively poorly developed for plant species. The following two approaches are generally adopted for this purpose.

(1) In some species, eg; maize, strains homozygous for several recessive genes as well as for dominant alleles of these genes are available. In such cases seeds or plants of a strain homozygous for several dominant genes are treated with a mutagen. The plants (M1 generation) are crossed with a strain having the recessive forms of the traits governed by the concerned genes are counted and the frequency of mutation for a gene is estimated as follows:

$$\text{Mutation frequency (\%)} \text{ for a gene} = \frac{\text{Number of plants having the recessive form of trait governed by the gene}}{\text{Total number of plants in the progeny}} \times 100$$

The plants showing the recessive form of such a trait will receive one recessive allele from the tester parent with the recessive traits, while the other recessive allele would have been produced due to mutation in the mutagen treated parent.

## MUTATIONS

### Introduction

Nature's intention is that the exact genetic information from both parents will be seen in the offspring's DNA in the critical stages of fertilization. However, it is possible for this genetic information to mutate, which in most cases, can result in fatal or negative consequences in the outcome of the new organism.

### Non-Disjunction and Down's Syndrome

One well known example of mutation is non-disjunction. Non-disjunction is when the spindle fibres fail to separate during meiosis, resulting in gametes with one extra chromosome and other gametes lacking a chromosome. If this non-disjunction occurs in chromosome 21 of a human egg cell, a condition called Down's syndrome occurs. This is because their cells possess 47 chromosomes as opposed to the normal chromosome complement in humans of 46.

The fundamental structure of a chromosome is subject to mutation, which will most likely occur during crossing over at meiosis. There are a number of ways in which the chromosome structure can change, which will detrimentally change the genotype and phenotype of the organism. However, if the chromosome mutation affects an essential part of DNA, it is possible that the mutation will abort the offspring before it has the chance of being born.

### Mutation

In most organisms genes are segments of DNA molecules. In the broad sense, the term 'mutation' refers to all the heritable changes in the genome, excluding those resulting from incorporation of genetic material from other organisms. A mutation is an abrupt qualitative or quantitative change in the genetic material of an organism. Mutations may be intragenic or intergenic. Intragenic mutations or point mutations include alterations in

the structure of the DNA molecule within a gene. In a point mutation there is a change in the normal base sequence of the DNA molecule.

This change results in a modification of the structural characteristics or enzymatic capacities of the individual. The unit of gene mutation is the muton. This may consist of one or many nucleotide pairs. Intergenic mutations, of which chromosomal changes in structure are examples, involve long regions of DNA, i.e. many genes. These include deletion or addition of segments of chromosomes, resulting in deficiency and duplication, respectively. In large deletions a base sequence corresponding to an entire polypeptide chain is sometimes lost. Such mutations are very useful in genetic mapping.

### **Germinal and Somatic Mutations**

Eukaryotic organisms have two primary cell types - germ and somatic. Mutations can occur in either cell type. If a gene is altered in a germ cell, the mutation is termed a **germinal mutation**. Because germ cells give rise to gametes, some gametes will carry the mutation and it will be passed on to the next generation when the individual successfully mates. Typically germinal mutations are not expressed in the individual containing the mutation.

Somatic cells give rise to all non-germline tissues. Mutations in somatic cells are called **somatic mutations**. Because they do not occur in cells that give rise to gametes, the mutation is not passed along to the next generation by sexual means. To maintain this mutation, the individual containing the mutation must be cloned. Two examples of somatic clones are navel oranges and red delicious apples.

### **Spontaneous and Induced Mutations**

In general, the appearance of a new mutation is a rare event. Most mutations that were originally studied occurred spontaneously. This class of mutation is termed **spontaneous mutations**. But these mutations clearly



represent only a small number of all possible mutations. To genetically dissect a biological system further, new mutations were created by scientists by treating an organism with a mutagenizing agent. These mutations are called **induced mutations**.

The spontaneous mutation rate varies. Large gene provides a large target and tends to mutate more frequently. A study of the five coat color loci in mice showed that the rate of mutation ranged from  $2 \times 10^{-6}$  to  $40 \times 10^{-6}$  mutations per gamete per gene. Data from several studies on eukaryotic organisms shows that in general the spontaneous mutation rate is  $2-12 \times 10^{-6}$  mutations per gamete per gene.

Mutations can be induced by several methods. The three general approaches used to generate mutations are **radiation**, **chemical** and **transposon insertion**. The first induced mutations were created by treating *Drosophila* with X-rays. In addition to X-rays, other types of radiation treatments that have proven useful include gamma rays and fast neutron bombardment. These treatments can induce point mutations (changes in a single nucleotide) or deletions (loss of a chromosomal segment).

### **Other Types of mutations**

**Morphological mutants** affect the outward appearance of an individual. Plant height mutations could change a tall plant to a short one, or from having smooth to round seeds. **Biochemical mutations** have a lesion in one specific step of an enzymatic pathway. For bacteria, biochemical mutants need to be grown on a media supplemented with a specific nutrient. Such mutants are called **auxotrophs**. Often though, morphological mutants are the direct result of a mutation in a biochemical pathway. In humans, albinism is the result of a mutation in the pathway which converts the amino acid tyrosine to the skin pigment melanin. Similarly, cretinism results when the tyrosine to thyroxine pathway is mutated. For some mutations to be expressed, the individual needs to be

placed in a specific environment. This is called the **restrictive condition**. But if the individual grow in any other environment (**permissive condition**), the wild type phenotype is expressed. These are called conditional mutations. Mutations that only expressed at a specific temperature (temperature sensitive mutants), usually elevated, can be considered to be **conditional mutations**. **Lethal mutations** are also possible. As the term implies, the mutations lead to the death of the individual. Death does not have to occur immediately, it may take several months or even years. But if the expected longevity of an individual is significantly reduced, the mutation is considered a lethal mutation. If a mutation occurs in that allele, the function for which it encodes is also lost. The general term for these mutations is **loss-of-function mutations**. The degree to which the function is lost can vary. If the function is entirely lost, the mutation is called a **null mutation**. It is also possible that some function may remain, but not at the level of the wild type allele. These are called **leaky mutations**.

### Types of Mutations

I. Chromosome Mutations - gross changes in chromosomes.

#### Changes in the number of chromosomes.

1. **Euploidy** - variation in the number of sets of chromosomes.
  - a. **Haploidy (Monoploidy)** - one set of chromosomes ( $n$ ) : ABC
  - b. **Polyploidy**-three or more sets of chromosomes.
  - c. **Triploidy**-3 sets of chromosomes ( $3n$ ) : ABC, ABC, ABC.
  - d. **Tetraploidy**-4 sets of chromosomes ( $4n$ ): ABC, ABC, ABC, ABC.
  - e. **Pentaploidy**-5 sets of chromosomes ( $5n$ ) : ABC, ABC, ABC, ABC, ABC.
  - f. **Hexaploidy** ( $6n$ ), **Septaploidy** ( $7n$ ), **Octoploidy** ( $8n$ ), etc

**2. Aneuploidy** - variation in the number of chromosomes of a set.

(Reduction in the normal number of chromosomes. )

**a. Monosomics** - Loss of one chromosome ( $2n-1$ ) : ABC, AB.

**b. Double monosomics** - loss of 2 different chromosomes ( $2n-1-1$ ): ABC, A.

b - loss of a pair of homologous chromosomes ( $2n-2$ ) : AB, AB:

b. Increase in the number of chromosomes (polysomies).

**Trisomies** - presence of 1 extra chromosome ( $2n+ 1$ ) : ABC, ABC, A.

**Double trisomics** - 2 different extra chromosomes ( $2n + 1 + 1$ ) : ABC, ABC, AB.

**Tetrasomics** - an extra pair of homologous chromosomes ( $2n+2$ ): ABC, ABC, AA.

**pentasomics** ( $2n+3$ ), **Hexasomics** ( $2n+4$ ), **Sepiasomics** ( $2n+5$ ), etc.

## **B. Changes in the structure of chromosomes.**

a. Loss or addition of segments of chromosomes.

**Deletion (deficiency)** - loss of a segment of a chromosome

**Duplication** - repetition of a segment of a chromosome.

b. Changes in the normal arrangement of genes in the chromosome.

**Translocation** – Exchange of segments between two non - homologous chromosomes, resulting in new chromosomes.

**Inversion** – Change in the linear order of genes by rotation of a section of a chromosome through 180 degrees.

**C. Gene mutations or point mutations** – changes in the nucleotide sequence of a gene.

a. Deletion

b. Insertion

c. Substitution

### d. Inversion

#### **Rate of Mutation**

The frequency of spontaneous mutations is usually low, ranging from  $10^{-7}$  to  $10^{-12}$  per organism. The rate of detectable mutations in average gene is 1 in  $10^6$ . It should be noted, however, that most methods for estimating the rate of mutations tend to underestimate their frequency due to many reasons. Firstly, lethal mutations which leave no progeny may be missed. Secondly, mutations which leave only a slight change in the phenotype may remain undetected. Mutations occur much more frequently in certain regions of the gene than in others. The favoured regions are called 'hot spots'. Mutations involving single nucleotides can revert to normal gene structure. Most single nucleotide mutations are reversible. In many cases the rate of reverse mutations is similar to the rate of forward mutations. In rare locations the rate of forward mutation is much greater than the rate of backward mutation.

#### **Effects of Mutations on the Phenotype**

According to their effects on the phenotype mutations may be classified as lethals, sub vitals and super vitals. Lethal mutations result in the death of the cells or organisms in which they occur. Sub vital mutations reduce the chances of survival of the organism in which they are found. Super vital mutations on the other hand may result in the improvement of biological fitness under certain conditions. There may also be mutations which are neither harmful nor beneficial to the organism in which they occur.

#### **How Does a Mutation Act?**

As mentioned in other sections, genes act by controlling the rate of production of specific proteins (enzymes). The scheme of protein synthesis in most organisms is as follows:

(1) The DNA (gene) produces a complementary mRNA strand which has codons consisting of nucleotide triplets.

(2) tRNA molecules, each forming a complex with a specific amino acid, have three free nucleotides which form the anticodon.

(3) The alignment of tRNA molecules on mRNA depends upon complementary codon-anticodon pairing

(4) Thus the sequence of amino acid molecules in an enzyme (and hence the structure and functions of the enzyme) depends upon the nucleotide sequence of mRNA. This in turn depends upon the nucleotide sequence in DNA. It will be seen that any change in the sequence of nucleotides of DNA will result in a corresponding change in the nucleotide sequence of mRNA. This may result in alignment of different tRNA molecules on mRNA. Thus the amino acid sequence and hence the structure and properties of the enzyme formed, will be changed. This may affect the traits controlled by the enzyme.

### **Molecular Basis of Mutations**

Gene mutations at the molecular level involve modification of one base by another, or addition or deletion of one or more bases. Mutations may be spontaneous or induced **Spontaneous Mutations** - Mutations which occur under natural conditions are called spontaneous mutations. It should be noted that some spontaneous mutations arise by the action of mutagens present in the environment. These mutagens include cosmic radiation, radioactive compounds, heat, and such naturally occurring base analogues like caffeine. These will be considered under 'induced mutations' as they are external agents bringing about mutations. Truly spontaneous mutations that will be dealt with here are those arising from tautomerism.

### **Tautomerism**

The ability of a molecule to exist in more than one chemical form is called tautomerism. All the four common bases of DNA (adenine, guanine, cytosine and thymine) have unusual tautomeric forms, which are, however, rare. The normal bases of DNA are usually present in the keto form. As a result of tautomeric rearrangement they can be momentarily transformed

into the rare enol form in which the distribution of electrons is slightly different. Normal base pairing in DNA is A-T and G-C. The tautomeric forms are, however, capable of unusual ('forbidden') base pairing like T-G, G-T, C-A and A-C. This unusual base pairing results in misreplication of the DNA strand, giving rise to mutants in some of the progeny. Thus A\*, a rare tautomer of adenine (a) pairs with cytosine. This leads to G-C pairing in the next generation. Spontaneous mutations can also arise as a result of ambiguity of base pairing during replication because of 'wobble'

**Induced Mutations** A variety of agents increase the frequency of mutation. Such agents are called mutagens. They include chemical mutagens, and radiations like X-rays,  $\gamma$ -rays and UV-light.

**Chemical Mutagens** The first chemical mutagen discovered was mustard 'gas'. In the 1950s chemical mutagens with more or less specific action were developed. Chemical mutagens can be classified according to the way in which they bring about mutations:

- (1) Base analogues which are incorporated into DNA instead of normal bases
- (2) Agents modifying purines and pyridines and agents labilizing bases, and
- (3) agents producing distortions in DNA.

The agents in categories (1) and (3) require replication for their action, while agents in category (2) can modify even non replicating DNA.

Chemical mutagens work mostly by inducing **point mutations**. Two major classes of chemical mutagens are routinely used. These are **alkylating agents** and **base analogs**. Each has a specific effect on DNA. Alkylating agents [such as ethyl methane sulphonate (EMS), ethyl ethane sulphonate (EES) and mustard gas] can mutate both replicating and non-replicating DNA. By contrast, a base analog (5-bromouracil and 2-aminopurine) only mutate DNA when the analog is incorporated into replicating DNA. Each class of chemical mutagen has specific effects that can lead to transitions, transversions or deletions.

Scientists are now using the power of transposable elements to create new mutations. Transposable elements are mobile pieces of DNA that can move from one location in a genome to another. Often when they move to a new location, the result is a new mutant. The mutant arises because the presence of a piece of DNA in a wild type gene disrupts the normal function of that gene. As more and more is being learned about genes and genomes, it is becoming apparent that transposable elements are a power source for creating insertional mutants.

## REGULATION OF GENE EXPRESSION

Each cell of a living organism contains thousands of genes. But all genes do not function at a time. Genes function according to requirements of the cell. Genes control the phenotypic expression of various characters through the production of specific enzymes. Enzymes are special proteins which catalyse chemical reactions. The production or synthesis of a particular enzyme is not constant. It varies as per the requirement of the cell in other words, the synthesis of a particular enzyme is sometimes high and sometimes low depending upon the requirement of the cell. Thus, there exists an on-off system which regulates protein synthesis in all living cells. The precise study of this on-off mechanism is called regulation of gene action or regulation of gene expression or regulation of protein synthesis.

Synthesis of enzyme depends mainly on two factors. In a degradative process, the synthesis of enzyme depends on the availability of the molecule to be degraded. If the molecule is in more quantity, the enzyme synthesis will be more and vice versa. In a biosynthetic pathway, the synthesis of an enzyme is governed by the end product. If the end product is more, the enzyme synthesis will be less and vice versa. There are two types of gene regulation, viz, (1) negative regulation, and (2) positive regulation.

In negative regulation, this system and inhibitor is present in the cell, which prevents transcription by inactivating the promoter. This inhibitor is known as repressor. For initiation of transcription, an inducer is required. Inducer acts as antagonist of the repressor. In the negative regulation, absence of product increases the enzyme synthesis and presence of the product decreases the synthesis.

### Positive Control

In positive regulation, this system, an effector molecule (which may be a protein or a molecular complex) activates the promoter for transcription. In a degradative system, either negative or positive mechanism may operate. In a biosynthetic pathway negative mechanism usually operates.



### Important Terms

It is essential to define various terms which are commonly used in connection with regulation of gene expression. A brief description of important terms is presented below:

#### Brief description of important terms related to regulation of gene expression

Terms	Brief description
Repressor	In operon, protein molecules which prevents transcription. The process of inhibition of transcription is called repression.
Inducer	The substance which allows initiation of transcription (i.e., lactose in lac operon). Such process is known as induction.
Corepressor	A combination of repressor and metabolite which prevents protein synthesis. Such process is termed as corepression.
Inducible enzyme	An enzyme whose production is enhanced by adding the substrate in the culture medium. Such system is called inducible system.
Repressible enzyme	An enzyme whose production can be inhibited by adding an end product. Such system is known as repressible system.
Constitutive enzyme	An enzyme whose production is constant irrespective of metabolic state of the cell.
Negative control	Inhibition of transcription by repressor through inactivation of promoter e.g in lac operon.
Positive control	Enhancement of transcription by an effector molecule through activation of promoter.
Effector	The molecule which acts as an inducer or corepressor in the operon model of <i>E.coli</i>

### The Operon Model

The operon refers to a group of closely linked genes which act together and code for various enzymes of a particular biochemical pathway. In other words, operon is a model which explains about the one-off mechanism of protein synthesis

in a systematic manner. The operon model of gene regulation was proposed by Jacob and Monod in 1961. They were awarded Nobel prize for this discovery in 1965. The operon model was developed working with lactose region (lac region) of the human intestine bacteria *E.coli*. The gene regulation was studied for degradation of the sugar lactose. The operon model consists of seven main components, viz, (1) structural genes, (2) operator gene, (3) promoter gene, (4) regulator gene, (5) repressor, (6) corepressor, and (7) inducer. A brief description of these components is presented below:

### Structural Genes

The lac operon of *E.coli* consists of three structural genes, viz, z, y and a. The z gene is located near to the operator gene, y is located between z and a, and a is located on right end of the operon segment. These structural genes transcribe a single polycistronic mRNA molecule. This mRNA molecule controls the synthesis of three different enzymes, viz.,  $\beta$ - galacto-sidase, galactosidase permease and galactosidase transacetylase. The enzyme galactosidase consists of 4 units and catalyses the breakdown of lactose into glucose and galactose as given below:

The enzyme galactosidase permease is made up of one unit and permits entry of lactose from the medium into the bacterial cell. Galactosidase acetylase consists of two units. Its main function is to transfer an acetyl group from acetyl co-enzyme A to  $\beta$ - galactosidase. The function of all the structural genes is controlled by operator gene. Thus, the main function of structural genes is to control synthesis of protein through messenger RNA. In an operon, number of structural genes is always equal to the number of polypeptide chains synthesized under common control. If three types of proteins are synthesized from one operon, there should be three structural genes. In prokaryotes, all the structural genes form single polycistronic mRNA molecule, whereas in eukaryotes, each structural gene forms separate (monocistronic) mRNA molecule.

### Operator Gene

In lac operon of *E. coli*, the operator gene is located just near the structural gene z. It consists of 35 nucleotide base pairs. It is the binding site for the

repressor. The main function of operator gene is to control the function of structural genes. However, its own function depends on the repressor molecule. Binding of repressor with operator makes it non-functional and thus prevents transcription. Repressor prevents transcription by inactivating the promoter gene. Mutation of operator makes it unfit for binding with repressor. In such situations, operator is free from binding with repressor and transcription can start. When the repressor is bound to the operator, initiation of transcription of lac mRNA by RNA polymerase is prevented. When operator is free, the promoter is available for initiation of mRNA synthesis.

### **Promoter Gene**

In lac operon of **E. coli**, the promoter gene is located next to operator. This is located between operator gene and regulator gene. The promoter segment is a place where mRNA polymerase enzyme binds with DNA. The recent investigations (Pribnow, 19715) suggested that promoter segment has three sub regions, viz, (1) a recognition site, (2) a binding site, and (3) an m RNA initiation site. The main function of promoter gene is to initiate mRNA transcription. The m RNA transcription moves from promoter region to the structural genes through operator region. The promoter starts mRNA transcription only when operator is free or when repressor is not bound to the operator gene. The binding of repressor with operator inactivates the promoter gene and prevents transcription.

### **Regulator Gene**

The regulator gene is located on one end of operon segment in *E. coil*. The function of the regulator gene is to direct the synthesis of a repressor which is a protein molecule. The repressor may be either active or inactive (a prorepressor). Active repressor has a tendency to bind with operator gene in the inducible system. The repressor binds to the operator in the absence of an inducer and prevents mRNA transcription by inactivating the promoter gene. When an inducer (i.e., lactose) is present, the repressor binds to the inducer and forms an inducer – repressor complex. This complex cannot bind to operator gene and, therefore, protein synthesis can take place. In the repressible system, the repressor molecule is inactive and, therefore, cannot bind with the operator gene. In such condition,

protein synthesis by structural genes can take place. The repressor can become active on combining with co-repressor. This repressor corepressor complex blocks the operator gene and prevents protein synthesis.

### **Repressor**

Repressor is a protein molecule. Its synthesis is directed by regulator gene. It may be either in the active form or inactive form as described above. It has affinity with operator gene. In the active form, it binds with operator gene and prevents transcription and protein synthesis by inactivating promoter gene. When it is in inactive form, the transcription and protein synthesis can take place. This can be inactivated by an inducer.

### **Corepressor**

Corepressor is perhaps a product of one of the enzymes synthesized by structural genes. The corepressor makes the inactive repressor active in a repressible system after combining with the same. The repressor – corepressor complex can block the operator gene and stop protein synthesis by structural genes.

### **Inducer**

Inducer is a substrate (i.e. lactose in lac operon) which promotes transcription. It binds with repressor molecule and makes the same inactive. The repressor then cannot bind with operator gene. Hence, the transcription and protein synthesis can take place.

### **Mechanism of Gene Regulation**

The mechanism of gene regulation is of two types, viz, (1) negative regulation, (2) positive regulation. These are briefly described below:

#### **Negative Control**

In the negative regulation, absence of a product enhances the synthesis of enzyme and presence of the product decreases the synthesis of enzyme. In the lac operon of *E. coli*. The synthesis of protein depends whether the operator gene is blocked or free. When the operator gene is free, protein synthesis by structural

genes will take place. On the other hand, when the operator gene is blocked, the protein synthesis is prevented. Thus, the on-off of protein synthesis is governed by the free and occupied position of the operator gene. In negative control, regulator protein acts as an inhibitor and prevents protein synthesis. In lac operon of **E.coli**, there is negative control of gene regulation. In the negative control, the regulator protein is the repressor which inhibits protein synthesis. In the inducible system, the effector molecule is the inducer. The inducer binds with repressor and inactivates it so that it cannot bind with operator. Thus, inducer permits protein synthesis by inactivating the repressor. In the repressible system, the effector molecule is the corepressor. The corepressor on binding with in-active repressor makes it active and inhibits protein synthesis, because when repressor becomes active it will bind with operator and stop transcription.

### **Positive Control**

In positive regulation, presence of a product will enhance the synthesis of enzyme. In other words, in positive control the regulator protein acts as an activator and enhances the protein synthesis. The arabinose operon of **E.Coli** is an example of positive gene regulation.

### **Mutation of the Operon**

The mechanism of gene regulation is affected by the mutation of genes in the operon segment of *E. Coli*. The mutation of regulator gene will lead to production of inactive or non-functional repressor. Such repressor is unable to bind with promotor and, therefore, cannot inhibit transcription. In other words, defective repressor cannot control the function of operator gene. In such situations, there is constant synthesis of enzymes by the structural genes. This type of mutants is known as constitutive mutants and the enzymes which are produced as a result of constitutive mutations are referred to as constitutive enzymes.

Similarly, a mutation in the promotor region also alters the mechanism of gene regulation. It may lead to three different situations depending upon the type of mutation which takes place in the promotor gene.

## Principles of Genetics

1. Total inactivation of promotor gene, as a result of mutation, will prevent binding of RNA polymerase to the DNA at the promotor site.
2. An up-promotor mutation will permit rapid binding of RNA polymerase to the promotor site and lead to enhanced transcription and enzyme sythensis.
3. A down – promotor mutant will decrease the rate of RNA polymerase binding to promotor site and lead to reduction in enzyme synthesis.

Thus, mutation of genes in the operon especially of regulator and promotor genes alters the mechanism of gene regulation in a definite manner.

**LAC OPERON AND FINE STRUCTURE OF GENE**

The hereditary units which are transmitted from one generation to the next generation are called genes. A gene is the fundamental biological unit, like the atom which is the fundamental physical unit. Mendel while explaining the result of his monohybrid and dihybrid crosses, first of all conceived of the genes as particulate units and referred them by various names such as hereditary factors or hereditary elements. But his concept about the gene was entirely hypothetical and he remained ignorant about the physical and chemical nature of gene.

Even before the rediscovery of Mendel's laws in 1900, it was already established that chromosomes have a definite role in the inheritance because it was found that chromosomes were the only link between one generation and the next generation and a diploid chromosome set consists of two morphologically similar sets, one is derived from the mother and the other from the father at fertilization. Later on, a parallel behavior among chromosomes and genes was discovered.

Earlier workers proposed various hypotheses to explain the nature of genes. For instance, De Vries postulated one gene one character hypothesis according to which a particular trait of an individual is controlled by a particular gene. Bateson and Punnett proposed the presence or absence theory. According to them, in a cross the character which dominates the other has a determiner, while, the recessive character has no such determiner. But all the theories were discarded by Morgan, who produced the particulate gene theory in 1926. He considered genes as corpuscles, which are arranged in a linear order on the chromosomes and appear like beads on a string. Each gene was supposed to be different from all others. The particulate theory of gene was widely accepted and supported by cytological observations. But, the discovery of DNA molecule as a sole carrier of genetic information base altogether discarded the Morgan's theory. Therefore, before defining the gene it will be advisable to consider both the classical as well as modern definitions of gene.

### **Changing Concept of Gene**

The concept of gene has been the focal point of study from the beginning of twentieth century to establish the basis of heredity. The gene has been examined from two main angles, i.e., (1) genetic view, and (2) biochemical and molecular view. These aspects are briefly described below:

#### **(1) A Genetic View**

The genetic view or perspective of gene is based mainly on the Mendelian inheritance, chromosomal theory of inheritance and linkage studies. Mendel used the term factors for genes and reported that factors were responsible for transmission of characters from parents to their offspring. Sutton and Boveri (1903) based on the study of mitosis and meiosis in higher plants established parallel behaviour of chromosomes and genes. They reported that both chromosomes and genes segregate and exhibit random assortment, which clearly demonstrated that genes are located on chromosomes. The Sutton- Boveri hypothesis is known as chromosome theory of inheritance.

Morgan based on linkage studies in *Drosophila* reported that genes are located on the chromosome in a linear fashion. Some genes do not assort independently because of linkage between them. He suggested that recombinants are the result of crossing over. The crossing over increases if the distance between two genes is more. The number of linkage group is the same as the number of chromosomes. The chromosome theory and linkage studies reveal that genes are located on the chromosomes. This view is sometimes called as bead theory. The important points about the bead theory are given below:

1. The gene is viewed as a fundamental unit of structure, indivisible by crossing over. Crossing over occurs between genes but not within a gene.
2. The gene is considered as a basic unit of change or mutation. It changes from one allelic form to another, but there are no smaller components within a gene that can change.



3. The gene is viewed as a basic unit of function. Parts of a gene, if they exist, cannot function.

The chromosome has been viewed merely as a vector or transporter of genes and exists simply to permit their orderly segregation and to shuffle them in recombination. The bead theory is no more valid for any of the above three points. Now evidences are available which indicate that: (1) a gene is divisible (2) part of a gene can mutate, and (3) part of a gene can function.

### **The Gene is Divisible**

Earlier it was believed that gene is a basic unit of structure which is indivisible by crossing over. In other words, crossing over occurs between genes but not within a gene. Now intragenic recombination has been observed in many organisms which indicates that a gene is divisible. The intragenic recombination has following two main features.

1. It occurs with rare frequency so that a very large test cross progeny is required for its detection. Benzer expected to detect a recombination frequency as low as  $10^{-6}$ , the lowest he actually found was  $10^{-4}$  ( $0.01 \times 2 = 0.02\%$ ).
2. The alleles in which intragenic recombination occurs are separated by small distances within a gene and are functionally related.

Examples of intragenic recombination include bar eye, star asteroid eye and lozenge eye in *Drosophila*. The bar locus is briefly described below. Lozenge eye and star asteroid have been discussed under pseudoalleles.

### **Bar Eye in *Drosophila***

The first case of intragenic recombination was recorded in *Drosophila* for bar locus which controls size of eye. The bar locus contains more than one unit of function. The dominant bar gene in *Drosophila* produces slit like eye instead of normal oval eye. Bar phenotype is caused by tandem duplication of 16A region in X chromosome, which results due to unequal crossing over. The flies with different dose of 16A region have different types of eye as follows:

1. Single 16A region → Wild type oval eye
  2. Double 16A region → Bar eye small in size
  3. Triple 16A region → Double bar or ultrabar eye very small in size
- The homozygous bar eye (B/B) produced both wild and ultra bar types though at a low frequency which indicated intragenic recombination in the bar locus but the frequency was much higher than that expected due to spontaneous mutations.

### **Part of a Gene Can Function**

It was considered earlier that gene is the basic unit of function and parts of gene, if exist, cannot function. But this concept has been outdated now. Based on studies on rII locus of T4 phage, Banzer (1955) concluded that there are three sub divisions of a gene, viz., recon, muton and cistron. These are briefly described below:

#### **Recon**

Recons are the regions (units) within a gene between which recombinations can occur, but the recombination cannot occur within a recon. There is a minimum recombination distance within a gene which separates recons. The map of a gene is completely linear sequence of recons.

#### **Muton**

It is the smallest element within a gene, which can give rise to a mutant phenotype or mutation. This indicates that part of a gene can mutate or change. This disproved the bead theory according to which the entire gene was a mutator or change.

#### **Cistron**

It is the largest element within a gene which is the unit of function. This also knocked down the bead theory according to which entire gene was the unit of function. The name cistron has been derived from the test which is performed to know whether two mutants are within the same cistron or in different cistrons. It is called cis-trans test which is described below.

### **Cis – Trans Test**

When two mutations in trans position produce mutant phenotype, they are in the same cistron. Complementation in trans position (appearance of wild type) indicates that the mutant sites are in different cistrons. There is no complementation between mutations within a cistron.

It is now known that some genes consist of only one cistron ; some consist of two or even more. For example, the mutant miniature (m) and dusky (dy) both decrease wing size in *Drosophila* and map in the same part of X chromosome. But when brought together in dy +/+m heterozygote, the phenotype is normal which indicates that the locus concerned with wing size is composed of at least two cistrons.

### **(2) A Biochemical View**

It is now generally believed that a gene is a sequence of nucleotides in DNA which controls a single polypeptide chain. The different mutations of a gene may be due to change in single nucleotide at more than one location in the gene. Crossing over can take place between the altered nucleotides within a gene. Since the mutant nucleotides are placed so close together, crossing over is expected within very low frequency. When several different genes which affect the same trait are present so close that crossing over is rare between them, the term complex locus is applied to them. Within the nucleotide sequence of DNA, which represents a gene, multiple alleles are due to mutations at different points within the gene.

### **Fine Structure of Gene**

Benzer, in 1955, divided the gene into recon, muton and cistron which are the units of recombination, mutation and function within a gene. Several units of this type exist in a gene. In other words, each gene consists of several units of function, mutation and recombination. The fine structure of gene deals with mapping of individual gene locus. This is parallel to the mapping of chromosomes. In chromosome mapping, various genes are assigned on a chromosome, whereas in case of a gene several alleles are assigned to the same locus. The individual gene maps

are prepared with the help of intragenic recombination. Since the frequency of intragenic recombination is extremely low, very large population has to be grown to obtain such rare combination. Prokaryotes are suitable materials for growing large population. In *Drosophila*, 14 alleles of lozenge gene map at four mutational sites which belong to the same locus (Green, 1961). Similarly, for rosy eye in *Drosophila*, different alleles map at 10 mutational sites of the same locus.

Genes can be classified in various ways. The classification of genes is generally done on the basis of (1) dominance, (2) interaction, (3) character controlled, (4) effect on survival, (5) location, (6) movement, (7) nucleotide sequence, (8) sex linkage, (9) operon model, and (10) role in mutation. A brief classification of genes on the basis of above criteria is presented below

**Classification and brief description of genes**

<b>Classification of genes</b>	<b>of</b>	<b>A brief description</b>
<b>Based on Dominance</b>	<b>on</b>	
Dominant genes		Genes that express in the F <sub>1</sub>
Recessive genes		Genes whose effect is suppressed in F <sub>1</sub>
<b>Based on Interaction</b>	<b>on</b>	
Epistatic gene		A gene that has masking effect on the other gene controlling the same trait.
Hypostatic gene		A gene whose expression is masked by another gene governing the same trait
<b>Based on Character Controlled</b>		
Major gene		A gene that governs qualitative trait. Such genes have distinct phenotypic effects.
Minor gene		A gene which is involved in the expression of quantitative trait. Effect of such genes cannot be easily detected.

<p><b>Based on Effect on Survival</b></p> <p>Lethal gene</p> <p>Semi lethal gene</p> <p>Sub-vital gene</p> <p>Vital gene</p>	<p>A gene which leads to death of its carrier when in homozygous condition. It may be dominant or recessive.</p> <p>A gene that causes mortality of more than 50% of its carriers.</p> <p>A gene that causes mortality of less than 50% of its carriers.</p> <p>A gene that does not have lethal effect on its carriers.</p>
<p><b>Based on Location</b></p> <p>Nuclear genes</p> <p>Plasma genes</p>	<p>Genes that are found in nuclear genome in the chromosomes.</p> <p>Genes that are found in the cytoplasm in mitochondria and chloroplasts. Also called cytoplasmic or extranuclear genes.</p>
<p><b>Based on Position</b></p> <p>Normal genes</p> <p>Jumping genes</p>	<p>Genes that have a fixed position on the chromosomes. Most of the genes belong to this category</p> <p>Genes which keep on changing their position on the chromosome of a genome. Such genes have been reported in maize.</p>
<p><b>Based on Nucleotide sequence</b></p> <p>Normal genes</p> <p>Split gene</p> <p>Pseudo genes</p>	<p>Genes having continuous sequence of nucleotides which code for a single polypeptide chain.</p> <p>A gene having discontinuous sequence of nucleotides. Such genes have been reported in some eukaryotes. The intervening sequences do not code for amino acids.</p> <p>Genes having defective nucleotides which are non-functional. These genes are defective copies of some normal genes.</p>
<p><b>Based on Sex Linkage</b></p>	

Sex linked genes	Genes which are located on sex or X-chromosomes.
Sex limited genes	Genes which express in one sex only
Sex influenced genes	Genes whose expression depends on the sex of individual e.g., gene for baldness in humans.
<b>Based on Operon Model</b>	
Regulator gene	A gene found in lac operon of E.Coli which directs synthesis of a repressor
Operator gene	In lac operon, a gene which control the function of structural genes.
Promotor gene	A gene in lac operon of E.Coli which initiates mRNA synthesis
Structural genes	The genes in lac operon of E.Coli which control the synthesis of protein through mRNA.
<b>Based on role in Mutation</b>	
Mutable genes	Genes which exhibit higher mutation rate than others e.g., white eye gene in Drosophila.
Mutator genes	Genes which enhance the natural mutation rate of other genes in the same genome e.g., dotted gene in maize.
Antimutator genes	Genes which decrease the frequency of natural mutation of other genes in the same genome. Such genes are found in bacteria and bacteriophages.

### More about Genes

There are some genes which are different from normal genes either in terms of their nucleotide sequences or functions. Some examples of such genes are split gene, jumping gene, overlapping gene and pseudo gene. A brief description of each of these genes is presented below:

#### Split Genes

Usually a gene has a continuous sequence of nucleotides. In other words, there is no interruption in the nucleotide sequence of a gene. Such nucleotide sequence codes for a particular single polypeptide chain. However, it was observed that the sequence of nucleotides was not

continuous in case of some genes; the sequences of nucleotides were interrupted by intervening sequences. Such gene with interrupted sequence of nucleotides is referred to as split genes or interrupted genes. Thus, split genes have two types of sequences, viz., normal sequences and interrupted sequences.

1. Normal Sequence. This represented the sequence of nucleotides which are included in the mRNA which is translated from DNA of split gene. These sequences code for a particular polypeptide chain and are known as exons.
2. Interrupted Sequence: The intervening or interrupted sequence of split gene are known as introns. These sequences do not code for any peptide chain. Moreover, interrupted sequences are not included into mRNA which is transcribed from DNA of split genes. The interrupted sequences are removed from the mRNA during processing of the same. In other words, the intervening sequences are discarded in mRNA as they are non-coding sequences. The coding sequences or exons are joined by ligase enzyme.

The first case of split gene was reported for ovalbumin gene of chickens. The ovalbumin gene has been reported to consist of seven intervening sequences.. Later on interrupted sequences (split genes) were reported for beta globin gene of mice and rabbits, tRNA genes of yeast and ribosomal genes of *Drosophila*.

The intervening sequences are determined with the help of R loop technique. This technique consists of hybridization between mRNA and DNA of the same gene under ideal conditions, i.e., at high temperature and high concentration of formamide. The mRNA pairs with single strand of DNA. The non-coding sequences or intervening sequences of DNA make loop in such pairing. The number of loops indicates the number of interrupted sequences and the size of loop indicates length of the intervening sequence. These loops can be viewed under electron microscope. The ovalbumin gene has seven interrupted sequences (introns) and eight coding sequences (exons). The beta globin gene has been reported to have two intervening sequences, one 550 nucleotides long and the other 125 nucleotides long.

The intervening sequences are excised during processing to form mature mRNA molecule. Thus, about half of the ovalbumin gene is discarded during processing. Earlier it was believed that there is colinearity (correspondence) between the nucleotide sequence and the sequence of amino acids which it specifies. The discovery of split genes has disproved the concept of colinearity of genes. Now colinearity between genes and their products is considered as a chance rather than a rule. Split genes have been reported mostly in eukaryotes.

### **Jumping Genes**

Generally, a gene occupies a specific position on the chromosome called locus. However in some cases a gene keeps on changing its position within the chromosome and also between the chromosomes of the same genome. Such genes are known as jumping genes or transposons or transposable elements. The first case of jumping gene was reported by Barbara Mc-Clintock in maize as early as in 1950. However, her work did not get recognition for a long time like that of Mendel. Because she was much ahead of time and this was an unusual finding, people did not appreciate it for a long time. This concept was recognized in early seventies and McClintock was awarded Nobel Prize for this work in 1983.

Later on transposable elements were reported in the chromosome of *E. coli* and other prokaryotes. In *E. coli*, some DNA segments were found moving from one location to other location. Such DNA segments are detected by their presence at such a position in the nucleotide sequence, where they were not present earlier. The transposable elements are of two types, viz, insertion sequence and transposons.

1. Insertion Sequence. There are different types of insertion sequences each with specific properties. Such sequences do not specify for protein and are of very short length. Such sequence has been reported in some bacteria bacteriophages and plasmids.
2. Transposons. These are coding sequences which code for one or more proteins. They are usually very long sequences of nucleotides including several thousand base pairs.



Transposable elements are considered to be associated with chromosomal changes such as inversion and deletion. They are hot spots for such changes and are useful tools for the study of mutagenesis. In eukaryotes, moving DNA segments have been reported in maize, yeast and *Drosophila*.

### Overlapping Genes

Earlier it was believed that a nucleotide sequence codes only for one protein. Recent investigations with prokaryotes especially viruses have proved beyond doubt that some nucleotide sequences (genes) can code for two or even more proteins. The genes which code for more than one protein are known as overlapping genes. In case of overlapping genes, the complete nucleotide sequence codes for one protein and a part of such nucleotide sequence can code for another protein. Overlapping genes are found in tumor producing viruses such as  $\phi$  X 174, SV 40 and G4, in virus  $\phi$  X 174 gene A overlaps gene B. In virus SV 40, the same nucleotide sequence codes for the protein VP 3 and also for the coxoyl – terminal end of the protein VP2. In virus G4, the gene A overlaps gene B and gene E overlaps gene D. The gene of this virus also contains some portions of nucleotide sequences which are common for gene A and gene C.

### Pseudogenes

There are some DNA sequences, especially in eukaryotes, which are non-functional and defective copies of normal genes. These sequences do not have any function. Such DNA sequences or genes are known as pseudogenes. Pseudogenes have been reported in humans, mouse and *Drosophila*. The main features of pseudogenes are given below :

1. Pseudogenes are non functional or defective copies of some normal genes. These genes are found in large numbers.
2. These genes being defective cannot be translated.
3. These genes do not code for protein synthesis, means they do not have any significance.
4. The well known examples of pseudogenes are alpha and beta globin pseudogenes of mouse.

## **LAC OPERON CONCEPT**

### **History**

The term "operon" was first proposed in a short paper in the Proceedings of the French Academy of Sciences in 1960. From this paper, the so-called general theory of the operon was developed. This theory suggested that all genes are controlled by means of operons through a single feedback regulatory mechanism: repression. Later, it was discovered that the regulation of genes is a much more complicated process. Indeed, it is not possible to talk of a general regulatory mechanism, as there are many, and they vary from operon to operon. Despite modifications, the development of the operon concept is considered one of the landmark events in the history of molecular biology.

### **Components of operon**

#### **The structural genes**

The structural genes form a single long polycistronic mRNA molecule and the number of structural genes corresponds to the number of proteins. Each structural gene is controlled independently and transcribe mRNA molecule separately, this, depends on substrate to be utilized. Example: In lac operon three structural genes (Z, Y, A) are associated with lactose utilization. Beta-galactosidase is the product of lac Z that cleaves beta (1-4) linkage of lactose & releases the free monosaccharides. The enzyme permease (a product of lacY) facilitates the lactose the entry inside the bacterium. The enzyme transacylase is a product of lac A where no definite role has been assigned. The lac operon consists of a promoter (p) operator (o) together with structural genes. The lac operon cannot function in the presence of sugars other than lactose.

#### **The operator gene**

The operator gene is present adjacent to lac Z gene. The operator gene overlaps the promoter region. The lac repressor protein binds to the operator invitro & protect part of the promoter region from the digestion of DNase. The repressor protein binds to the operator & forms an operator

–repressor complex which in turn physically blocks the transcription of Z, Y & A genes by preventing the release of RNA polymerase to begin transcription.

### **The promoter gene**

The promoter gene is long nucleotide & continuous with the operator gene. The promoter gene lies between the operator & regulator gene, like operators the promoter region consists of palindromic sequences of nucleotides (i.e. show 2 fold geometry from a point). These palindromic sequences are recognized by such proteins that have symmetrically arranged subunits. This section of two fold symmetry is present on the CRP site (c-AMP receptor protein site that binds to a protein called CRP). The CRP is encoded by CRP gene, it has been shown experimentally that CRP gene binds to cAMP (cAMP found in e.coli & other organisms) molecule & form a cAMP CRP complex. This complex is required for transcription because it binds to promoter & enhances the attachment of RNA polymerase to the promoter therefore it increases the transcription & translation process.

### **The repressor (regulator) gene**

Regulator gene determines the transcription of structural gene. It is of two types-active & inactive repressor. It codes for amino acids of a defined repressor protein. After synthesis, the repressor molecules are diffused from the ribosome & bind to the operator in the absence of an inducer. Finally the path of RNA polymerase is blocked & mRNA is not transcribed consequently; no protein synthesis occurs. This type of mechanism occurs in inducible system of active repressor. Moreover when an inducer is present it binds to repressor proteins & forms an inducer – repressor complex. Due to formation of complex the repressor undergoes changes in the confirmation of shape & becomes inactive consequently the structural genes can synthesize the polycistronic mRNA and later synthesize enzyme.

In contrast in the reversible system the regulator gene synthesis repressor protein that is inactive & therefore fails to bind to

operator, consequently ,proteins are synthesized by the structural genes .however the repressor protein can be activated in the presence of an co-repressor. the co-repressor together with repressor proteins forms the repressor-co repressor complex. This complex binds to operator gene & blocks the protein synthesis

### **Types of operon**

#### **1. Lactose (Lac) operon**

The regulatory mechanism of operon is responsible for the utilization of lactose as a carbon source that is why it is called as lac operon. the lactose utilizing system consists of 2 types of components i.e the structural genes (lacZ, lacy, lacA) the products of which are required for transport and metabolism of lactose &regulatory genes (lacI, lacP, lacO).these two components together comprises of lac operon .one of the most key features is that operon provides a mechanism for the co-ordinated expression of structural genes controlled by regulatory genes. Operon shows polarity i.e. the genes Z, Y, A synthesize equally qualities of 3 enzymes beta-galactosidase by lac Z, permease by lac Y & acetylase by lac A. These are synthesized in an order i.e. beta-galactosidase at first and acetylase in the last.

#### **Regulation of lac operon**

Regulation of the lac operon by repressor is called negative control. The lac operon is also under positive control by CRP (or cAMP Receptor Protein; also known as CAP or catabolite activator protein). CRP or CAP is now thought to be bound to its lac binding site at all times (even during repression). During induction, the inducer (either the natural inducer, allolactose, or the synthetic inducer, IPTG, binds to the lac repressor. Inducer-bound repressor does not bind to operator sites. This allows RNA polymerase to bind to the promoter and start transcribing the lac operon.

<b>Negative (lac repressor)</b>	<b>-----Bound to DNA-----</b>	<b>Not</b>
		<b>bound to DNA</b>
<b>(Type of Control)</b>		<b>(Operon</b>
<b>off)</b>	<b>(Operon on)</b>	<b>)</b>

Positive(CRP protein) ----- Bound to DNA-----Not  
 bound to DNA  
 (Type of control) (Operon on) (Operon off)

## 2. Tryptophan (Trp) operon

The tryptophan operon of E.coli is responsible for the synthesis of the amino acids tryptophan regulation of this operon occurs in such a way that when tryptophan is present in the growth medium, Trp operon is not active but, when adequate trp is present, the transcription of the operon is inhibited, however when its supply is insufficient transcription occurs, the Trp is quite different from the lac operon in that trp acts directly in the repression system rather than as an inducer. Moreover since the trp operon encodes a set of bio-synthetic caranabolic rather than a catabolic enzyme neither glu nor c AMP –CAP has a role in the operon activity.

### Regulation of Trp Operon

Trp is synthesized in 5 steps each required a particular enzyme.in E.coli chromosome the genes encoding these enzymes are located adjacent to one another in the same order as they are used in the bio-synthetic pathway they are translated from a single polycistronic m RNA molecule. These genes are called TrpE, TrpP, TrpC, TrpB, TrpA, The TrpE gene is the first one translated. Adjacent to the Trp E gene are the promoter, the operator &2 region, called the leader and the attenuated which are designated as TrpL & TrpA respectively .the repressor gene TrpR is located quite for from the gene cluster. The regulatory protein of the repressor system o the TrpR operon is the product of the TrpR gene. mutations either in this gene or in the operator cause constitute initiation of transcription of Trp-m RNA on the lac operon. This regulatory protein is called Trp apo repressor &it does not bind to the operator, unless Trp is present. The apo repressor &the tryptophan molecule joins together to form an active trp repressor which binds to the operator. The reaction scheme is as follows:

Apo repressor (no trp) -----active repressor (transcription occurs)

Apo repressor+trp-----active repressor +operator-----  
----- inactive operator (transcription does not occur)

**ULTRA STRUCTURE OF CELL AND CELL ORGANELLES AND THEIR FUNCTIONS**

In 1665, an Englishman by the name of Robert Hooke examined thin slices of cork and observed that it was composed of numerous little boxes, fitted together like honey comb. Since these boxes resembled the compartment of monastery he named them as cells. The cork cells studied by Hooke were really empty boxes; they had lost their living matter, the protoplasm. After his discovery, the protoplasm in living cells were largely over looked due to its transparency. Today, with the help of special techniques, we are able to see not only the protoplasm but also many bodies inside it.

A general outline of a plant cell is as follows:

- I. Cell Wall
- II. Protoplasm
  - A. Protoplasmic reticulum
    1. Cytoplasm
    2. Endoplasmic reticulum
    3. Ribosomes
    4. Mitochondria
    5. Golgi apparatus
    6. Plastids
    7. Nucleus
    8. Plant cell vacuoles
    9. Peroxisomes
    10. Lysosomes
    11. spherosomes
  - B. Non-protoplasmic components
    1. Starch grains

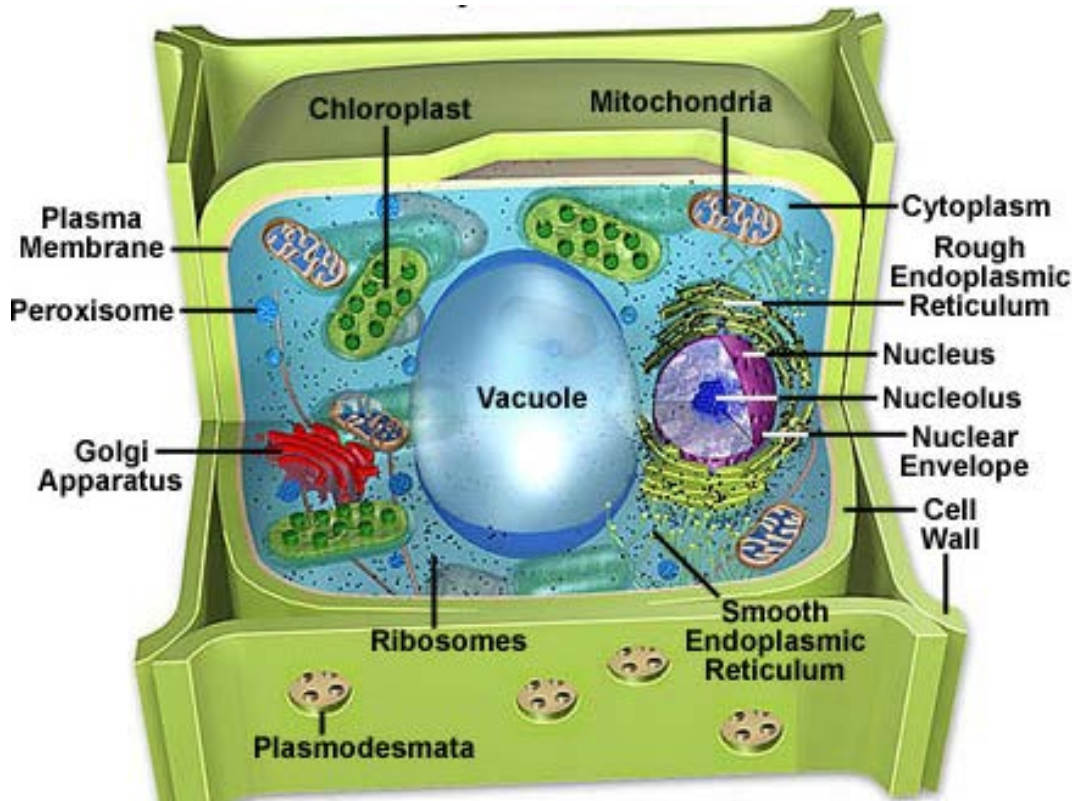

### Cell Wall

Plant cells are surrounded by a non living and rigid coat called cell wall. Though the cell wall is not a living part of the cell, it is an extra cytoplasmic product. Cell walls are significantly thicker than plasma membranes. It is responsible for the shape of plants and controls the growth rate of plant cells. It is a structural barrier to some molecules and invading insects. Cell walls are also a source of energy, fibre and food.

Walls are a layered structure, having three basic portions: intercellular substance or middle lamella, primary wall and secondary wall. The middle lamella cements together the primary walls of two contiguous cells and the secondary wall is laid over the primary. The middle lamella is mainly composed of a pectic compound which mostly appears to be calcium pectate. The primary wall is largely composed of cellulose and the secondary wall may be of cellulose or cellulose impregnated with other substances.

### Primary cell wall

The main chemical components of the primary plant cell wall include **cellulose** in the form of organized **microfibrils**, a complex carbohydrate made up of several thousand glucose molecules linked end to end. Cellulose constitutes the bulk of material of cell walls are made. It is soft, elastic, transparent and readily permeable to water. It is a carbohydrate, being



composed of three elements – carbon, hydrogen and oxygen. Cotton and linen are nearly pure cellulose. Cellophane, celluloid, paper rayon, synthetic lacquers and varnish are manufactured from cellulose. In addition, the cell wall contains two groups of branched polysaccharides, the **pectins** and **cross-linking glycans**. Pectic compounds are exceedingly gelatinous and viscous. They swell in water. They are found in three forms: insoluble pectose, soluble pectin and insoluble pectic acid. Organized into a network with the cellulose microfibrils, the cross-linking glycans increase the tensile strength of the cellulose, whereas the coextensive network of pectins provides the cell wall with the ability to resist compression. In addition to these networks, a small amount of protein can be found in all plant primary cell walls. Some of this protein is thought to increase mechanical strength and part of it consists of enzymes, which initiate reactions that form, remodel, or breakdown the structural networks of the wall. Such changes in the cell wall directed by enzymes are particularly important for fruit to ripen and leaves to fall in autumn.

Gums and mucilages are complex carbohydrates of the cell wall. They can absorb and retain water, helping in the dispersal of seeds.

One of the most important distinguishing features of plant cells is the presence of a cell wall. The relative rigidity of the cell wall renders plants sedentary, unlike animals, whose lack of this type of structure allows their cells more flexibility, which is necessary for locomotion. The plant cell wall serves a variety of functions. Along with protecting the intracellular contents, the structure bestows rigidity to the plant, provides a porous medium for the circulation and distribution of water, minerals, and other nutrients, and houses specialized molecules that regulate growth and protect the plant from disease.

### **Secondary cell wall**

The secondary plant cell wall, which is often deposited inside the primary cell wall as a cell matures, sometimes has a composition nearly identical to that of the earlier-developed wall. More commonly, however, additional substances, especially **lignin**, are found in the secondary wall. Lignin is the general name for a group of polymers of aromatic alcohols that are hard and impart considerable strength to the structure of the secondary wall. Lignin is what provides the favorable characteristics of wood to the fiber cells of woody tissues and is also common in the secondary walls of xylem vessels, which are central in providing structural support to plants. Lignin occurs generally in hard mature tissues, such as those straw and wood. It gives sufficient rigidity and strength to the plant body. It is permeable to water and solutes. Lignin also makes plant cell walls less vulnerable to attack by fungi or bacteria, as do **cutin**, **suberin**, and other waxy materials that are sometimes found in plant cell walls.

Cutin is a fatty substance. It forms an external coating, the cuticle on the outer cellulose wall of the epidermal cells of leaves and stems. It is not permeable to water. It is effective in protecting the foliage from the leaching effects of rain, in reducing water loss from plant surface and in preventing easy access of the partial parasites. The process of cutin deposition on the cellulose wall is called cutinisation.

Suberin is a fatty substance which resembles cutin in many qualities. It is permeable to water and checks the loss of water from the surface of plants. It is an important constituent of walls of cork cells, but also occur in the internal cells of exodermis and endodermis. The process of suberin deposition on the cellulose wall is termed suberisation.

### Middle lamella

A specialized region associated with the cell walls of plants, and sometimes considered an additional component of them, is the **middle lamella**. Rich in pectins, the middle lamella is shared by neighboring cells and cements them firmly together. Positioned in such a manner, cells are able to communicate with one another and share their contents through special conduits. Termed **plasmodesmata**, these small passages penetrate the middle lamella as well as the primary and secondary cell walls, providing pathways for transporting cytoplasmic molecules from one cell to another.

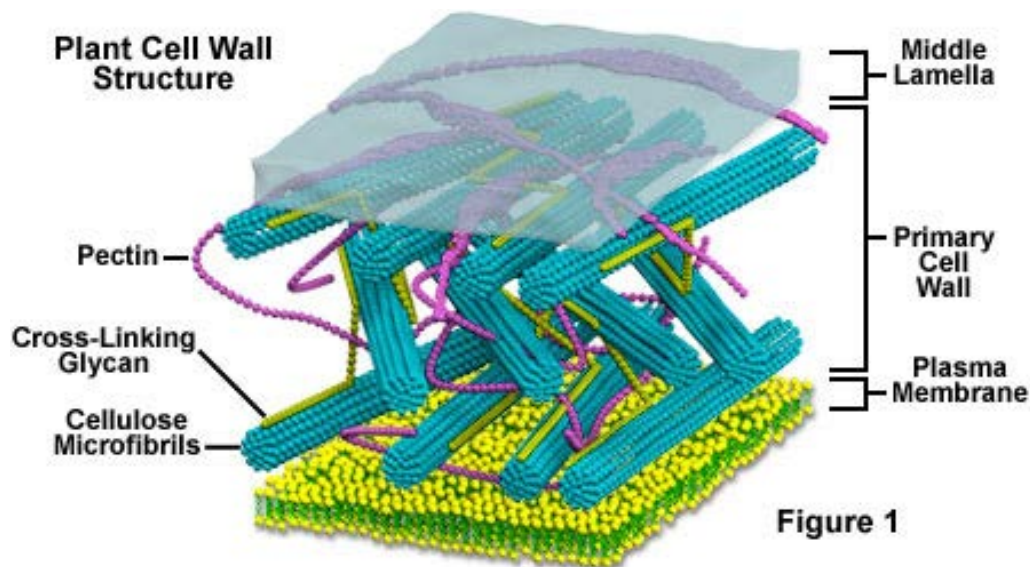

### Plasma Membrane

All living cells, prokaryotic and eukaryotic, have a plasma membrane that encloses their contents and serves as a semi-porous barrier to the outside environment. The membrane acts as a boundary, holding the cell constituents together and keeping other substances from

entering. The plasma membrane is permeable to specific molecules, however, and allows nutrients and other essential elements to enter the cell and waste materials to leave the cell. Small molecules, such as oxygen, carbon dioxide, and water, are able to pass freely across the membrane, but the passage of larger molecules, such as amino acids and sugars, is carefully regulated.

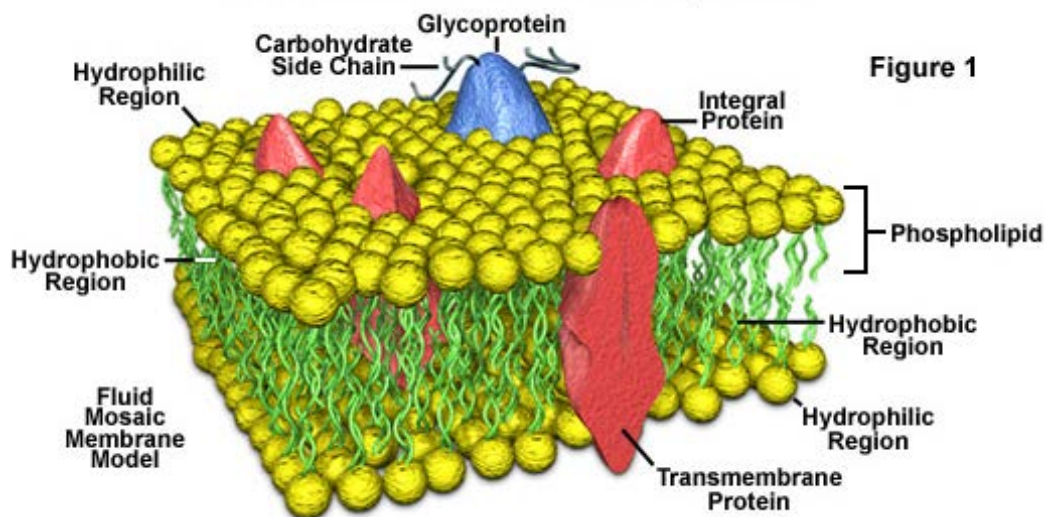

Figure 1

According to the accepted current theory, known as the **fluid mosaic model**, the plasma membrane is composed of a double layer (**bilayer**) of lipids, oily substances found in all cells. Most of the lipids in the bilayer can be more precisely described as **phospholipids**, that is, lipids that feature a phosphate group at one end of each molecule. Phospholipids are characteristically **hydrophilic** ("water-loving") at their phosphate ends and **hydrophobic** ("water-fearing") along their lipid tail regions. In each layer of a plasma membrane, the hydrophobic lipid tails are oriented inwards and the hydrophilic phosphate groups are aligned so they face outwards, either toward the aqueous cytosol of the cell or the outside environment. Phospholipids tend to spontaneously aggregate by this mechanism whenever they are exposed to water.

Within the phospholipid bilayer of the plasma membrane, many diverse proteins are embedded, while other proteins simply adhere to the surfaces of the bilayer. Some of these proteins, primarily those that are at least partially exposed on the external side of the membrane, have carbohydrates attached to their outer surfaces and are, therefore, referred to as **glycoproteins**. The positioning of proteins along the plasma membrane is related in part to the organization of the filaments that comprise the cytoskeleton, which help anchor them in place. The arrangement of proteins also involves the hydrophobic and hydrophilic regions found

on the surfaces of the proteins: hydrophobic regions associate with the hydrophobic interior of the plasma membrane and hydrophilic regions extend past the surface of the membrane into either the inside of the cell or the outer environment.

Plasma membrane proteins function in several different ways. Many of the proteins play a role in the selective transport of certain substances across the phospholipid bilayer, either acting as channels or active transport molecules. Others function as receptors, which bind information-providing molecules, such as hormones, and transmit corresponding signals based on the obtained information to the interior of the cell. Membrane proteins may also exhibit enzymatic activity, catalyzing various reactions related to the plasma membrane.

### Plasmodesmata

Plasmodesmata (singular, plasmodesma) are small channels that directly connect the cytoplasm of neighboring plant cells to each other, establishing living bridges between cells. The plasmodesmata, which penetrate both the primary and secondary cell walls allow certain molecules to pass directly from one cell to another and are important in cellular communication.

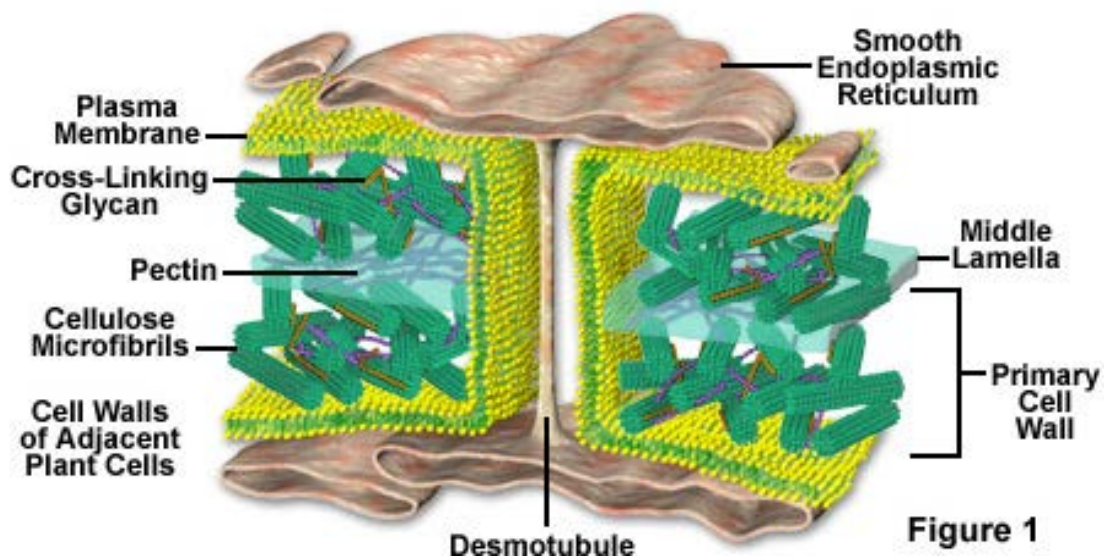

Due to the presence of plasmodesmata, plant cells can be considered to form a **syncytium**, or multinucleate mass with cytoplasmic continuity. Somewhat cylindrical in shape, plasmodesmata are lined with the plasma membrane so all connected cells are united through essentially one continuous cell membrane. A majority of plasmodesmata also contain a narrow tube-like structure called the **desmotubule**, which is derived from the smooth endoplasmic reticulum of the connected cells. The desmotubule does not completely fill the plasmodesma and, consequently, a ring of shared cytoplasm is located between it and the inner surface of the

membrane-lined channel. Plasmodesmata typically form during cell division when parts of the endoplasmic reticulum of the parent cell get trapped in the new cell wall that is produced to create daughter cells. Thousands of plasmodesmata may be formed that connect the daughter cells to one another.

It is widely thought that by constricting and dilating the openings at the ends of the plasmodesmata, plants cells regulate the passage of small molecules, such as sugars, salts, and amino acids, though this mechanism is not yet well understood. Yet, it is known that in some cases the size restrictions on molecule passage between cells can be overcome. By binding to parts of the plasmodesmata, special proteins and some viruses are able to increase the diameter of the channels enough for unusually large molecules to pass through.

### **Cytoplasm**

Part of plant cells outside the **nucleus** (and outside the large vacuole of plant cells) is called cytoplasm. Strictly speaking, this includes all the **organelles** (mitochondria, chloroplasts, and so on) and is the area in which most cell activities take place. However, cytoplasm is often used to refer to the jellylike matter in which the organelles are embedded (correctly termed the cytosol). Most of the activities in the cytoplasm are chemical reactions (metabolism), for example, protein synthesis.

In many cells, the cytoplasm is made up of two parts: the **ectoplasm** (or plasmagel), a dense gelatinous outer layer concerned with cell movement, and the **endoplasm** (or plasmasol), a more fluid inner part where most of the organelles are found. The semifluid medium between the nucleus and the plasma membrane is called **cytosol**.

### **The Endoplasmic Reticulum**

The endoplasmic reticulum (**ER**) is a network of flattened sacs and branching tubules that extends throughout the cytoplasm in plant and animal cells. These sacs and tubules are all interconnected by a single continuous membrane so that the organelle has only one large, highly convoluted and complexly arranged **lumen** (internal space). Usually referred to as the endoplasmic reticulum cisternal space, the lumen of the organelle often takes up more than 10 percent of the total volume of a cell. The endoplasmic reticulum membrane allows molecules to be selectively transferred between the lumen and the cytoplasm, and since it is connected to the double-layered nuclear envelope, it further provides a pipeline between the nucleus and the cytoplasm.



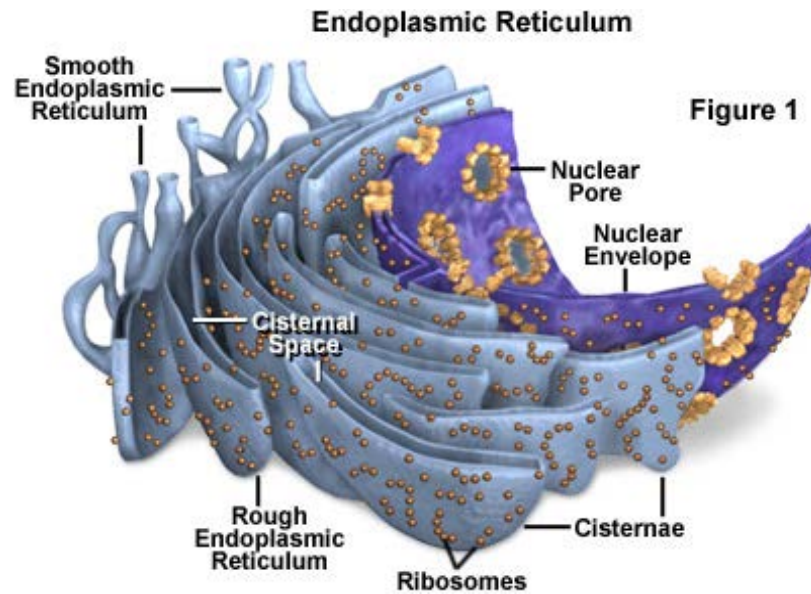

The endoplasmic reticulum manufactures, processes, and transports a wide variety of biochemical compounds for use inside and outside of the cell. Consequently, many of the proteins found in the cisternal space of the endoplasmic reticulum lumen are there only transiently as they pass on their way to other locations. Other proteins, however, are targeted to constantly remain in the lumen and are known as endoplasmic reticulum **resident proteins**. These special proteins, which are necessary for the endoplasmic reticulum to carry out its normal functions, contain a specialized retention signal consisting of a specific sequence of amino acids that enables them to be retained by the organelle. An example of an important endoplasmic reticulum resident protein is the chaperone protein known as **BiP** (formally: the chaperone immunoglobulin-binding protein), which identifies other proteins that have been improperly built or processed and keeps them from being sent to their final destinations.

There are two basic kinds of endoplasmic reticulum morphologies: rough and smooth. The surface of rough endoplasmic reticulum is covered with ribosomes, giving it a bumpy appearance when viewed through the microscope. This type of endoplasmic reticulum is involved mainly with the production and processing of proteins that will be exported, or secreted, from the cell.

The smooth endoplasmic reticulum in most cells is much less extensive than the rough endoplasmic reticulum and is sometimes alternatively termed **transitional**. Smooth endoplasmic reticulum is chiefly involved, however, with the production of lipids (fats), building blocks for carbohydrate metabolism, and the detoxification of drugs and poisons. Therefore, in some specialized cells, such as those that are occupied chiefly in lipid and carbohydrate

metabolism (brain and muscle) or detoxification (liver), the smooth endoplasmic reticulum is much more extensive and is crucial to cellular function. Smooth endoplasmic reticulum also plays a role in various cellular activities through its storage of calcium and involvement in calcium metabolism-

### Ribosomes

All living cells contain ribosomes, tiny organelles composed of approximately 60 percent ribosomal RNA (**rRNA**) and 40 percent protein. However, though they are generally described as organelles, it is important to note that ribosomes are not bound by a membrane and are much smaller than other organelles.

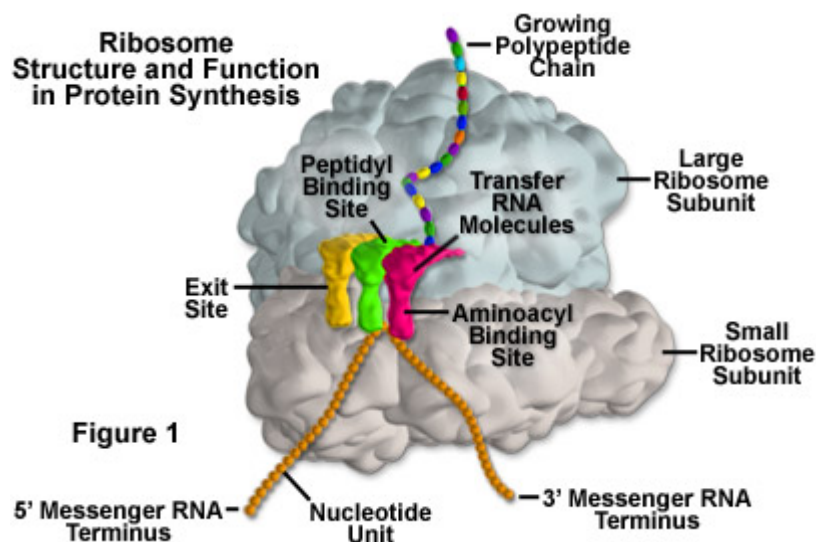

Ribosomes are mainly found bound to the endoplasmic reticulum and the nuclear envelope, as well as freely scattered throughout the cytoplasm, depending upon whether the cell is plant, animal, or bacteria.

In 2000, the complete three-dimensional structure of the large and small subunits of a ribosome was established. Evidence based on this structure suggests, as had long been assumed, that it is the rRNA that provides the ribosome with its basic formation and functionality, not proteins. Apparently the proteins in a ribosome help fill in structural gaps and enhance protein synthesis, although the process can take place in their absence, albeit at a much slower rate.

The units of a ribosome are often described by their Svedberg (**s**) values, which are based upon their rate of sedimentation in a centrifuge. The ribosomes in a eukaryotic cell generally have a Svedberg value of 80S and are comprised of 40s and 60s subunits.

Prokaryotic cells, on the other hand, contain 70S ribosomes, each of which consists of a 30s and a 50s subunit. As demonstrated by these values, Svedberg units are not additive, so the values of the two subunits of a ribosome do not add up to the Svedberg value of the entire organelle. This is because the rate of sedimentation of a molecule depends upon its size and shape, rather than simply its molecular weight.

Protein synthesis requires the assistance of two other kinds of RNA molecules in addition to rRNA. Messenger RNA (**mRNA**) provides the template of instructions from the cellular DNA for building a specific protein. Transfer RNA (**tRNA**) brings the protein building blocks, amino acids, to the ribosome. There are three adjacent tRNA binding sites on a ribosome: the **aminoacyl** binding site for a tRNA molecule attached to the next amino acid in the protein, the **peptidyl** binding site for the central tRNA molecule containing the growing peptide chain, and an **exit** binding site to discharge used tRNA molecules from the ribosome.

Once the protein backbone amino acids are polymerized, the ribosome releases the protein and it is transported to the cytoplasm in prokaryotes or to the Golgi apparatus in eukaryotes. There, the proteins are completed and released inside or outside the cell. Ribosomes are very efficient organelles. A single ribosome in a eukaryotic cell can add 2 amino acids to a protein chain every second. In prokaryotes, ribosomes can work even faster, adding about 20 amino acids to a polypeptide every second.

In addition to the most familiar cellular locations of ribosomes, the organelles can also be found inside mitochondria and the chloroplasts of plants. The similarity of mitochondrial and chloroplast ribosomes to prokaryotic ribosomes is generally considered strong supportive evidence that mitochondria and chloroplasts evolved from ancestral prokaryotes.

### **Mitochondria**

Mitochondria are rod-shaped organelles that can be considered the power generators of the cell, converting oxygen and nutrients into adenosine triphosphate (**ATP**). ATP is the chemical energy "currency" of the cell that powers the cell's metabolic activities.



### Mitochondria Structural Features

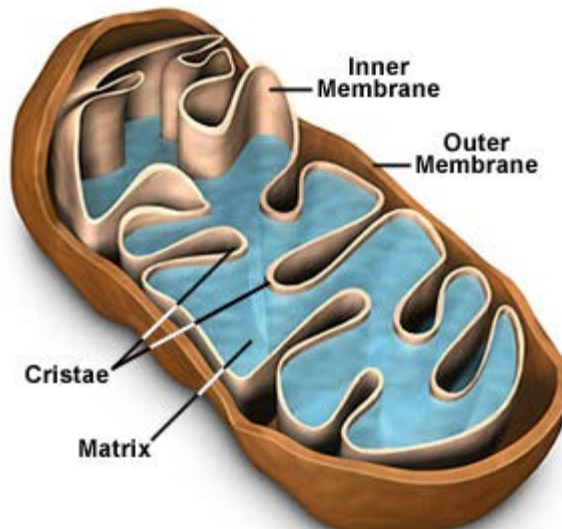

The number of mitochondria present in a cell depends upon the metabolic requirements of that cell, and may range from a single large mitochondrion to thousands of the organelles. Mitochondria, which are found in nearly all eukaryotes, including plants, animals, fungi, and protists, are large enough to be observed with a light microscope and were first discovered in the 1800s. The name of the organelles was coined to reflect the way they looked to the first scientists to observe them, stemming from the Greek words for "thread" and "granule." For many years after their discovery, mitochondria were commonly believed to transmit hereditary information. It was not until the mid-1950s when a method for isolating the organelles intact was developed that the modern understanding of mitochondrial function was worked out.

The elaborate structure of a mitochondrion is very important to the functioning of the organelle. Two specialized membranes encircle each mitochondrion present in a cell, dividing the organelle into a narrow **intermembrane space** and a much larger internal **matrix**, each of which contains highly specialized proteins. The outer membrane of a mitochondrion contains many channels formed by the protein **porin** and acts like a sieve, filtering out molecules that are too big. Similarly, the inner membrane, which is highly convoluted so that a large number of infoldings called **cristae** are formed, also allows only certain molecules to pass through it and is much more selective than the outer membrane. To make certain that only those materials essential to the matrix are allowed into it, the inner membrane utilizes a group of transport proteins that will only transport the correct molecules. Together, the various compartments of a mitochondrion are able to work in harmony to generate ATP in a complex multi-step process.

Mitochondria are generally oblong organelles, which range in size between 1 and 10 micrometers in length, and occur in numbers that directly correlate with the cell's level of metabolic activity. The organelles are quite flexible, however, studies have demonstrated that mitochondria change shape rapidly and move about in the cell almost constantly. Movements of the organelles appear to be linked in some way to the microtubules present in the cell, and are probably transported along the network with motor proteins. Consequently, mitochondria may be organized into lengthy traveling chains, packed tightly into relatively stable groups, or appear in many other formations based upon the particular needs of the cell and the characteristics of its microtubular network.

### **Golgi apparatus**

The Golgi apparatus (**GA**), also called Golgi body or Golgi complex and found universally in both plant and animal cells, is typically comprised of a series of five to eight cup-shaped, membrane-covered sacs called **cisternae** that look something like a stack of deflated balloons. In some unicellular flagellates, however, as many as 60 cisternae may combine to make up the Golgi apparatus. Similarly, the number of Golgi bodies in a cell varies according to its function. Animal cells generally contain between ten and twenty Golgi stacks per cell, which are linked into a single complex by tubular connections between cisternae. This complex is usually located close to the cell nucleus.

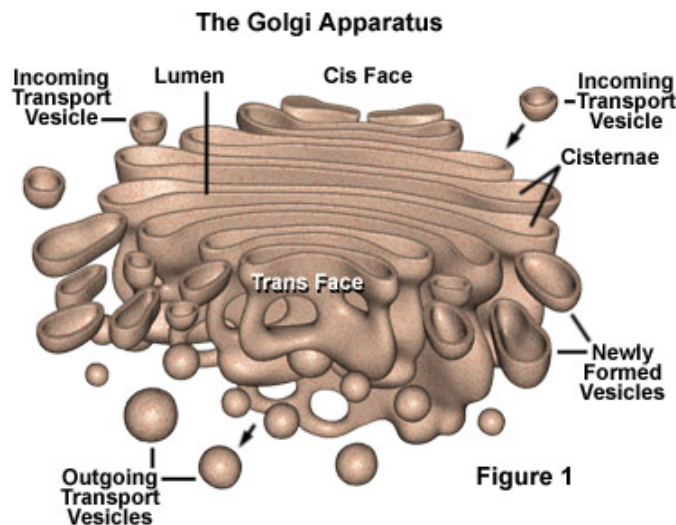

Due to its relatively large size, the Golgi apparatus was one of the first organelles ever observed. In 1897, an Italian physician named Camillo Golgi, who was investigating the nervous system by using a new staining technique he developed (and which is still sometimes used today; known as Golgi staining or Golgi impregnation), observed in a sample under his light

microscope a cellular structure that he termed the internal reticular apparatus. Soon after he publicly announced his discovery in 1898, the structure was named after him, becoming universally known as the Golgi apparatus. Yet, many scientists did not believe that what Golgi observed was a real organelle present in the cell and instead argued that the apparent body was a visual distortion caused by staining. The invention of the electron microscope in the twentieth century finally confirmed that the Golgi apparatus is a cellular organelle.

The Golgi apparatus is often considered the distribution and shipping department for the cell's chemical products. It modifies proteins and lipids (fats) that have been built in the endoplasmic reticulum and prepares them for export outside of the cell or for transport to other locations in the cell. Proteins and lipids built in the smooth and rough endoplasmic reticulum bud off in tiny bubble-like vesicles that move through the cytoplasm until they reach the Golgi complex. The vesicles fuse with the Golgi membranes and release their internally stored molecules into the organelle. Once inside, the compounds are further processed by the Golgi apparatus, which adds molecules or chops tiny pieces off the ends. When completed, the product is extruded from the GA in a vesicle and directed to its final destination inside or outside the cell. The exported products are secretions of proteins or glycoproteins that are part of the cell's function in the organism. Other products are returned to the endoplasmic reticulum or may undergo maturation to become lysosomes.

The modifications to molecules that take place in the Golgi apparatus occur in an orderly fashion. Each Golgi stack has two distinct ends, or faces. The **cis** face of a Golgi stack is the end of the organelle where substances enter from the endoplasmic reticulum for processing, while the **trans** face is where they exit in the form of smaller detached vesicles. Consequently, the cis face is found near the endoplasmic reticulum, from whence most of the material it receives comes, and the trans face is positioned near the plasma membrane of the cell, to where many of the substances it modifies are shipped. The chemical make-up of each face is different and the enzymes contained in the lumens (inner open spaces) of the cisternae between the faces are distinctive.

Proteins, carbohydrates, phospholipids, and other molecules formed in the endoplasmic reticulum are transported to the Golgi apparatus to be biochemically modified during their transition from the cis to the trans poles of the complex. Enzymes present in the Golgi lumen modify the carbohydrate (or sugar) portion of glycoproteins by adding or subtracting individual sugar monomers. In addition, the Golgi apparatus manufactures a variety of macromolecules on its own, including a variety of polysaccharides. The Golgi complex in plant cells produces pectins and other polysaccharides specifically needed by for plant structure and metabolism.

The products exported by the Golgi apparatus through the trans face eventually fuse with the plasma membrane of the cell. Among the most important duties of the Golgi apparatus is to sort the wide variety of macromolecules produced by the cell and target them for distribution to their proper location. Specialized molecular identification labels or tags, such as phosphate groups, are added by the Golgi enzymes to aid in this sorting effort.

### **Plastids**

In most plant cells structures called plastids are found. They are found in the cytoplasmic matrix of plant cells only. These structures are generally spherical or ovoid in shape and they are clearly visible in living cells. 3 types of plastids found in plant cells:

#### **Chromoplasts**

Chromoplasts are red, yellow or orange in colour and are found in petals of flowers and in fruit. Their colour is due to two pigments, carotene and xanthophyll.

#### **Functions**

the primary function in the cells of flowers is to attract agents of pollination, and in fruit to attract agents of dispersal.

#### **Leucoplasts**

Leucoplasts are colourless plastids and occur in plant cells not exposed to light, such as roots and seeds. They are colourless due the absent of pigments.

#### **Functions**

leucoplasts are the centers of starch grain formation; they are also involved in the synthesis of oils and proteins.

#### **Chloroplasts**

Chloroplasts are probably the most important among the plastids since they are directly involved in photosynthesis. They are usually situated near the surface of the cell and occur in those parts that receive sufficient light, e.g. the palisade cells of leaves. The green colour of chloroplasts is caused by the green pigment chlorophyll.

One of the most widely recognized and important characteristics of plants is their ability to conduct **photosynthesis**, in effect, to make their own food by converting light energy into chemical energy. This process occurs in almost all plant species and is carried out in specialized organelles known as chloroplasts. All of the green structures in plants, including stems and unripened fruit, contain chloroplasts, but the majority of photosynthesis activity in most plants occurs in the leaves. On the average, the chloroplast density on the surface of a leaf is about one-half million per square millimeter.

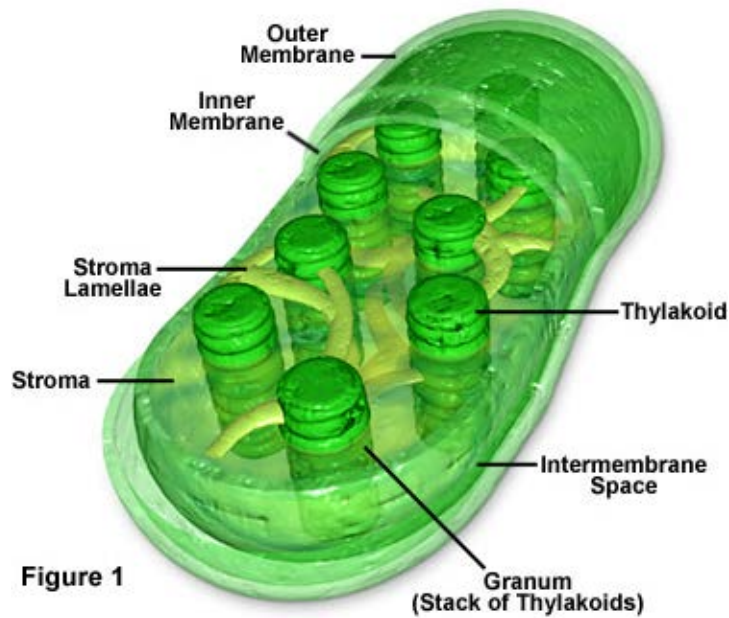

All plastids develop from tiny organelles found in the immature cells of plant meristems (undifferentiated plant tissue) termed **proplastids**, and those of a particular plant species contain copies of the same circular genome. The disparities between the various types of plastids are based upon the needs of the differentiated cells they are contained in, which may be influenced by environmental conditions, such as whether light or darkness surrounds a leaf as it grows.

The ellipsoid-shaped chloroplast is enclosed in a double membrane and the area between the two layers that make up the membrane is called the **intermembrane space**. The outer layer of the double membrane is much more permeable than the inner layer, which features a number of embedded membrane transport proteins. Enclosed by the chloroplast membrane is the **stroma**, a semi-fluid material that contains dissolved enzymes and comprises most of the chloroplast's volume. Since, like mitochondria, chloroplasts possess their own genomes (DNA), the stroma contains chloroplast DNA and special ribosomes and RNAs as well. In higher plants, **lamellae**, internal membranes with stacks (each termed a **granum**) of closed hollow disks called **thylakoids**, are also usually dispersed throughout the stroma. The numerous thylakoids in each stack are thought to be connected via their lumens (internal spaces).

Light travels as packets of energy called photons and is absorbed in this form by light-absorbing chlorophyll molecules embedded in the thylakoid disks. When these chlorophyll

molecules absorb the photons, they emit electrons, which they obtain from water (a process that results in the release of oxygen as a byproduct). The movement of the electrons causes hydrogen ions to be propelled across the membrane surrounding the thylakoid stack, which consequently initiates the formation of an electrochemical gradient that drives the stroma's production of adenosine triphosphate (**ATP**). ATP is the chemical energy "currency" of the cell that powers the cell's metabolic activities. In the stroma, the light-independent reactions of photosynthesis, which involve carbon fixation, occur, and low-energy carbon dioxide is transformed into a high-energy compound like glucose.

### **NUCLEUS**

The nucleus is a highly specialized organelle that serves as the information processing and administrative center of the cell. This organelle has two major functions: it stores the cell's hereditary material, or DNA, and it coordinates the cell's activities, which include growth, intermediary metabolism, protein synthesis, and reproduction (cell division).

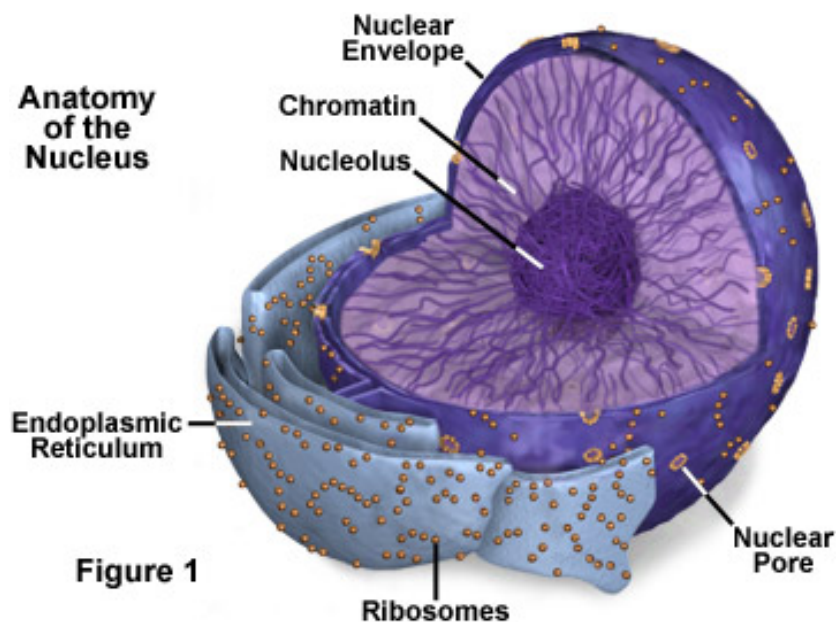

The spherical nucleus typically occupies about 10 percent of a eukaryotic cell's volume, making it one of the cell's most prominent features. A double-layered membrane, the nuclear envelope, separates the contents of the nucleus from the cellular cytoplasm. The envelope is riddled with holes called nuclear pores that allow specific types and sizes of molecules to pass back and forth between the nucleus and the cytoplasm. It is also attached to a network of tubules and sacs, called the endoplasmic reticulum, where protein synthesis occurs, and is usually studded with ribosome.



The semifluid matrix found inside the nucleus is called nucleoplasm. Within the nucleoplasm, most of the nuclear material consists of chromatin, the less condensed form of the cell's DNA that organizes to form chromosomes during mitosis or cell division. The nucleus also contains one or more nucleoli, organelles that synthesize protein-producing macromolecular assemblies called ribosomes, and a variety of other smaller components, such as Cajal bodies, **GEMS** (Gemini of coiled bodies), and interchromatin granule clusters.

### **Chromatin and Chromosomes**

Packed inside the nucleus of every human cell is nearly 6 feet of DNA, which is divided into 46 individual molecules, one for each chromosome and each about 1.5 inches long. For DNA to function, it is combined with proteins and organized into a precise, compact structure, a dense string-like fiber called chromatin.

### **The Nucleolus**

The nucleolus is a membrane-less organelle within the nucleus that manufactures ribosomes, the cell's protein-producing structures. The nucleolus looks like a large dark spot within the nucleus. A nucleus may contain up to four nucleoli, but within each species the number of nucleoli is fixed. After a cell divides, a nucleolus is formed when chromosomes are brought together into nucleolar organizing regions. During cell division, the nucleolus disappears.

### **The Nuclear Envelope**

The nuclear envelope is a double-layered membrane that encloses the contents of the nucleus during most of the cell's lifecycle. The space between the layers is called the perinuclear space and appears to connect with the rough endoplasmic reticulum. The envelope is perforated with tiny holes called nuclear pores. These pores regulate the passage of molecules between the nucleus and cytoplasm, permitting some to pass through the membrane, but not others. The inner surface has a protein lining called the nuclear lamina, which binds to chromatin and other nuclear components. During mitosis, or cell division, the nuclear envelope disintegrates, but reforms as the two cells complete their formation and the chromatin begins to unravel and disperse.

### **Nuclear Pores**

The nuclear envelope is perforated with holes called nuclear pores. These pores regulate the passage of molecules between the nucleus and cytoplasm, permitting some to pass through the membrane, but not others. Building blocks for building DNA and RNA are allowed into the nucleus as well as molecules that provide the energy for constructing genetic material.

## Peroxisomes

Microbodies are a diverse group of organelles that are found in the cytoplasm of almost all cells, roughly spherical, and bound by a single membrane. There are several types of microbodies, including lysosomes, but peroxisomes are the most common. All eukaryotes are comprised of one or more cells that contain peroxisomes. The organelles were first discovered by the Belgian scientist Christian de Duve, who also discovered lysosomes.

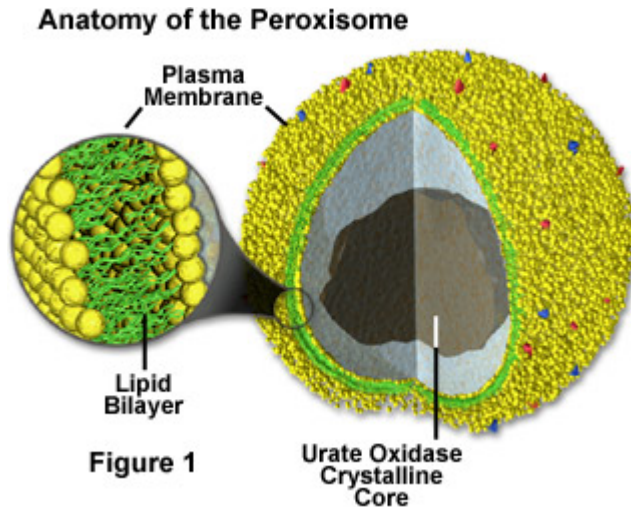

Peroxisomes contain a variety of enzymes, which primarily function together to rid the cell of toxic substances, and in particular, hydrogen peroxide (a common byproduct of cellular metabolism). These organelles contain enzymes that convert the hydrogen peroxide to water, rendering the potentially toxic substance safe for release back into the cell. Some types of peroxisomes, such as those in liver cells, detoxify alcohol and other harmful compounds by transferring hydrogen from the poisons to molecules of oxygen (a process termed **oxidation**). Others are more important for their ability to initiate the production of phospholipids, which are typically used in the formation of membranes.

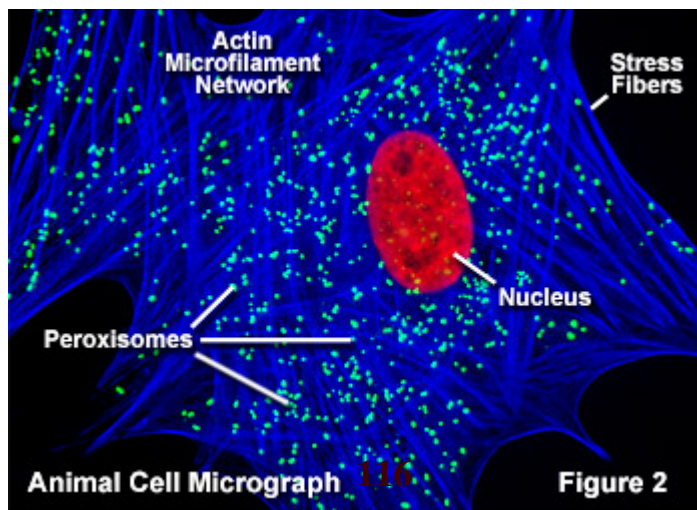



### Plant Cell Vacuoles

Vacuoles are membrane-bound sacs within the cytoplasm of a cell that function in several different ways. In mature plant cells, vacuoles tend to be very large and are extremely important in providing structural support, as well as serving functions such as storage, waste disposal, protection, and growth. Many plant cells have a large, single **central vacuole** that typically takes up most of the room in the cell (80 percent or more). Vacuoles in animal cells, however, tend to be much smaller, and are more commonly used to temporarily store materials or to transport substances.

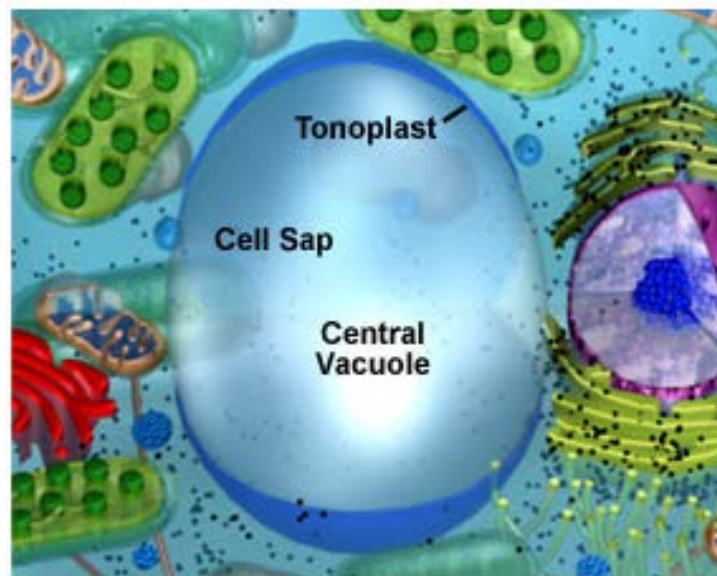

The central vacuole in plant cells is enclosed by a membrane termed the **tonoplast**, an important and highly integrated component of the plant internal membrane network (**endomembrane**) system. This large vacuole slowly develops as the cell matures by fusion of smaller vacuoles derived from the endoplasmic reticulum and Golgi apparatus. Because the central vacuole is highly selective in transporting materials through its membrane, the chemical palette of the vacuole solution (termed the **cell sap**) differs markedly from that of the surrounding cytoplasm. For instance, some vacuoles contain pigments that give certain flowers their characteristic colors. The central vacuole also contains plant wastes that taste bitter to insects and animals, while developing seed cells use the central vacuole as a repository for protein storage.

Among its roles in plant cell function, the central vacuole stores salts, minerals, nutrients, proteins, pigments, helps in plant growth, and plays an important structural role for the plant.

Under optimal conditions, the vacuoles are filled with water to the point that they exert a significant pressure against the cell wall. This helps maintain the structural integrity of the plant, along with the support from the cell wall, and enables the plant cell to grow much larger without having to synthesize new cytoplasm. In most cases, the plant cytoplasm is confined to a thin layer positioned between the plasma membrane and the tonoplast, yielding a large ratio of membrane surface to cytoplasm.

The structural importance of the plant vacuole is related to its ability to control **turgor pressure**. Turgor pressure dictates the rigidity of the cell and is associated with the difference between the osmotic pressure inside and outside of the cell. Osmotic pressure is the pressure required to prevent fluid diffusing through a semipermeable membrane separating two solutions containing different concentrations of solute molecules. The response of plant cells to water is a prime example of the significance of turgor pressure. When a plant receives adequate amounts of water, the central vacuoles of its cells swell as the liquid collects within them, creating a high level of turgor pressure, which helps maintain the structural integrity of the plant, along with the support from the cell wall. In the absence of enough water, however, central vacuoles shrink and turgor pressure is reduced, compromising the plant's rigidity so that wilting takes place.

Plant vacuoles are also important for their role in molecular degradation and storage. Sometimes these functions are carried out by different vacuoles in the same cell, one serving as a compartment for breaking down materials (similar to the lysosomes found in animal cells), and another storing nutrients, waste products, or other substances. Several of the materials commonly stored in plant vacuoles have been found to be useful for humans, such as opium, rubber, and garlic flavoring, and are frequently harvested. Vacuoles also often store the pigments that give certain flowers their colors, which aid them in the attraction of bees and other pollinators, but also can release molecules that are poisonous, odoriferous, or unpalatable to various insects and animals, thus discouraging them from consuming the plant.

### **Amyloplast (Starch Grain)**

A membrane-bound organelle containing concentric layers of starch (amylopectin). This organelle is commonly found in subterranean storage organs, such as tubers (potatoes), corms (taro & dasheen), and storage roots (sweet potatoes). Amyloplasts are also found in bananas and other fruits.

## **Study of chromosome structure, morphology, number and types - Karyotype and Idiogram**

A chromosome is a structure that occurs within cells and that contains the cell's genetic material. That genetic material, which determines how an organism develops, is a molecule of deoxyribonucleic acid (DNA). A molecule of DNA is a very long, coiled structure that contains many identifiable subunits known as genes. In prokaryotes, or cells without a nucleus, the chromosome is merely a circle of DNA. In eukaryotes, or cells with a distinct nucleus, chromosomes are much more complex in structure.

### **Historical background**

The terms chromosome and gene were used long before biologists really understood what these structures were. When the Austrian monk and biologist Gregor Mendel (1822–1884) developed the basic ideas of heredity, he assumed that genetic traits were somehow transmitted from parents to offspring in some kind of tiny "package." That package was later given the name "gene." When the term was first suggested, no one had any idea as to what a gene might look like. The term was used simply to convey the idea that traits are transmitted from one generation to the next in certain discrete units.

The term "chromosome" was first suggested in 1888 by the German anatomist Heinrich Wilhelm Gottfried von Waldeyer-Hartz (1836–1921). Waldeyer-Hartz used the term to describe certain structures that form during the process of cell division (reproduction).

One of the greatest breakthroughs in the history of biology occurred in 1953 when American biologist James Watson and English chemist Francis Crick discovered the chemical structure of a class of compounds known as deoxyribonucleic acids (DNA). The Watson and Crick discovery made it possible to express biological concepts (such as the gene) and structures (such as the chromosome) in concrete chemical terms.

According to the classical cytological studies, each chromosome structurally consists of a limiting membrane called pellicle, an amorphous matrix and two very thin, highly coiled filaments called chromonema or chromonemata. Each chromonemata is 800Å thick and contains 8-microfibrils, each of which in its turn contains two double helices of DNA. Both chromonematae remain intimately coiled in spiral manner with each other and have a series of microscopically visible bead-like swelling along its length called chromomeres. The early geneticists have attached great significance to the chromomeres and erroneously considered them as hereditary unit, hereditary or Mendelian factors or genes; but modern cytological investigations have confirmed that the chromomeres are not genes but the regions of super-imposed coils.

The recent cytological findings have also condemned the view that chromosomes have pellicle, matrix and chromonemata.

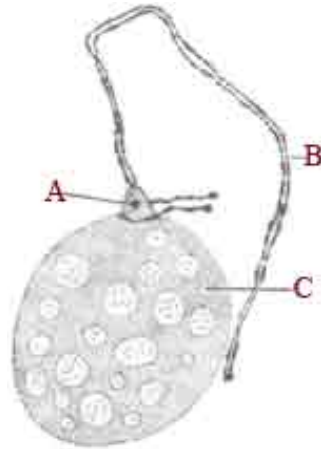

**A. Nucleolus organizer**

**B. Chromosome**

**C. Nucleolus**

### **The structure of chromosomes and genes**

A chromosome is an organized structure of DNA and protein that is found in cells. A chromosome is a single piece of coiled DNA containing many genes, regulatory elements and other nucleotide sequences. Chromosomes also contain DNA-bound proteins, which serve to package the DNA and control its functions. The word *chromosome* comes from the Greek *chroma* - color and *soma* - body due to their property of being very strongly stained by particular dyes. Chromosomes vary widely between different organisms. The DNA molecule may be circular or linear, and can be composed of 10,000 to 1,000,000,000 nucleotides in a long chain. Typically eukaryotic cells (cells with nuclei) have large linear chromosomes and prokaryotic cells (cells without defined nuclei) have smaller circular chromosomes, although there are many exceptions to this rule.

Today we know that a chromosome contains a single molecule of DNA along with several kinds of proteins. A molecule of DNA, in turn, consists of thousands and thousands of subunits, known as nucleotides, joined to each other in very long chains. A single molecule of DNA within a chromosome may be as long as 8.5 centimeters (3.3 inches). To fit within a chromosome, the DNA molecule has to be twisted and folded into a very complex shape.

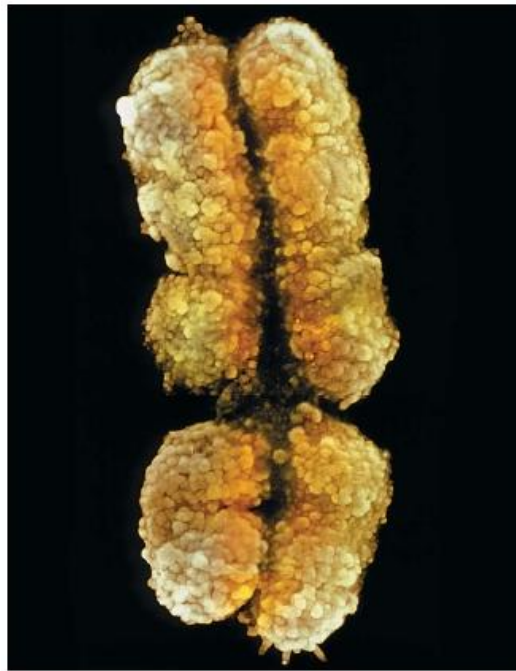

Each chromosome has a constriction point called the centromere, which divides the chromosome into two sections, or “arms.” The short arm of the chromosome is labeled the “p arm.” The long arm of the chromosome is labeled the “q arm.” The location of the centromere on each chromosome gives the chromosome its characteristic shape, and can be used to help describe the location of specific genes.

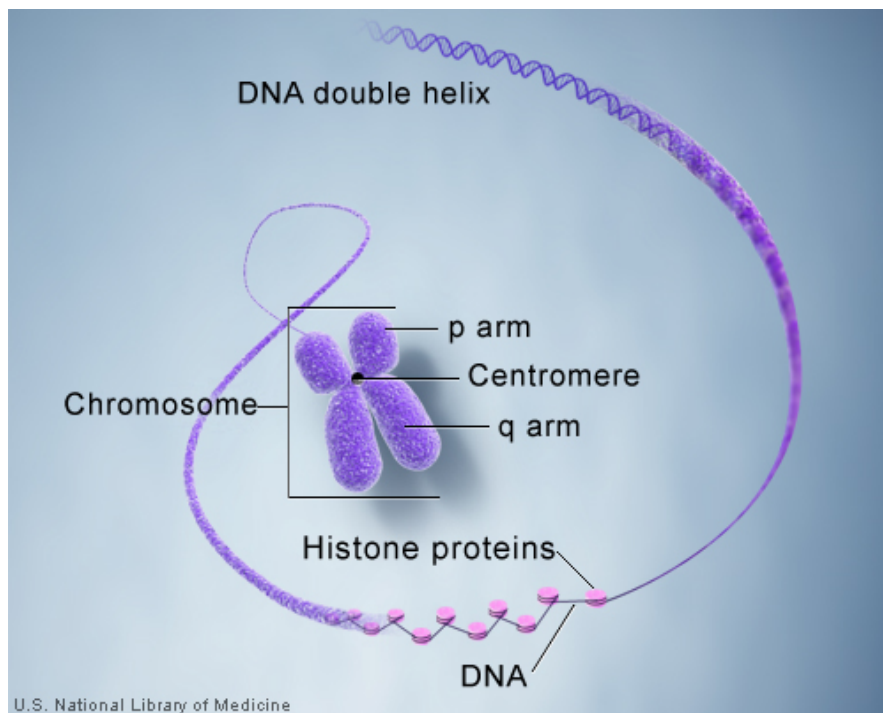

**The arrangement of packets of genetic information in a chromosome is as follows:**

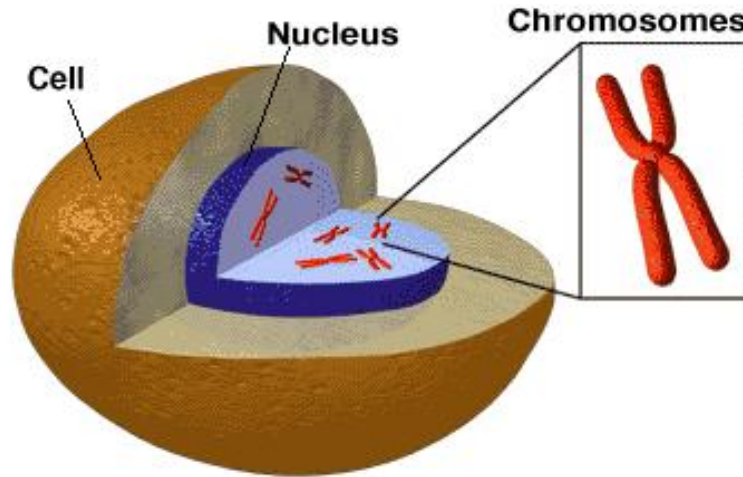

Furthermore, cells may contain more than one type of chromosome; for example, mitochondria in most eukaryotes and chloroplasts in plants have their own small chromosomes. The following are the different types of chromosomes

### **Viral Chromosomes**

The chromosomes of viruses are called viral chromosomes. They occur singly in a viral species and chemically may contain either DNA or RNA. The DNA containing viral chromosomes may be either of linear shape (e.g., T2, T3, T4, T5, bacteriophages) or circular shape (e.g., most animal viruses and certain bacteriophages). The RNA containing viral chromosomes are composed of a linear, single-stranded RNA molecule and occur in some animal viruses (e.g., poliomyelitis virus, influenza virus, etc.); most plant viruses, (e.g., tobacco mosaic virus, TMV) and some bacteriophages. Both types of viral chromosomes are either tightly packed within the capsids of mature virus particles (virions) or occur freely inside the host cell.

### **Prokaryotic Chromosomes**

The prokaryotes usually consists of a single giant and circular chromosome in each of their nucloids. Each prokaryotic chromosome consists of a single circular, double-stranded DNA molecule; but has no protein and RNA around the DNA molecule like eukaryotes. Different prokaryotic species have different sizes of chromosome.

### **Eukaryotic Chromosomes**

The eukaryotic chromosomes differ from the prokaryotic chromosomes in morphology, chemical composition and molecular structure. The eukaryotes (plants and animals) usually contain much more genetic informations than the viruses and prokaryotes, therefore, contain a great amount of genetic material, DNA molecule which here may not occur as a single unit, but,



## Principles of Genetics

as many units called chromosomes. Different species of eukaryotes have different but always constant and characteristic number of chromosomes. In eukaryotes, nuclear chromosomes are packaged by proteins into a condensed structure called chromatin. This allows the very long DNA molecules to fit into the cell nucleus. The shape of the eukaryotic chromosomes is changeable from phase to phase in the continuous process of the cell growth and cell division. Chromosomes are the essential unit for cellular division and must be replicated, divided, and passed successfully to their daughter cells so as to ensure the genetic diversity and survival of their progeny. They are thin, coiled, elastic, contractile thread-like structures during the interphase (when no division of cell occurs) and are called chromatin threads which under low magnification look like a compact stainable mass, often called as chromatin substance or material. During metaphase stage of mitosis and prophase of meiosis, these chromatin threads become highly coiled and folded to form compact and individually distinct ribbon-shaped chromosomes. These chromosomes contain a clear zone called kinetochore or centromere along their length.

Eukaryotes (cells with nuclei such as plants, yeast, and animals) possess multiple large linear chromosomes contained in the cell's nucleus. Each chromosome has one centromere, with one or two arms projecting from the centromere, although, under most circumstances, these arms are not visible as such. In addition, most eukaryotes have a small circular mitochondrial genome, and some eukaryotes may have additional small circular or linear cytoplasmic chromosomes.

The number and position of centromeres is variable, but is definite in a specific chromosome of all the cells and in all the individuals of the same species. Thus, according to the number of the centromere the eukaryotic chromosomes may be acentric (without any centromere), monocentric (with one centromere), dicentric (with two centromeres) or polycentric (with more than two centromeres). The centromere has small granules or spherules and divides the chromosomes into two or more equal or unequal chromosomal arms.

According to the position of the centromere, the eukaryotic chromosomes may be rod-shaped (telocentric and acrocentric), J-shaped (submetacentric) and V-shaped (metacentric). During the cell divisions the microtubules of the spindle are get attached with the chromosomal centromeres and move them towards the opposite poles of cell. Beside centromere, the chromosomes may bear terminal unipolar segments called telomeres. Certain chromosomes

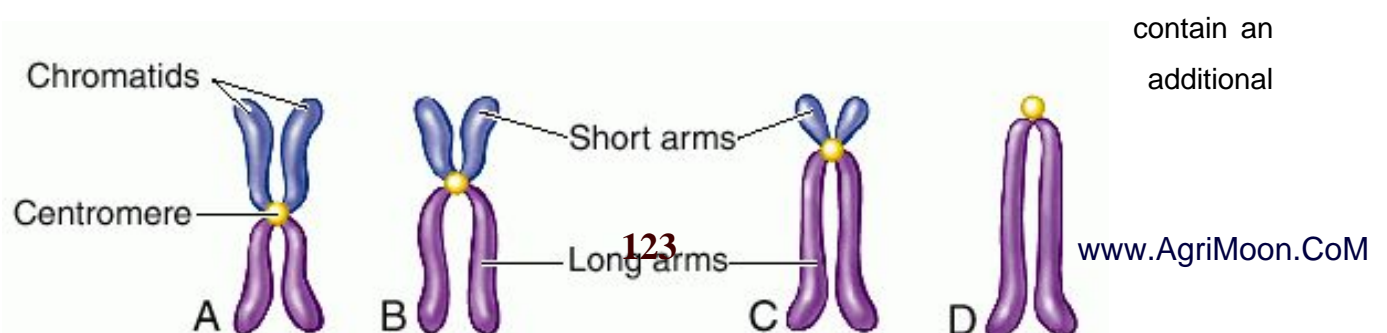

specialized segment, the nucleolus organizer, which is associated with the nucleolus.

**Position of the centromere in (A) metacentric; (B) submetacentric; (C) acrocentric; and (D) telocentric chromosomes.**



**A. Centromere**

Acrocentric

Telocentric

Metacentric

Sub metacentric

In the nuclear chromosomes of eukaryotes, the uncondensed DNA exists in a semi-ordered structure, where it is wrapped around histones (structural proteins), forming a composite material called chromatin. Chromatin is the complex of DNA and protein found in the eukaryotic nucleus which packages chromosomes. The structure of chromatin varies significantly between different stages of the cell cycle, according to the requirements of the DNA.

**Interphase chromatin**

During interphase (the period of the cell cycle where the cell is not dividing), two types of chromatin can be distinguished. The density of the chromatin that makes up each chromosome (that is, how tightly it is packed) varies along the length of the chromosome.

dense regions are called heterochromatin

less dense regions are called euchromatin.

- Euchromatin, which consists of DNA that is active, e.g., being expressed as protein.
- Heterochromatin, which consists of mostly inactive DNA. It seems to serve structural purposes during the chromosomal stages. Heterochromatin can be further distinguished into two types:
  - Constitutive heterochromatin, which is never expressed. It is located around the centromere and usually contains repetitive sequences.



- Facultative heterochromatin, which is sometimes expressed.

Individual chromosomes cannot be distinguished at this stage - they appear in the nucleus as a homogeneous tangled mix of DNA and protein.

### **Diploids and Haploids**

In contrast to prokaryotes, most eukaryotes are diploids, i.e., each somatic cell of them contains one set of chromosomes inherited from the maternal (female) parent and a comparable set of chromosomes (called homologous chromosomes) from the paternal (male) parent. The number of chromosomes in a dual set of a diploid somatic cell is called the diploid number ( $2n$ ). The sex cells (sperms and ova) of a diploid eukaryote cell contain half the number of chromosomal sets found in the somatic cells and are known as haploid ( $n$ ) cells. A haploid set of chromosome is also called genome. The fertilization process restores the diploid number of a diploid species.

### **Chemical Structure of Chromosomes**

Chemically, the eukaryotic chromosomes are composed of deoxyribonucleic acid (DNA), ribonucleic acid (RNA), histone and non-histone proteins and certain metallic ions. The histone proteins have basic properties and have significant role in controlling or regulating the functions of chromosomal DNA. The non-histone proteins are mostly acidic and have been considered more important than histones as regulatory molecules. Some non-histone proteins also have enzymatic activities. The most important enzymatic proteins of chromosomes are phosphoproteins, DNA polymerase, RNA-polymerase, DPN-pyrophosphorylase, and nucleoside triphosphatase. The metal ions as  $Ca^{+}$  and  $Mg^{+}$  are supposed to maintain the organization of chromosomes intact.

### **Molecular Structure of Chromosomes**

According to the recent and widely accepted theory of Dupraw (1965, 1970) and Hans Ris (1967) called unistranded theory, each eukaryotic chromosome is composed of a single, greatly elongated and highly folded nucleoprotein fibre of  $100\text{Å}$  thick. This nucleoprotein fibre in its turn is composed of a single, linear, double stranded DNA molecule which remains wrapped in equal amounts of histone and non-histone proteins and variable amounts of different kinds of RNA. Dupraw produced a "folded-fibre Model" to show the ultrastructure of chromosome.

### **FIBRE FOLDED MODEL**

This model shows a highly folded nucleoprotein fibre in a chromosome and also suggests that how the nucleoprotein fibre of a chromosome replicates during cell division and how the nucleoprotein fibre of both chromatids remain held at the centromere by a unreplicated fibre segment to DNA until the anaphase.

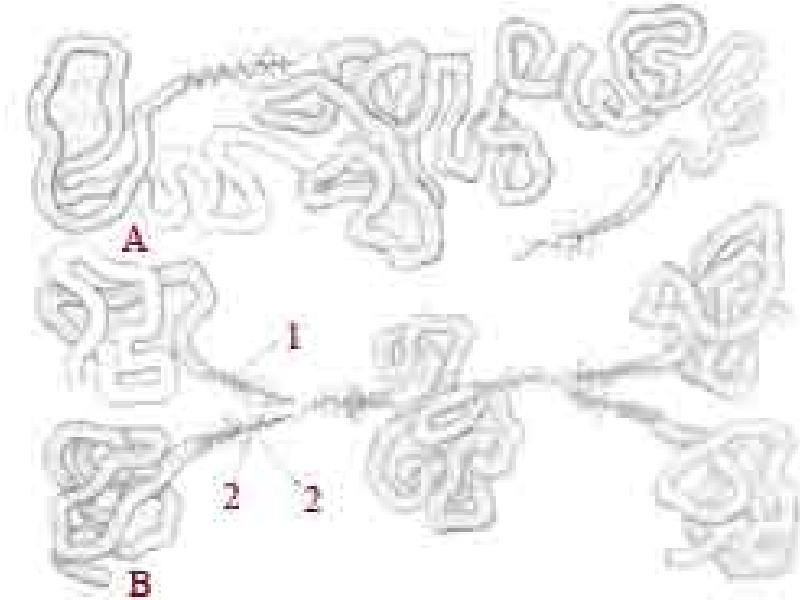

**A-B- The folded fibre model of Dupraw for chromosomes in Interphase**

**1. DNA molecule**

**2. Protein molecules**



**3. Chromatids**

### **Material of Chromosomes**

The chromatin material of the eukaryotic chromosomes according to its percentage of DNA, RNA and proteins and consequently due to its, staining property has been classified into following by classical cytologists:

**1. Euchromatin**

The euchromatin is the extended form of chromatin and it forms the major portion of chromosomes. The euchromatin has special affinity for basic stains and is genetically active because its component DNA molecule synthesizes RNA molecules only in the extended form of chromatin.

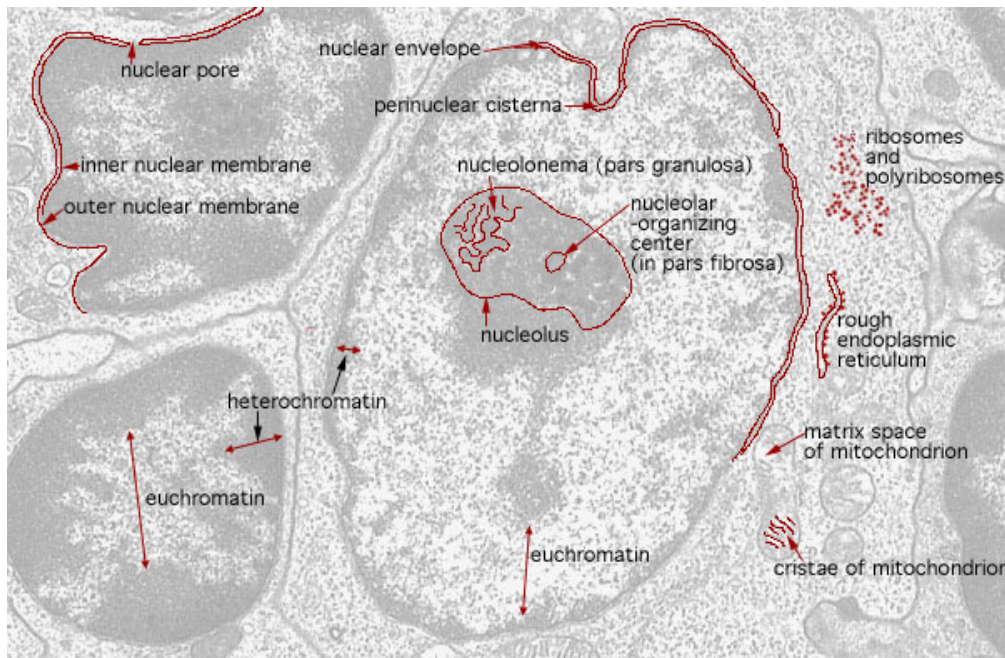

### 2. Heterochromatin

The heterochromatin is a condensed intercoiled state of chromatin, containing two to three times more DNA than euchromatin. However, it is genetically inert as it does not direct synthesis of RNA (i.e., transcription) and protein and is often replicated at a different time from the rest of the DNA.

Recent molecular biological studies have identified three kinds of heterochromatins, namely constitutive, facultative and condensed heterochromatin. The constitutive heterochromatin is present at all times and in the nuclei of virtually all the cells of an organism. In an interphase nucleus, it tends to clump together to form chromocentres or false nucleoli. In *Drosophila*, for example, most pupal, larval and adult cells contain large blocks of constitutive heterochromatin that lie adjacent to centromeres. Constitutive heterochromatin contains highly repetitive satellite DNA which is late replicating, it fails to replicate until late in the S-phase and is then replicated during a brief period just before the G<sub>2</sub>. The facultative heterochromatin reflects the existence of a regulatory device designed to adjust the "dosages" of certain genes in the nucleus.

It is originated during the process called facultative heterochromatization : a process in which a chromosome or a set of chromosome becomes heterochromatic (turned off) in the cells of one sex, while remaining become heterochromatic (turned on) in the cells of opposite sex. In other words, it remains indirectly related to, sexual differentiation. The condensed heterochromatin is deeply staining tightly coiled chromatin which does not resemble with two other kinds of chromatin, has some specific role in gene regulation and is found in many interphase nuclei.

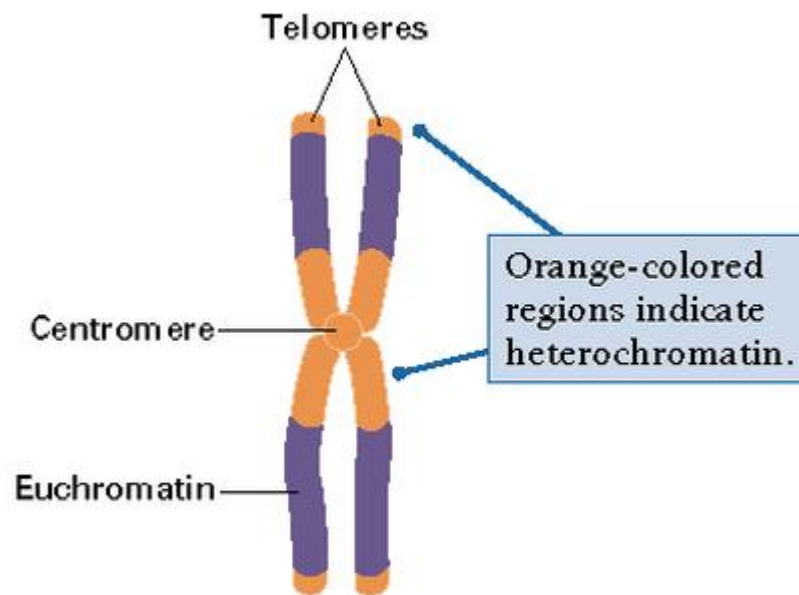

### Kinds of Chromosomes

The eukaryotic chromosomes have been classified into autosomes and sex chromosomes. The autosomes have nothing to do with the determination of sex and exceed in number than sex chromosomes. The sex chromosomes determine the sex of their bearer. They are usually two in number and are usually of two kinds: X chromosomes and Y chromosomes.

### Special Types of Chromosomes

The eukaryotes besides possessing the usual type of chromosomes in their body cells, contain some unusual and special types of chromosomes in some body cells or at some particular stage of their life cycle. The special type of eukaryotic chromosomes are following:

#### Polytene chromosomes

The nuclei of the salivary gland cells of the larvae of dipterans like *Drosophila* have unusually long and wide chromosomes, 100 or 200 times in size of the chromosomes in meiosis and mitosis of the same species. This is particularly surprising, since the salivary gland cells do

not divide after the glands are formed, yet their chromosomes replicate several times (a process called endomitosis) and become exceptionally giant-sized to be called polytene or multistranded chromosomes (discovered by Balbiani (1881) and named by Koller). The endomitosis process result in the production of  $2X$  chromosomes, where  $X$  gives the number of multiplication cycle.

The polytene Chromosomes of the salivary gland cells of *D. melanogaster* contain 1000 to 2000 chromosomes, which are formed by nine or ten consecutive multiplication cycles and remain associated parallel to each other. Further, the polytene chromosomes have alternating dark and light bands along their length. The dark bands are comparable with the chromomeres of a simple chromosomes and are disc-shaped structures occupying the whole diameter of chromosome. They contain euchromatin. The light bands or inter bands are fibrillar and composed of heterochromatin.

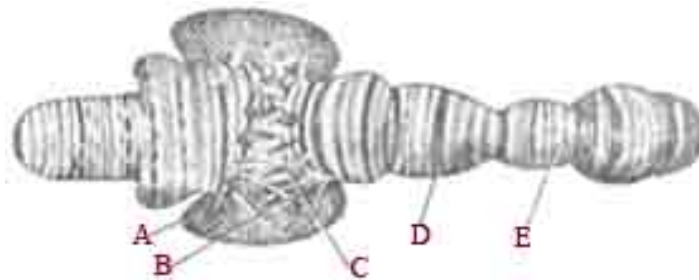

- A. mRNA**
- B. Chromosome puff**
- C. Chromonemata**
- D. Dark band**
- E. Inter band**

If the polytene chromosomes of dipteran larval salivary glands are examined at several stages of development; it is seen that specific areas (sets of bands) enlarge or "puff". Such puffs change location as development proceed, those at specific locations being correlated with particular developmental stages. This temporal puffing indicates changes in gene activity and involves several processes such as the accumulation of acidic proteins, despiralization of DNA, formation of chromonemal loops called Balbiani rings at the lateral sides of dark bands, synthesis of mRNA (messenger RNA) and storage (accumulation) of newly synthesized mRNA around the Balbiani rings.

### **Lampbrush chromosomes**

In diplotene stage of meiosis, the yolk rich oocytes of vertebrates contain the nuclei with many lamp brush shaped chromosomes of exceptionally large sizes. The lampbrush chromosomes (discovered by Ruckert in 1892) are formed during the active synthesis of mRNA

molecules for the future use by the egg during cleavage when no synthesis of mRNA molecules is possible due to active involvement of chromosomes in the mitotic cell division.

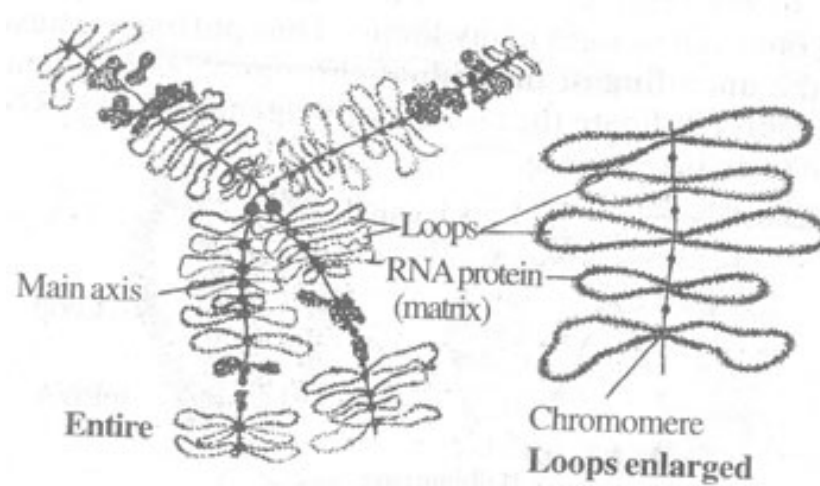

A lampbrush chromosome contains a main axis whose chromonemal fibres (DNA molecule) gives out lateral loops throughout its length. The loops produce the mRNA molecules of different kinds. In a mature egg, as the chromosome contracts the lateral loops disappear.

### **B-chromosomes**

Many plant (maize, etc.) and animal (such as insects and small mammals) species, besides having autosomes (A-chromosomes) and sex-chromosomes possess a special category of chromosomes called B-chromosomes without obvious genetic function. These B-chromosomes (also called supernumerary chromosomes, accessory chromosomes, accessory fragments, etc.) usually have a normal structure, are somewhat smaller than the autosomes and can be predominantly, heterochromatic (many insects, maize, etc. ) or pro-dominantly euchromatic (rye).

In maize, their number per cell can vary from 0 to 30 and they adversely affect, development and fertility only when occur, in large amount. In animals, the B-chromosomes disappear from the non-reproductive (somatic) tissue and are maintained only in the cell-lines that lead to the reproductive organs. B-chromosomes have negative consequences for the organism, as they have deleterious effect because of abnormal crossing over during the meiosis of animals and abnormal nucleus divisions of the gametophyte plants. In animals, B-chromosomes occur more frequently in females and the basis is non-disjunction. The non-

disjunction of B-chromosomes of rye plant is found to be caused due to the presence of a heterochromatic knob at the end of long arm of B-chromosome.

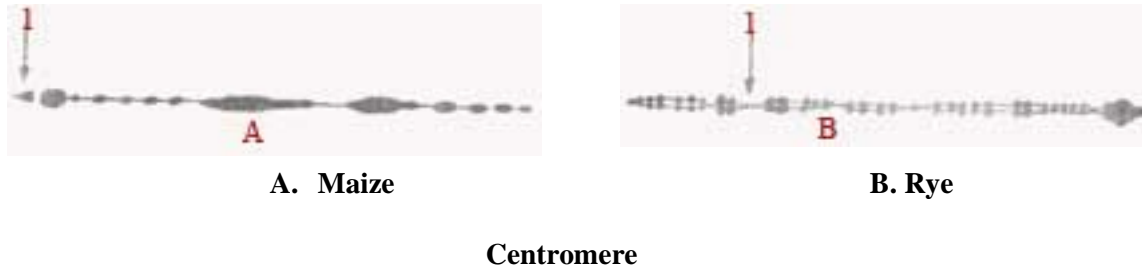

Centromere

The origin of the B-chromosomes is uncertain. In some animals they may be derivatives of sex chromosomes, but this is not the rule. They generally do not show any pairing affinity with the A-chromosomes.

### Holokinetic chromosomes

The chromosomes of most plants and animals have centromeres that are situated at one specific position in each chromosome. In a number of animals, especially in insects of the order Hemiptera and a few, mostly monocotyledonous plants (Juncales, Cyperales), the kinetic activity is distributed over the entire chromosome and such chromosomes are called Holokinetic chromosomes (Sybenga, 1972). The term -diffuse centromere has been used as an alternative but is not quite logical. In mitotic metaphase, the chromatids of a Holokinetic chromosome orient parallel in the equator: one chromatid towards one pole the other towards the other pole. This is also the way they separate in anaphase and they maintain this orientation until they arrive at the poles. Probably kinetic activity starts at one point and proceed from there on, orienting each unit to the preceding one.

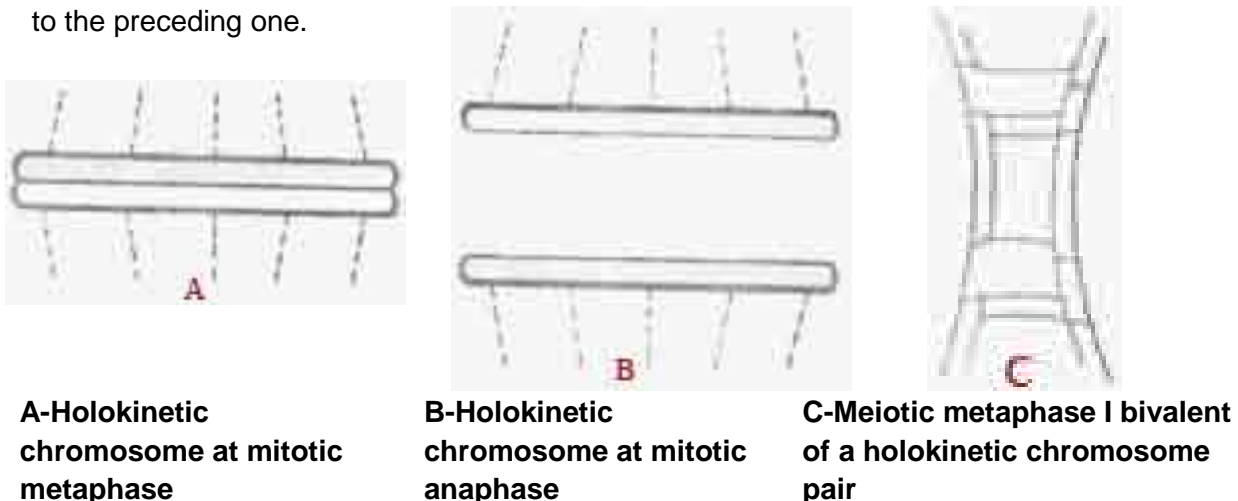

A-Holokinetic chromosome at mitotic metaphase

B-Holokinetic chromosome at mitotic anaphase

C-Meiotic metaphase I bivalent of a holokinetic chromosome pair



In a number of animals, especially in insects of the order Hemiptera and a few, mostly monocotyledonous plants (Juncales, Cyperales), the kinetic activity is distributed over the entire chromosome and such chromosomes are called Holokinetic chromosomes (Sybenga, 1972). The term -diffuse centromere has been used as an alternative but is not quite logical. In 1966 Flach observed this type of centromere in some primitive Dicotyledons (Ranales: Myristica, Ascaris and pseudoscorpion Tityus also possess such polycentric chromosomes. In mitotic metaphase, the chromatids of a Holokinetic chromosome orient parallel in the equator: one chromatid towards one pole the other towards the other pole. This is also the way they separate in anaphase and they maintain this orientation until they arrive at the poles. Probably kinetic activity starts at one point and proceed from there on, orienting each unit to the preceding one.

### **Genetic Significance of Chromosomes**

The chromosomes are considered as the organs of heredity because of following reasons:

- (i) They form the only link between two generations.
- (ii) A diploid chromosome set consists of two morphologically similar (except the X and Y sex chromosomes) sets, one is derived from the mother and another from the father at fertilization.
- (iii) The genetic material, DNA or RNA is localized in the chromosome and its contents are relatively constant from one generation to the next.
- (iv) The chromosomes maintain and replicate the genetic informations contained in their DNA molecule and this information is transcribed at the right time in proper sequence into the specific types of RNA molecules which directs the synthesis of different types of proteins to form a body form like the parents.

### **KARYOTYPE**

A karyotype is the characteristic chromosome complement of a eukaryote species. The preparation and study of karyotypes is part of cytogenetics. The basic number of chromosomes in the somatic cells of an individual or a species is called the somatic number and is designated  $2n$ . Thus, in humans  $2n=46$ . In the germ-line (the sex cells) the chromosome number is  $n$  (humans:  $n=23$ ). So, in normal diploid organisms, autosomal chromosomes are present in two copies. There may, or may not, be sex chromosomes. Polyploid cells have multiple copies of chromosomes and haploid cells have single copies. The study of whole sets of chromosomes is sometimes known as karyology. The chromosomes are depicted (by rearranging a microphotograph) in a standard format known as a karyogram or idiogram: in pairs, ordered by size and position of centromere for chromosomes of the same size. Karyotypes can be used for



many purposes; such as, to study chromosomal aberrations, cellular function, taxonomic relationships, and to gather information about past evolutionary events.

Idiogram

### Staining

The study of karyotypes is made possible by staining. Usually, a suitable dye is applied after cells have been arrested during cell division by a solution of colchicine. For humans, white blood cells are used most frequently because they are easily induced to divide and grow in tissue culture. Sometimes observations may be made on non-dividing (interphase) cells. The sex of an unborn fetus can be determined by observation of interphase cells (see amniotic centesis and Barr body).

Most (but not all) species have a standard karyotype. The normal human karyotypes contain 22 pairs of autosomal chromosomes and one pair of sex chromosomes. Normal karyotypes for females contain two X chromosomes and are denoted 46, XX; males have both an X and a Y chromosome denoted 46,XY. Any variation from the standard karyotype may lead to developmental abnormalities.

Six different characteristics of karyotypes are usually observed and compared:

1. differences in absolute sizes of chromosomes. Chromosomes can vary in absolute size by as much as twenty-fold between genera of the same family: *Lotus tenuis* and *Vicia faba* (legumes), both have six pairs of chromosomes ( $n=6$ ) yet *V. faba* chromosomes are many times larger. This feature probably reflects different amounts of DNA duplication.
2. differences in the position of centromeres. This is brought about by translocations.
3. differences in relative size of chromosomes can only be caused by segmental interchange of unequal lengths.
4. differences in basic number of chromosomes may occur due to successive unequal translocations which finally remove all the essential genetic material from a chromosome, permitting its loss without penalty to the organism (the dislocation hypothesis). Humans have one pair fewer chromosomes than the great apes, but the genes have been mostly translocated (added) to other chromosomes.
5. differences in number and position of satellites, which (when they occur) are small bodies attached to a chromosome by a thin thread.
6. differences in degree and distribution of heterochromatic regions. Heterochromatin stains darker than euchromatin, indicating tighter packing, and mainly consists of genetically inactive repetitive DNA sequences.

A full account of a karyotype may therefore include the number, type, shape and banding of the chromosomes, as well as other cytogenetic information.

Variation is often found:

1. between the sexes
2. between the germ-line and soma (between gametes and the rest of the body)
3. between members of a population (chromosome polymorphism)
4. geographical variation between races
5. mosaics or otherwise abnormal individuals

### **IDEOGRAMS**

Ideograms are a schematic representation of chromosomes. They show the relative size of the chromosomes and their banding patterns. A banding pattern appears when a tightly coiled chromosome is stained with specific chemical solutions and then viewed under a microscope. Some parts of the chromosome are stained (G-bands) while others refuse to adopt the dye (R-bands). The resulting alternating stained parts form a characteristic banding pattern which can be used to identify a chromosome. The bands can also be used to describe the location of genes or interspersed elements on a chromosome.

Below is an ideogram of each human chromosome. Next to the known schematic representation a chromosome was added that was rendered from DNA data. The G-bands, areas with proportional more A-T base pairs, are normally colored black in schematic representations. To compare the schematic ideograms the rendered chromosomes, were colored the A-T bases black and the G-C bases white. Blue areas in the rendered chromosomes identify bases not known yet.

The results are interesting. When comparing the schematic ideograms with the rendered chromosomes from our project, a significant conformancy can be seen. Most black areas on the left side show also black areas on the right side and white areas are also white on the "digital" chromosomes.

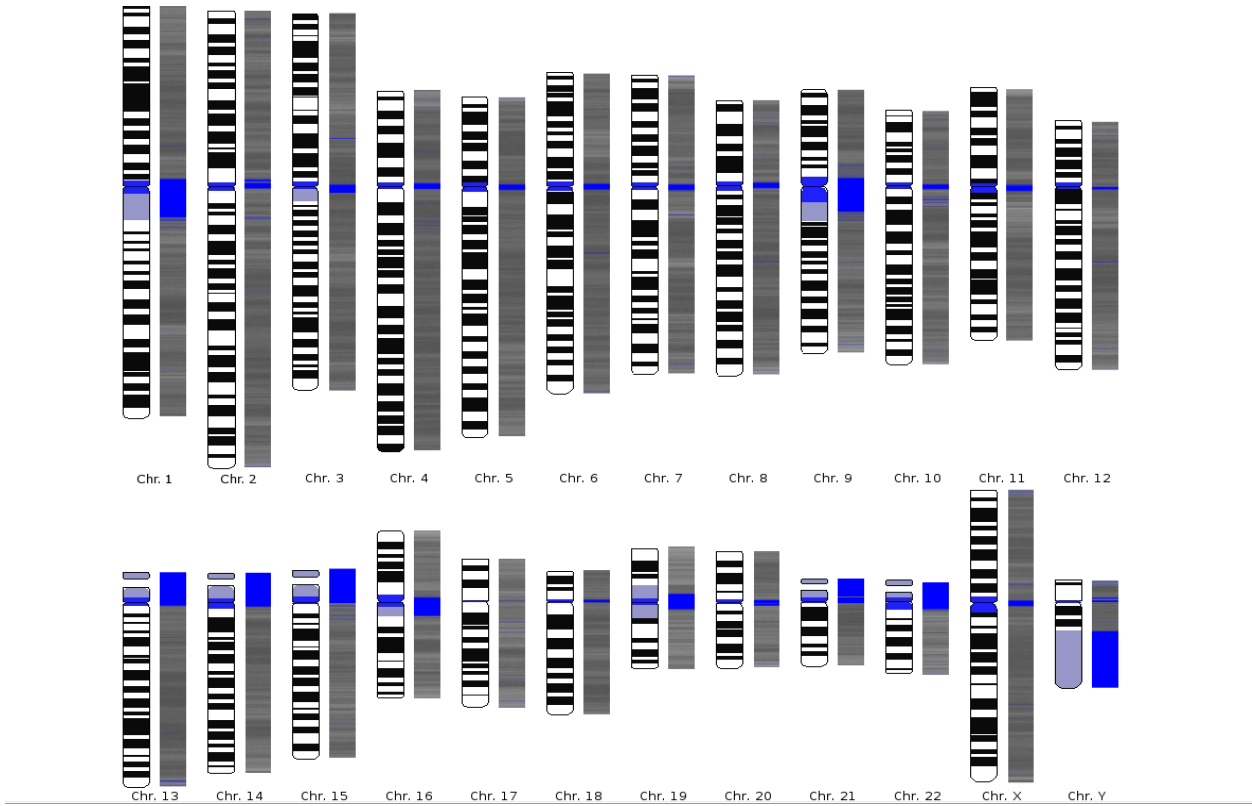

**MITOSIS AND MEIOSIS - THEIR SIGNIFICANCE AND DIFFERENCES BETWEEN THEM**

Mitosis occurs only in eukaryotes. Prokaryotes (i.e., archaea and bacteria) divide via binary fission. Mitosis is the process by which the somatic cells of all multicellular organisms multiply. Somatic cells are the nonreproductive cells of which an organism is composed.

In addition, plants produce gametes by mitosis. Gametes are sexual reproductive cells, that is, there are two types, male and female. In sexual reproduction, a male gamete combines with a female gamete and the resulting, merged cell then divides repeatedly by mitosis to eventually produce a mature organism. Plants also make asexual reproductive cells called spores (by *meiosis*, not mitosis). One spore does not have to combine with another spore for reproduction to occur. A single spore, produced by meiosis, develops into a mature organism by *mitosis*.

**Why mitosis?**

1. Growth. The number of cells within an organism increases by mitosis and this is the basis of growth in multicellular organisms.
2. Cell Replacement. Cells are constantly sloughed off, dying and being replaced by new ones in the skin and digestive tract. When damaged tissues are repaired, the new cells must be exact copies of the cells being replaced so as to retain normal function of cells.
3. Regeneration. Some animals can regenerate parts of the body, and production of new cells are achieved by mitosis.
4. Vegetative Reproduction. Some plants produce offspring which are genetically similar to themselves. These offspring are called **clones**.

**Consequence of mitotic division**

- **No variation** in genetic information
- No variation in chromosome number due to the **semi-conservative replication** of DNA and **equal distribution** of DNA.
- The cell divides **once**.
- Two **identical daughter cells** are formed.

Mitosis produces two daughter cells that are identical to the parent cell. If the parent cell is haploid (N), then the daughter cells will be haploid. If the parent cell is diploid, the daughter cells will also be diploid.

$$N \rightarrow N$$

$$2N \rightarrow 2N$$

## Principles of Genetics

A chromatid is one of the two halves of a replicated chromosome (see diagram at right). The two chromatids that make up a chromosome are called "sister chromatids." They are joined at the centromere and are genetically identical because, during interphase, one sister of each chromatid pair is produced by directly copying the other, pre-existing sister. They therefore contain identical alleles at all loci. In contrast, two homologous chromosomes (chromosomes that have the same set of loci in the same order) usually do not have identical alleles at all loci. They are inherited from different parents and are not direct copies of each other.

The two sister chromatids of each chromosome are segregated into separate cells in both mitosis and meiosis, but they remain together throughout meiosis I. It is only during the second meiotic division (meiosis II) that they finally are separated and distributed into separate cells. As soon as the joined chromatids are separated they are no longer called sisters because they are no longer connected to each other. Instead they are now called unreplicated chromosomes.

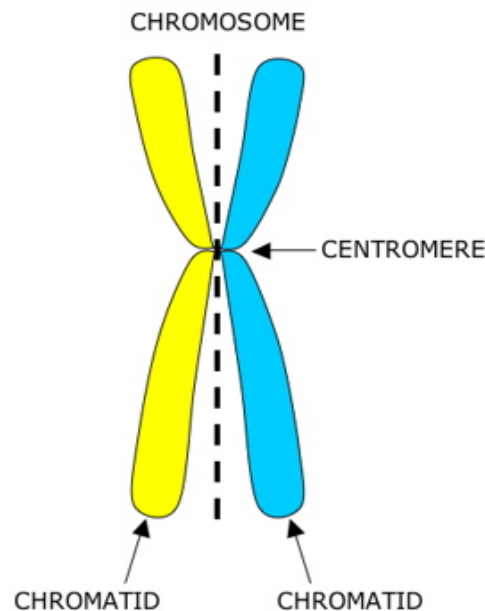

### Stages of Mitosis

The process of mitosis is divided into 6 stages.

- Interphase
- Prophase
- Metaphase
- Anaphase
- Telophase and
- Cytokinesis.

### Interphase

At Interphase, there is only one cell, but after cytokinesis there are two identical cells. Before mitosis can take place, the cell needs to store enough energy to drive the chemical processes during the cell division. During this period of time, there is intense cellular activity. The cell grows in size. The length of the growth phase varies between a few hours to a few months. When the cell has stored enough energy, it is ready to divide itself.

The interphase, or growth, period of the cell cycle alternates with the mitotic phase of the cycle. It's the period when the cell is *not* undergoing mitotic division. So it is *not* part of mitosis. When it begins, the chromosomes (red) have not yet replicated (i.e., each chromosome has a single chromatid), but by the beginning of prophase replication is complete. Thus, the picture shown here represents the chromosomes as they are in the first stage of interphase before replication has occurred, G<sub>1</sub> phase (G<sub>1</sub> stands for first gap). During the next stage, S phase (synthesis), the chromosomes replicate, and by the beginning of the third, G<sub>2</sub> phase (G<sub>2</sub> stands for second gap), replication is complete.

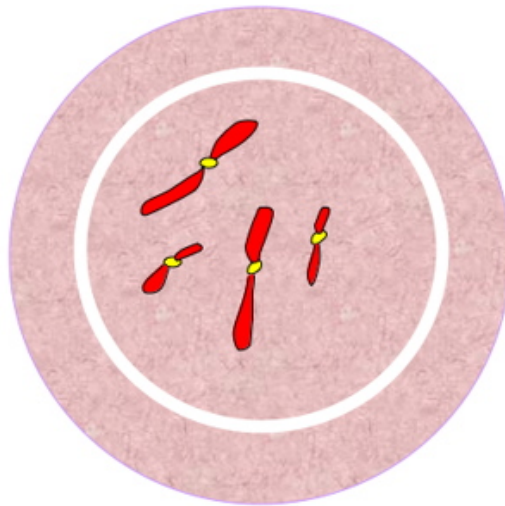

**Parent Cell (Interphase - G<sub>1</sub>)**

In this diagram the chromosomes are shown as if they were visible, simply to show that they have not replicated. However, during G<sub>1</sub>, S, and G<sub>2</sub> they are not actually visible under a light microscope, both because they are uncondensed and because they are still enclosed in the nuclear membrane.

### Prophase

Prophase is the first of the four stages of mitosis. Early during this stage the chromosomes (shown in red in the diagram) become visible with a light microscope as they condense (i.e., as they shorten, coil, and thicken). Also, the spindle (yellow strands) begins to

extend outward from each of two centers of extension. This starlike configuration is called an *aster*. In animal cells one pair of centrioles (represented by the yellow cylinders in the diagram) is present at each center of extension. As prophase progresses, the nuclear membrane (white) begins to break up and disappear. Each chromosome has been duplicated and so is composed of two *sister chromatids* containing identical genetic information.

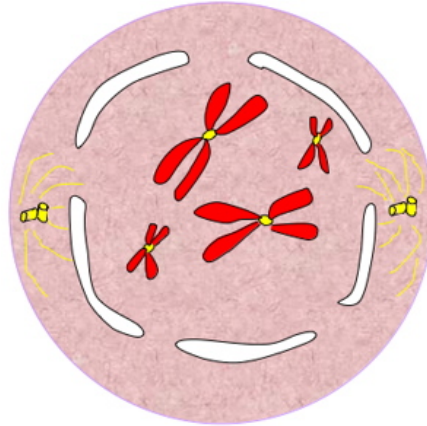

### **METAPHASE**

During this, the second stage of mitosis, the chromosomes line up in the middle of the cell, halfway between the centrioles on an imaginary plane called the "metaphase plate". The spindle fibers (yellow strands) attach to the centromeres (shown as yellow ovals).

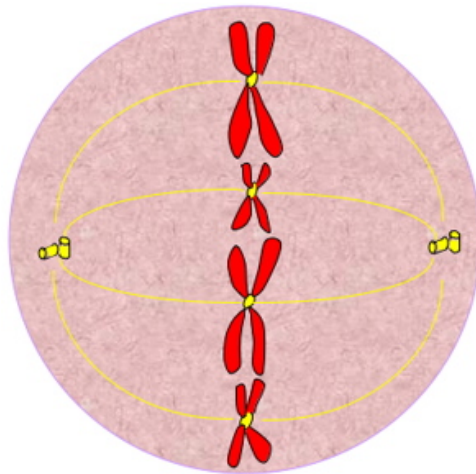

### **ANAPHASE**

During the third of the four stages of mitosis, the two chromatids of each chromosome are pulled apart by the spindle and dragged toward opposite poles of the cell (i.e., toward the opposite centrioles). The arms of each chromosome can be seen dragging behind as the it is dragged along by its centromere.

**Note:** To be called a chromatid, a chromatid must be attached to its sister. When the chromosomes divide at the beginning of anaphase, the sister chromatids are no longer sisters because they are no longer connected. Once they are separated, they are called unreplicated chromosomes. Unreplicated chromosomes will come up again in the Interphase section below.

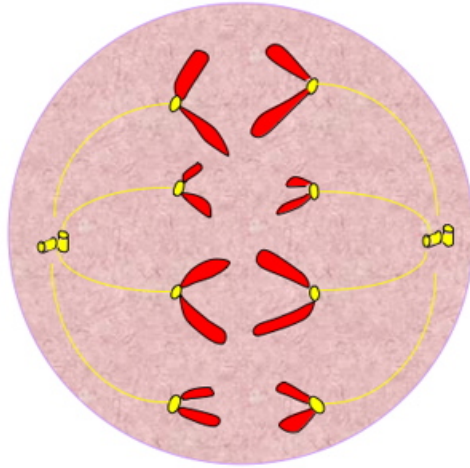

### TELOPHASE

During the last of the four stages of mitosis, telophase, the chromosomes have reached the poles and the nuclear membrane begins to appear. During telophase in animal cells, a cleavage furrow appears (see photo below). By the end of this stage of mitosis, the cell has divided in two along the plane defined by the furrow. In most plants, instead of a cleavage furrow, a "cell plate" forms, dividing the cell into two daughter cells.

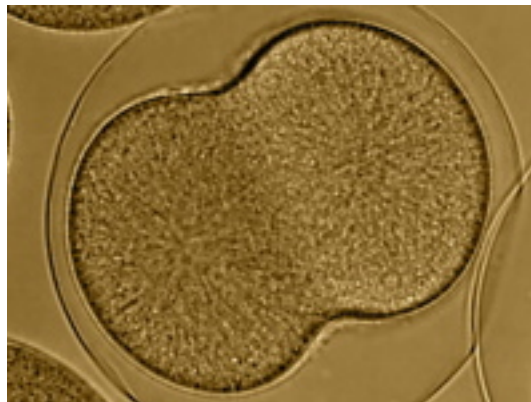



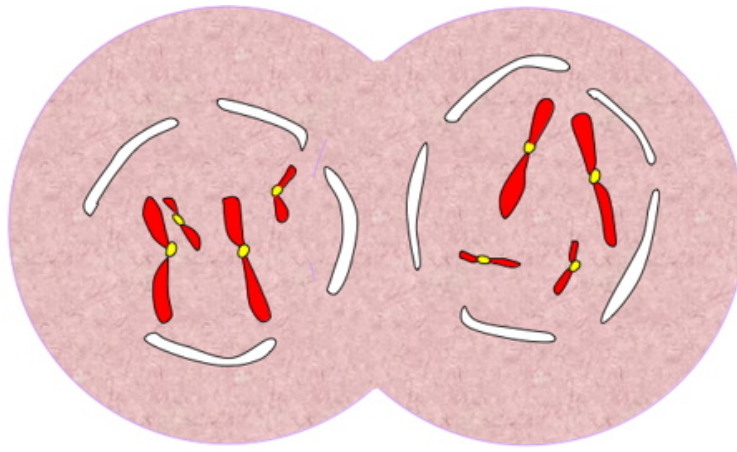

## CYTOKINESIS

While cytokinesis is one of the steps in the cell cycle, it is *not* one of the phases of mitosis. It is the division of the cytoplasm, as opposed to karyokinesis, which is division of the nucleus (the cytoplasm is all of the contents of the cell outside the nucleus). Division of the cytoplasm occurs in both mitosis and meiosis.

After mitosis, the cell returns to interphase, which recall, is the growth stage of the cell cycle between successive mitoses (interphase is the stage during which DNA synthesis, or replication, occurs). Cytokinesis and karyokinesis are now complete and there are two daughter cells. The nuclear membrane has reformed. The chromosomes have decondensed once again and are now re-enclosed in an intact nuclear membrane.

### Significance of mitosis

The significance of mitosis is its ability to produce daughter cells which are exactly the same as the parent cell. It is important for three reasons:

#### 1. Growth

If a tissue wants to get bigger by growth needs new cells that are identical to the existing ones. Cells division must therefore be by mitosis.

#### 2. Repair

Damaged cells have to be replaced by exact copies of the organism so that it repairs the tissues to their former condition. Mitosis is the means by which this is achieved.

#### 3. Asexual reproduction

If a species is good at colonizing a habitat, there might be no point, in producing offspring which are different from the parents, because they might be less effective at survival. Therefore it might be better, in the short term, to make a colony which is similar to the parents. In simple animals and most plants this is achieved by mitotic division.

## MEIOSIS

### When does Meiosis Occur?

Meiosis occurs only in eukaryotes. Meiosis takes place at some point in the life cycle of the typical sexual organism because, by reducing the chromosome number by one half, it compensates for the doubling of the chromosome number caused by fertilization. In animals, meiosis occurs during the production of gametes (sperm and eggs). In plants, it takes place when spores are produced (plant gametes are produced by mitosis). Prokaryotes (i.e., archaea and bacteria) reproduce via binary fission.

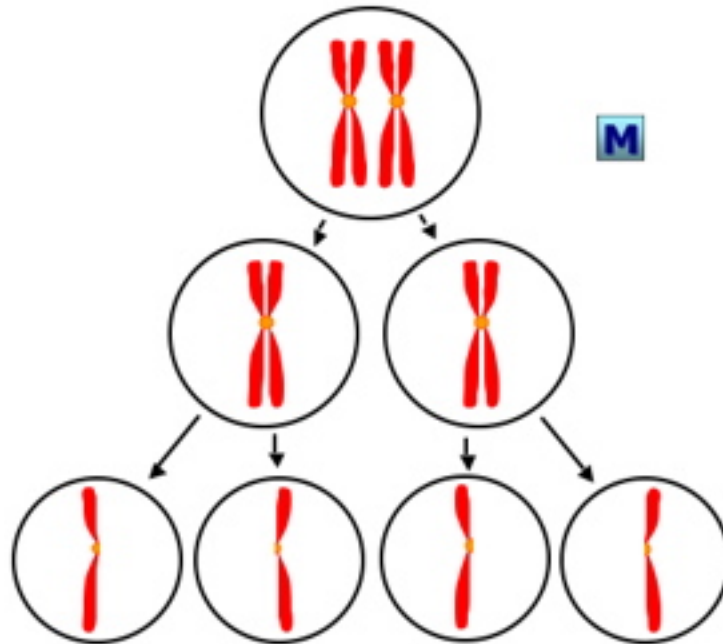

The names of the eight stages of meiosis are: prophase I, metaphase I, anaphase I, telophase I, prophase II, metaphase II, anaphase II, and telophase II. The first four steps (the ones ending in "I") are the phases of the first meiotic division, meiosis I. The last four (those ending in "II") are those of the second meiotic division, meiosis II.

### Prophase I

Prophase I is the first stage of meiosis. During this phase, the chromosomes (shown in red in the diagram, below right) become visible as they shorten, coil, and thicken. Also, the spindle (yellow strands in diagram) begins to extend outward from two centers of expansion. In animal cells a pair of centrioles can be seen in each of these centers (plants lack centrioles). The nuclear membrane (shown in white) breaks up and disappears. Each chromosome is composed of two sister chromatids containing identical genetic information. The information is the same because one sister chromatid is produced by copying the other. The sister chromatids are joined by a centromere (orange).

The two members of each chromosome pair are called *homologous chromosomes* or simply *homologs*. During prophase I they join along their lengths (i.e., they synapse) to form a *tetrad* (or *bivalent*). Each of the two tetrads shown in the drawing, then, is represented as two x-shaped chromosomes aligned along their lengths and connected with each other. This is a simplified diagram, the actual situation is more complicated:

Prophase I is by far the most complicated phase of meiosis. It is much longer in meiosis than in mitosis. During this stage, homologous chromosomes join (synapse) along their lengths and exchange DNA. Prophase I is itself divided into the five substages which are explained and diagrammed below.



### Leptotene

The chromosomes have appeared within the nuclear membrane (shown in the diagram at right as a tan circle with a brown border), but are not yet fully condensed. In the diagram the two chromosomes of paternal origin are indicated in red, those of maternal origin, in blue. Each is a thin thread of DNA (*lepto-* is Greek for *thin* and *-tene* is Greek for ribbon or band) along which clearly defined beads of local coiling (chromomeres) can be seen. The chromosomes, while they have this threadlike form, are called chromatonomata (sing. chromonema; *-nema* is Greek for *thread*). The chromosomes appear single because the sister chromatids are still so tightly bound to each other that they cannot be separately seen. During this stage both ends (telomeres) of each chromosome are turned toward, and probably attached to, the same region of the nuclear membrane. Leptotene is also known as (1) *leptonema*; and as

(2) the *bouquet stage* because all the telomeres tend to contact the nuclear membrane in one spot so that the looped chromosomes balloon out from that point like flower petals.

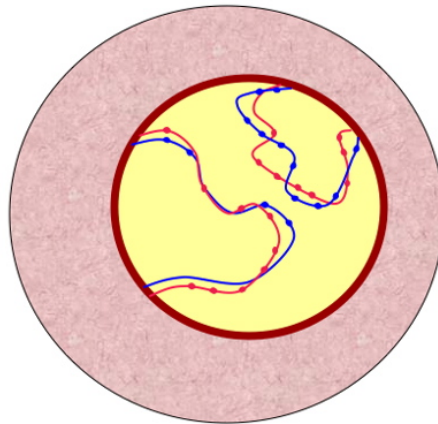

### **Zygotene (also known as zygonema)**

During this stage, homologous chromosomes (or homologs for short) begin to unite (synapse) by coming into approximate alignment (*zygo-* is Greek for *union*, *fusing*, or *yoking*). Synapsis, the process of fusion that occurs between homologous chromosomes, begins at various points along the chromosomes and extends outward, zipper-fashion, until complete. When synapsis is finished, the fused homologous chromosomes look like single chromosomes under the light microscope. These chromosomes that look single, but that are actually double, are called *bivalents*. The interface where two homologous chromosomes ("homologs" for short) unite is called a *synaptonemal complex*, which can be seen under an electron microscope

In the diagram of early zygotene (above right), the regions where the paternal and maternal homologs have fused is shown in purple. In the next diagram, representing late zygotene, both homolog pairs have fused over their entire lengths (so they are shown entirely in purple).

Once the the homolog pairs synapse they are called *tetrads* (each has four chromatids; *tetra* is Greek for *four*) or *bivalents*. *Bivalent* is the preferred term, but *tetrad* is, nonetheless, the word more commonly used in most introductory biology classes. *Bivalent* is the better choice because there are equivalent names for other situations. For example, an unfused homolog is called a univalent. Three fused homologs, a common situation in plants, is called a trivalent, etc.

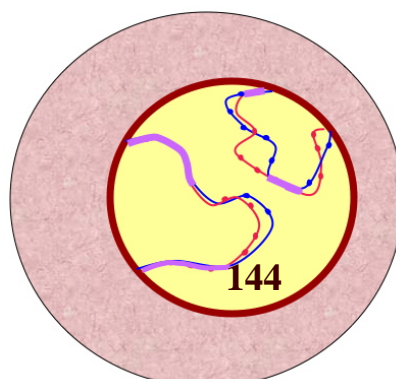

### **Pachytene**

(also known as *pachynema*). During pachytene the two sister chromatids of each chromosome separate from each other. This makes the chromosomes look thicker (*pachy-* is Greek for *thick*). Homologs are still paired at this point. Non-sister chromatids remain in contact throughout pachytene and a kind of localized breakage of the DNA occurs, which is followed by exchanges of DNA between them. This process is called "crossing over." Crossing over produces "cross-over chromatids" each composed of distinct blocks of DNA, some blocks derived from the mother, others from the father.

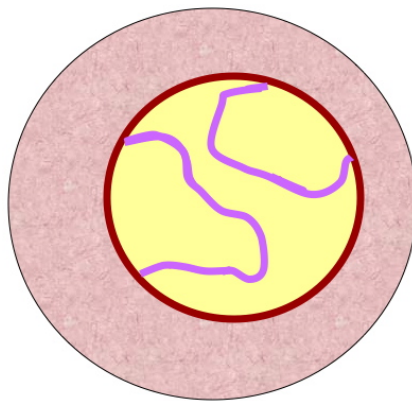

### **Diplotene (also known as *diplonema*)**

At the beginning of this stage each chromatid of each chromosome is still fused to a chromatid of that chromosome/s homolog (recall that sister chromatids are already separate at this point). As diplotene progresses, these initially fused non-sister chromatids begin to separate from each other. However, they cannot separate completely because they are still connected by two strands of DNA at each of the points where exchanges took place. At each cross-over site, the two strands form an x-shaped structure called a chiasma (pl. chiasmata). The chiasmata then begin moving toward the ends of the chromatids. This process of sliding toward the ends is known as *terminalization*.

In oocytes, a special, extremely prolonged form of diplotene occurs called *dictyotene*. The primary oocyte undergoes the first three of the substages of prophase I (leptotene, zygotene, and pachytene) during late fetal life. The process is then suspended during diplotene until puberty or thereafter. Therefore, in oocytes dictyotene (and consequently prophase I) can last months or even years, depending on the type of organism in question.

### Diakinesis

During this, the last stage of Prophase I, the nucleolus disappears, terminalization reaches completion, and the chromosomes coil tightly, and so become shorter and thicker. The nuclear envelope begins to disappear.

(click here to see more details). Note that the two homologs making up a chromosome pair are not expected to be genetically identical, as in the case of sister chromatids, because they are not direct copies of each other and they are inherited from different parents.

When the chromosomes synapse during prophase, each gene in each chromosome is brought into contact with the same gene on that chromosome's homolog. During this process of synapsis, the two homologs of each pair exchange segments of DNA in a process known as *crossing over*. As a result, the gene combinations on each chromosome can be changed. (For example, suppose one homolog initially contained genes for brown eyes and brown hair. After crossing over, it could contain genes for *blue* eyes and brown hair, where the gene for blue eyes was taken from its homolog.

While prophase I is proceeding, the spindle's two centers of expansion move to the opposite ends of the cell (i.e., to the "poles") and the spindle lengthens and extends toward the "metaphase plate," an imaginary plane defining the middle plane of the cell, halfway between the centriole pairs. The tetrads also move toward the metaphase plate.

### METAPHASE I

In the second phase of the first meiotic division, metaphase I, the tetrads align on the "metaphase plate," halfway between the poles of the cell. Next, the spindle fibers attach to the centromeres of each chromosome. Both spindle fiber attachment points (kinetochores) of each sister chromatid pair are turned toward the same pole. As a result, both kinetochores attach to spindle fibers from the *same* pole. This is a major difference between meiosis and mitosis. It causes the two members of each chromosome pair to be separated from each other during the next stage of meiosis, anaphase I (in mitotic metaphase, the two kinetochores of each sister chromatid pair attach to spindle fibers from *opposite* poles, so each chromatid separates from its sister during anaphase).

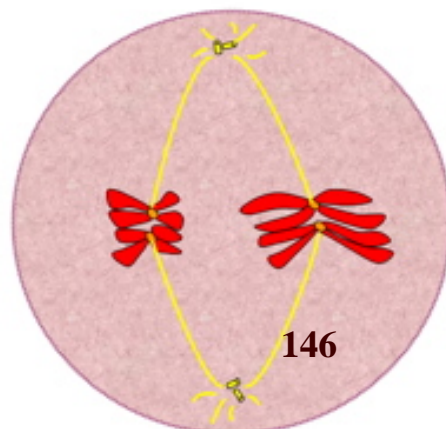



### ANAPHASE I

In the third stage, anaphase I, the cell lengthens as it begins the process of division. Homologs of each chromosome pair move toward opposite poles, drawn by the microtubules of the spindle apparatus (this contrasts with mitosis, where the sister chromatids from each homolog separate and move toward opposite poles).

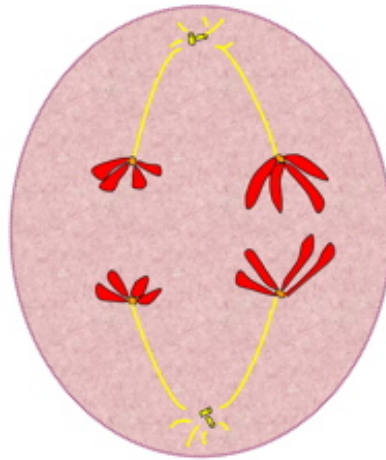

### TELOPHASE I

In this, the fourth stage of meiosis, the chromosomes reach the poles. At each pole, now, there is a complete haploid set of chromosomes (but each chromosome still has two sister chromatids). During telophase I, a cleavage furrow appears. By the end of this stage the cell has divided in two along the plane defined by the furrow. This separation of the cytoplasm is called cytokinesis. In some organisms the nuclear membrane reappears briefly at this point (this intermediate stage is called interkinesis), but in others the daughter cells begin immediately to prepare for the second meiotic division.

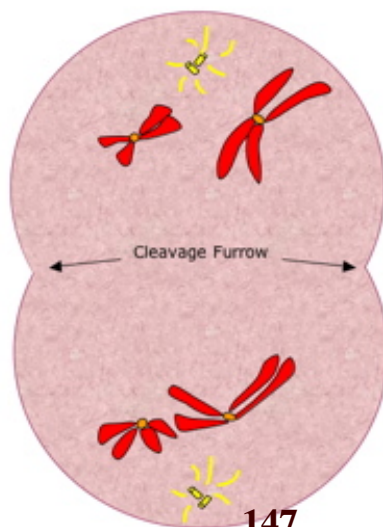

## **CYTOKINESIS**

Cytokinesis is not one of the stages or phases of meiosis or mitosis. It is the process of division that the cytoplasm undergoes when it is distributed into daughter cells (as opposed to karyokinesis, which is division of the nucleus). The cytoplasm is all of the contents of the cell other than the nucleus. The cytoplasm lies outside the nucleus and is bounded by the plasma membrane. The liquid portion of cytoplasm is called cytosol.

## **Interkinesis**

In many organisms, after meiosis I, the daughter cells begin immediately to prepare for the second meiotic division. In others, however, the nuclear membrane reappears between telophase I and prophase II, and there is a period of rest. This period, during which the membrane is again visible, is called interkinesis. Each chromosome is still composed of two chromatids.

## **PROPHASE II**

Prophase II begins with the two daughter cells produced by the first meiotic division. As in Prophase I, the chromosomes are condensed and not yet attached to the spindle apparatus. If there was an interkinesis, then the nuclear membranes begin to break down again during this stage. The centrioles have replicated and are moving toward the poles.



## **METAPHASE II**

In metaphase II the chromosomes move to the equator ("metaphase plate") of each of the two daughter cells produced by the first meiotic division. This time, unlike metaphase I, the two kinetochores of each centromere attach to spindle fibers from opposite poles



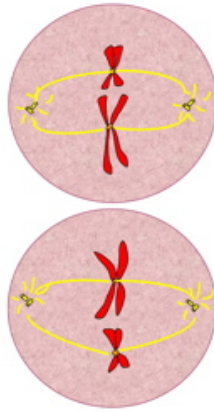

### ANAPHASE II

During the seventh stage of meiosis, anaphase II (the third stage of the second division), the sister chromatids of each chromosome separate and move toward opposite poles.

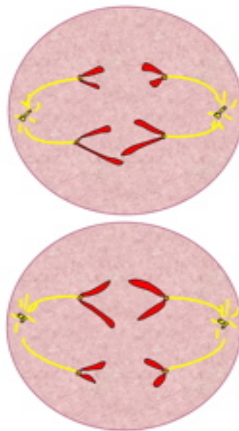

### TELOPHASE II

During telophase II, the sister chromatids reach opposite poles, cytokinesis occurs, the two cells produced by meiosis I divide to form four haploid daughter cells, and the nuclear membranes (white in the diagram) reform.

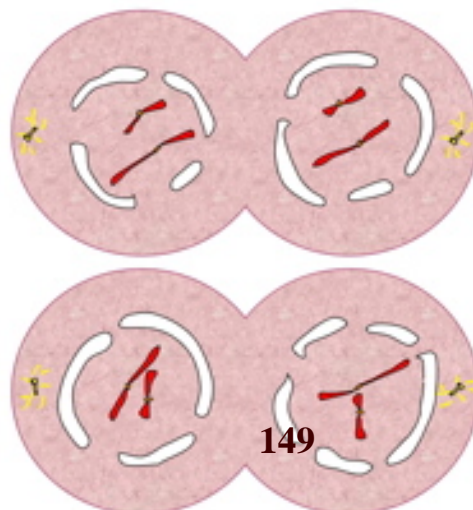

### Significance of Meiosis

The long term survival of a species depends on its ability to adapt to a changing environment. To do this the offspring need to be different from their parents and each other. These are three ways in which variety occurs because of meiosis.

#### a. Production and fusion of haploid gametes

The variety of offspring is increased by mixing the genotype of one parent with that of the other. It involves the production of special sex cells, called gametes, which fuse together to produce a new organism. Each gamete contains half the number of chromosomes of the adult. It is important that meiosis, which halves the number of chromosomes in daughter cells, happens at some stage in the life cycle of a sexually reproducing organism. Therefore Meiosis is important in order for variety in organisms, and allowing them to evolve.

#### b. The creation of genetic variety by the random distribution of chromosomes during metaphase 1

When the pairs of homologous chromosomes arrange themselves on the equator of the spindle during metaphase 1 of meiosis, they do it randomly. Even though each one of the pair determines the same general features, they're detail of the feature is different. The randomness of this distribution and independent assortment of these chromosomes produces new genetic combinations.

#### c. The creation of genetic variety by crossing over between homologous chromosomes

During prophase 1 of meiosis, equal portions of homologous chromosomes may be swapped. In this way new genetic combinations are made and linked genes separated. The variety which meiosis brings vital for to the process of evolution. By providing a varied stock of individuals it allows the natural selection of those best suited to the existing conditions and makes sure that species constantly change and adapt when these conditions change. This is the main biological significance of meiosis.

	<b>Meiosis</b>	<b>Mitosis</b>
<b>Definition</b>	A type of cellular reproduction in which the number of chromosomes are reduced by half through the separation of homologous chromosomes in a diploid cell.	A process of asexual reproduction in which the cell divides in two producing a replica (exact copy) with an equal number of chromosomes (One cell becomes two)

<b>Function</b>	Growth, Repair, asexual Reproduction	Cellular Reproduction (cell division during which the cell nucleus divides)
<b>Type of Reproduction</b>	Sexual	Asexual
<b>Discovered by</b>	Oscar Hertwig	Walther Flemming
<b>Creates</b>	Sex cells only	Makes everything other than sex cells (Somatic Cells)
<b>Occurs in</b>	Humans, animals, plants	all organisms
<b>Produces</b>	four haploid daughter cells	two diploid daughter cells
<b>Genetically</b>	different	identical
<b>Steps</b>	Proceded by Interphase	Proceded by Interphase
<b>Chromosome Number</b>	Reduced by half (homologous pairs seperate)	Remains the same
<b>Number of Divisions</b>	2 nuclear and cytoplasmic divisions	1 division of the nucleus in Cytokinesis

## **DNA AND IT' S STRUCTURE, FUNCTION, TYPES, MODES OF REPLICATION AND REPAIR**

The discovery that DNA is the prime genetic molecule, carrying all the hereditary information within chromosomes, immediately had its attention focused on its structure. It was hoped that knowledge of the structure would reveal how DNA carries the genetic messages that are replicated when chromosomes divide to produce two identical copies of themselves. During the late 1940s and early 1950s, several research groups in the United States and in Europe engaged in serious efforts—both cooperative and rival—to understand how the atoms of DNA are linked together by covalent bonds and how the resulting molecules are arranged in three-dimensional space. Not surprisingly, it was feared that DNA might have very complicated and perhaps bizarre structures that differed radically from one gene to another. Great relief, if not general elation, was thus expressed when the fundamental DNA structure was found to be the double helix. It told us that all genes have roughly the same three-dimensional form and that the differences between two genes reside in the order and number of their four nucleotide building blocks along the complementary strands.

### **What is DNA?**

The work of many scientists paved the way for the exploration of DNA. Way back in 1868, almost a century before the Nobel Prize was awarded to Watson, Crick and Wilkins, a young Swiss physician named Friedrich Miescher, isolated something no one had ever seen before from the nuclei of cells. He called the compound "nuclein." This is today called nucleic acid, the "NA" in DNA (deoxyribo-nucleic-acid) and RNA (ribo-nucleic-acid).

Two years earlier, the Czech monk Gregor Mendel, had finished a series of experiments with peas. His observations turned out to be closely connected to the finding of nuclein. Mendel was able to show that certain traits in the peas, such as their shape or colour, were inherited in different packages. These packages are what we now call genes.

For a long time the connection between nucleic acid and genes was not known. But in 1944 the American scientist Oswald Avery managed to transfer the ability to cause disease from one strain of bacteria to another.

But not only that: the previously harmless bacteria could also pass the trait along to the next generation. What Avery had moved was nucleic acid. This proved that genes were made up of nucleic acid.

### **Solving the Puzzle**

In the late 1940's, the members of the scientific community were aware that DNA was most likely the molecule of life, even though many were skeptical since it was so "simple". They also knew that DNA included different amounts of the four bases adenine, thymine, guanine and cytosine (usually abbreviated A, T, G and C), but nobody had the slightest idea of what the molecule might look like.

In order to solve the elusive structure of DNA, a couple of distinct pieces of information needed to be put together. One was that the phosphate backbone was on the outside with bases on the inside; another that the molecule was a double helix. It was also important to figure out that the two strands run in opposite directions and that the molecule had a specific base pairing.

### **Watson and Crick**

In 1951, the then 23-year old biologist James Watson travelled from the United States to work with Francis Crick, an English physicist at the University of Cambridge. Crick was already using the process of X-ray crystallography to study the structure of protein molecules. Together, Watson and Crick used X-ray crystallography data, produced by Rosalind Franklin and Maurice Wilkins at King's College in London, to decipher DNA's structure.

This is what they already knew from the work of many scientists, about the DNA molecule:

1. DNA is made up of subunits which scientists called nucleotides.
2. Each nucleotide is made up of a sugar, a phosphate and a base.
3. There are 4 different bases in a DNA molecule:
  - adenine (a purine)
  - cytosine (a pyrimidine)
  - guanine (a purine)
  - thymine (a pyrimidine)
4. The number of purine bases equals the number of pyrimidine bases
5. The number of adenine bases equals the number of thymine bases

6. The number of guanine bases equals the number of cytosine bases
7. The basic structure of the DNA molecule is helical, with the bases being stacked on top of each other

### Components of DNA

DNA is a polymer. The monomer units of DNA are nucleotides, and the polymer is known as a "polynucleotide". Each nucleotide consists of a 5-carbon sugar (deoxyribose), a nitrogen containing base attached to the sugar, and a phosphate group. There are four different types of nucleotides found in DNA, differing only in the nitrogenous base. The four nucleotides are given one letter abbreviations as shorthand for the four bases.

- A is for adenine
- G is for guanine
- C is for cytosine
- T is for thymine

### Purine Bases

Adenine and guanine are purines. Purines are the larger of the two types of bases found in DNA. Structures are shown below:

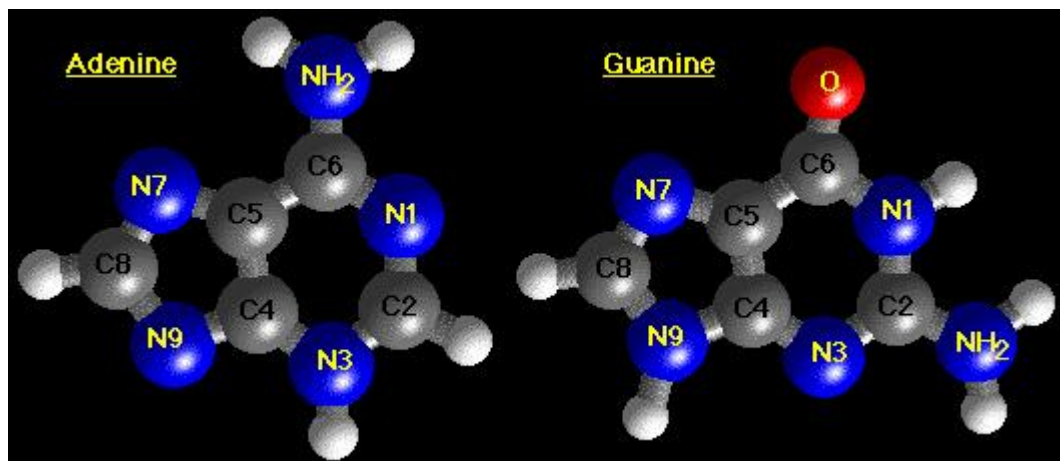

The 9 atoms that make up the fused rings (5 carbon, 4 nitrogen) are numbered 1-9. All ring atoms lie in the same plane.

### Pyrimidine Bases

Cytosine and thymine are pyrimidines. The 6 atoms (4 carbon, 2 nitrogen) are numbered 1-6. Like purines, all pyrimidine ring atoms lie in the same plane.

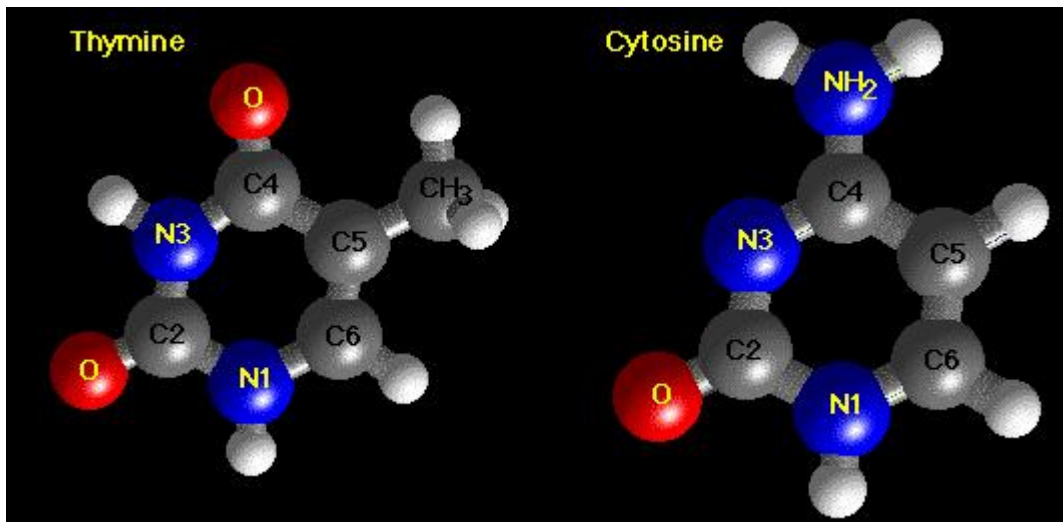

### Deoxyribose Sugar

The deoxyribose sugar of the DNA backbone has 5 carbons and 3 oxygens. The carbon atoms are numbered 1', 2', 3', 4', and 5' to distinguish from the numbering of the atoms of the purine and pyrimidine rings. The hydroxyl groups on the 5'- and 3'- carbons link to the phosphate groups to form the DNA backbone. Deoxyribose lacks an hydroxyl group at the 2'-position when compared to ribose, the sugar component of RNA.

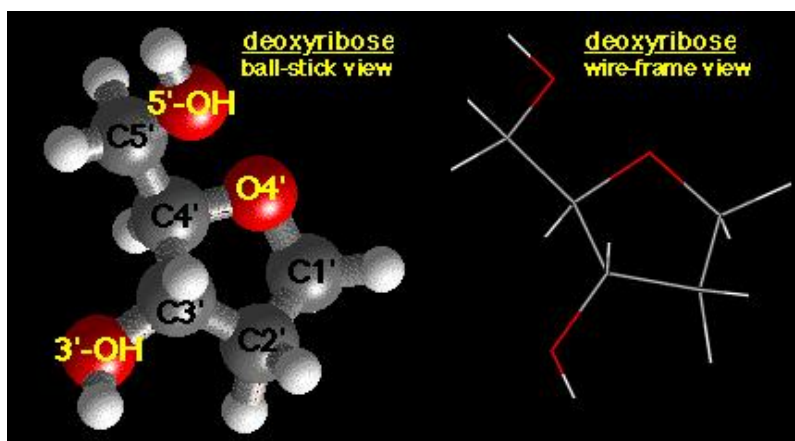

### Nucleosides

A nucleoside is one of the four DNA bases covalently attached to the C1' position of a sugar. The sugar in deoxynucleosides is 2'-deoxyribose. The sugar in ribonucleosides is ribose. Nucleosides differ from nucleotides in that they lack phosphate groups. The four different nucleosides of DNA are deoxyadenosine (dA), deoxyguanosine (dG), deoxycytosine (dC), and (deoxy)thymidine (dT, or T).



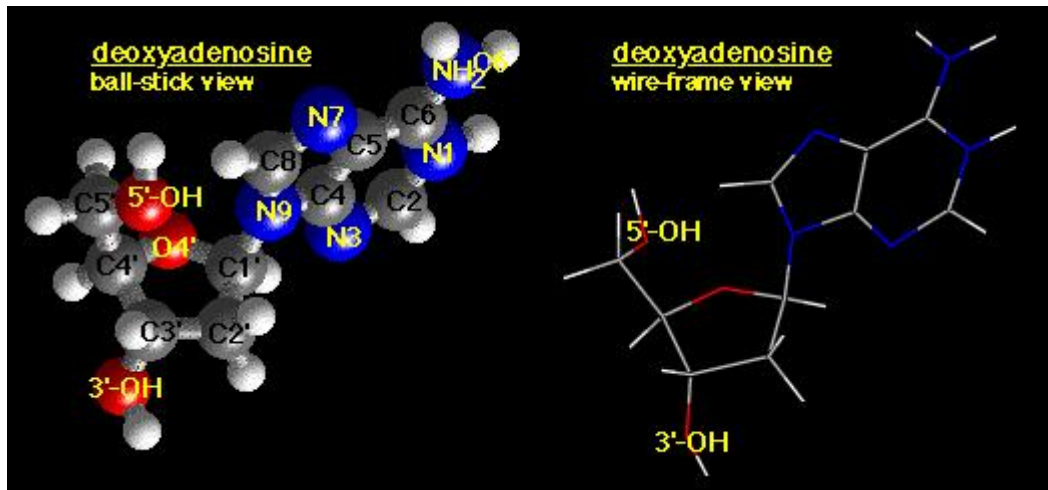

In dA and dG, there is an "N-glycoside" bond between the sugar C1' and N9 of the purine.

### Nucleotides

A nucleotide is a nucleoside with one or more phosphate groups covalently attached to the 3'- and/or 5'-hydroxyl group(s).

### DNA Backbone

The DNA backbone is a polymer with an alternating sugar-phosphate sequence. The deoxyribose sugars are joined at both the 3'-hydroxyl and 5'-hydroxyl groups to phosphate groups in ester links, also known as "phosphodiester" bonds.

### Example of DNA Backbone: 5'-d (CGAAT)

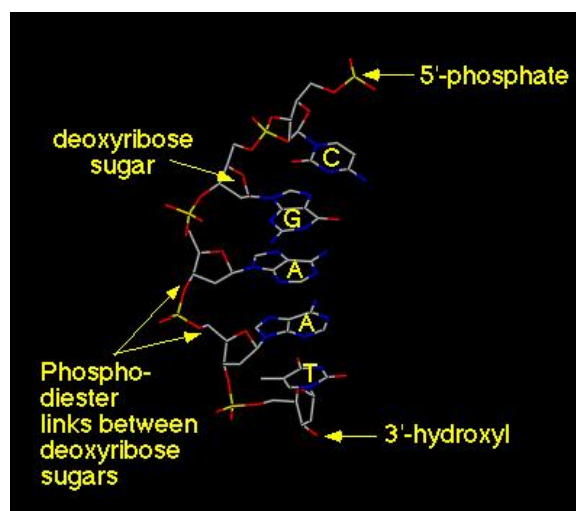

### Features of the 5'-d(CGAAT) structure:

- Alternating backbone of deoxyribose and phosphodiester groups



- Chain has a direction (known as polarity), 5'- to 3'- from top to bottom
- Oxygens (red atoms) of phosphates are polar and negatively charged
- A, G, C, and T bases can extend away from chain, and stack atop each other
- Bases are hydrophobic

### DNA Double Helix

DNA is a normally double stranded macromolecule. Two polynucleotide chains, held together by weak thermodynamic forces, form a DNA molecule.

### Structure of DNA Double Helix

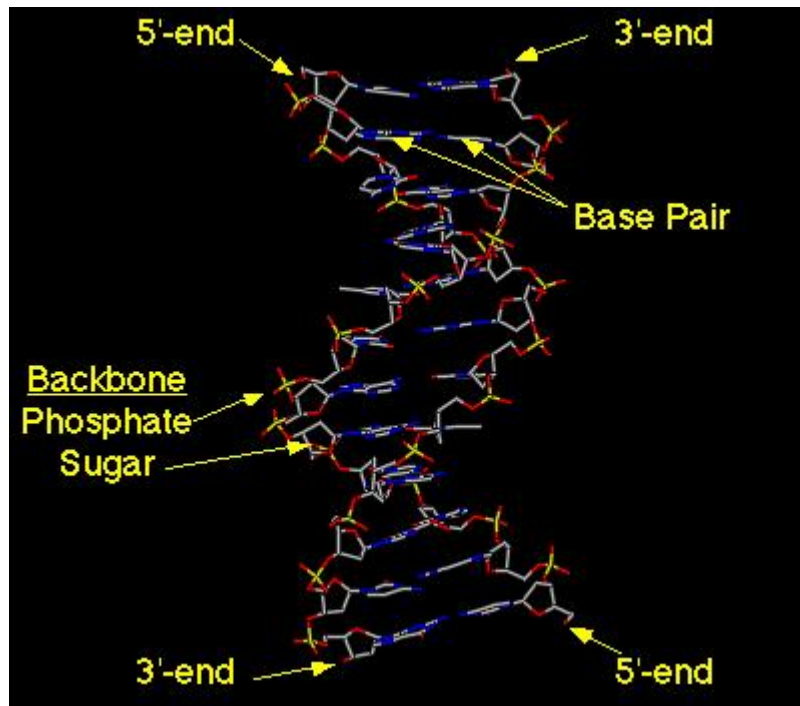

### Features of the DNA Double Helix

- Two DNA strands form a helical spiral, winding around a helix axis in a right-handed spiral
- The two polynucleotide chains run in opposite directions
- The sugar-phosphate backbones of the two DNA strands wind around the helix axis like the railing of a spiral staircase

- The bases of the individual nucleotides are on the inside of the helix, stacked on top of each other like the steps of a spiral staircase.

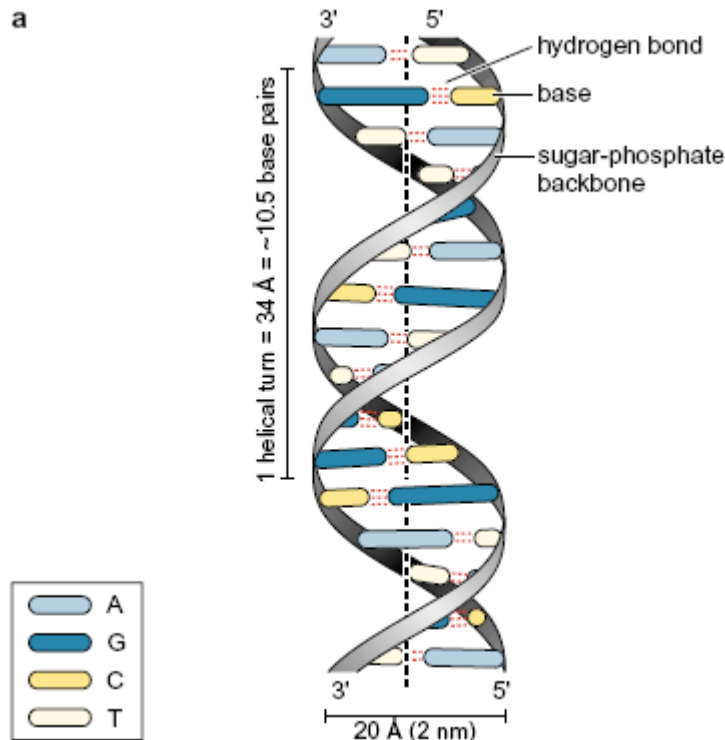

### The Double Helix

The double helix of DNA has these features:

- It contains two polynucleotide strands wound around each other.
- The backbone of each consists of alternating deoxyribose and phosphate groups.
- The phosphate group bonded to the 5' carbon atom of one deoxyribose is covalently bonded to the 3' carbon of the next.
- The two strands are "antiparallel"; that is, one strand runs 5' to 3' while the other runs 3' to 5'.
- The DNA strands are assembled in the 5' to 3' direction and, by convention, we "read" them the same way.
- The purine or pyrimidine attached to each deoxyribose projects in toward the axis of the helix.
- Each base forms hydrogen bonds with the one directly opposite it, forming **base pairs** (also called nucleotide pairs).

- 3.4 Å separate the planes in which adjacent base pairs are located.
- The double helix makes a complete turn in just over 10 nucleotide pairs, so each turn takes a little more (35.7 Å to be exact) than the 34 Å shown in the diagram.
- There is an average of 25 hydrogen bonds within each complete turn of the double helix providing a stability of binding about as strong as what a covalent bond would provide.
- The diameter of the helix is 20 Å.
- The helix can be virtually any length; when fully stretched, some DNA molecules are as much as 5 cm (2 inches!) long.
- The path taken by the two backbones forms a major (wider) groove (from "34 Å" to the top of the arrow) and a minor (narrower) groove (the one below).

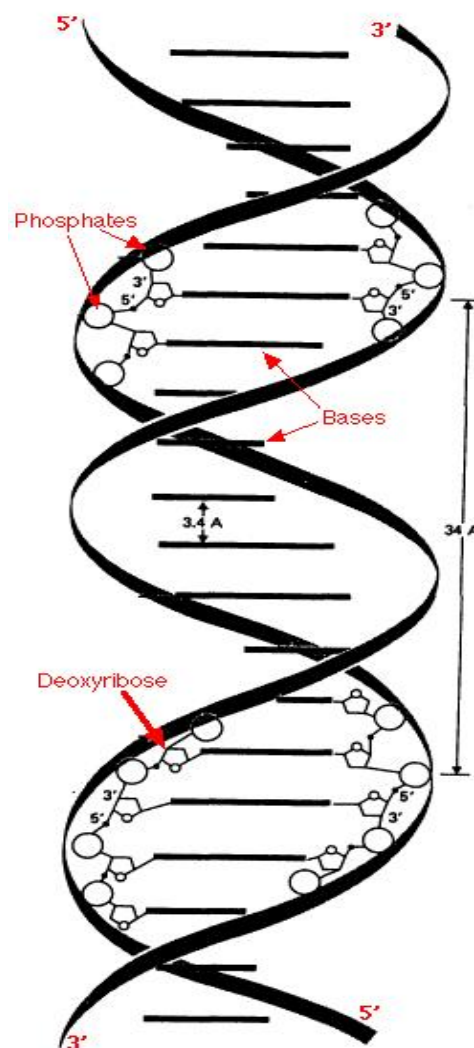

Nucleic acids (DNA and RNA) are the polymers i.e. long chain compounds. The molecular structure of DNA has two aspects

- 1) its chemical sub units and
- 2) the way in which these chemical sub units are arranged to form a long chain molecule.

The second aspect is very significant as the accepted DNA model should be such that it explains biochemically the various aspects (function) of a gene such as stability to metabolic and external agents, the capacity for replication (self duplication) the capacity to store vast hereditary information in coded form and the capacity to express the phenotypes they control.

### **FUNCTIONS OF DNA**

DNA carries the genetic information of a cell and consists of thousands of genes. Each gene serves as a recipe on how to build a protein molecule. Proteins perform important tasks for the cell functions or serve as building blocks. The flow of information from the genes determines the protein composition and thereby the functions of the cell.

The DNA is situated in the nucleus, organized into chromosomes. Every cell must contain the genetic information and the DNA is therefore duplicated before a cell divides (**replication**). When proteins are needed, the corresponding genes are transcribed into RNA (**transcription**). The RNA is first processed so that non-coding parts are removed (**processing**) and is then transported out of the nucleus (**transport**). Outside the nucleus, the proteins are built based upon the code in the RNA (**translation**).

### **Types of DNA**

DNA can be classified in various ways based on 1. number of base pair per turn. 2. coiling pattern, 3. location 4. structure, 5. nucleotide sequence and 6. number of strands.

**1. Number of base per turn.** Depending upon the nucleotide base per turn of the helix, tilt of the base pair and humidity of the sample, the DNA can be observed in four different forms namely A,B, C and D.

**2. Coiling pattern.** On the basis of coiling pattern of the helix DNA is of two types viz right handed and left handed. Most of the DNA molecules are right handed i.e. coiling of helix is in the right direction. It is also

called positive coiling. All the four forms of DNA viz A, B, C and D are right handed. The Z DNA has left handed double helical structure. This DNA is considered to be associated with gene regulation.

**3. Location.** Based on the location in the cell DNA is of three types. Viz., chromosomal DNA cytoplasm DNA and promiscuous DNA. Chromosomal DNA is found in chromosomes. And are called as chromosomal DNA or nuclear DNA. Cytoplasmic DNA is found in the cytoplasm especially in mitochondria and chloroplasts. Such DNA plays an important role in cytoplasmic inheritance and has circular structure. Promiscuous DNA. Some DNA segments with common base sequence are found in the chloroplasts, mitochondria and nucleus. This suggests that some DNA sequences move from one organelle to other. Such DNA is referred to as promiscuous DNA.

**4. Structure of RNA:** It contains ribose sugar, nitrogen bases and phosphate group. The nitrogen bases include adenine, guanine, cytosine and uracil. In DNA thymine is present in place of uracil and deoxyribose sugar is found in place of ribose sugar. In RNA, the pairing occurs between adenine and uracil. It has usually single strand. However, some viruses have double stranded RNA.

The DNA molecule that Watson and Crick described was in the B form. It is now known that DNA can exist in several other forms. The primary difference between the forms is the direction that the helix spirals.

A, B, C = right-handed helix Z = left-handed helix (found in vitro under high salt)

B is the major form that is found in the cell. Z-DNA was initially found only under high salt conditions, but the cellular environment is actually a low-salt environment. The question then is whether type Z exist under cellular conditions. Several features have been discovered that can stabilize Z-DNA under in a low salt environment.

**Differences between DNA and RNA**

S. No	Particulars	DNA	RNA
1.	Strands	Usually two, rarely one	Usually one, rarely two
2.	Sugar	Deoxyribose	Ribose

3.	Base	Adenine guanine cytosine and thymine	Adenine guanines cytosine
4.	Pairing	AT and GC	AU and GC
5.	Location	Mostly in chromosomes some in mitochondria and chloroplasts	In chromosomes and ribosomes

### MODES OF REPLICATION

There are three possible modes of DNA replication:

- (1) Dispersive
- (2) Conservative
- (3) Semiconservative

1. **In dispersive replication**, the old DNA molecule would break into several pieces, each fragment would replicate and the old and new segments would recombine randomly to yield progeny DNA molecules. Each progeny molecule would have both old and new segments along its length.

2. According to the **conservative scheme**, the two newly synthesized strands ( following the replication of a DNA molecule) would associate to form one double helix, while the two old strands would remain together as one double helix.

3. In contrast, in the **semi conservative mode** of DNA replication, each newly synthesized strand would remain associated with the old strand against which it was synthesized. Thus each progeny DNA molecule would consist of one old and one newly synthesized strand.

#### Semi Conservative Replication

The semi conservative mode of DNA replication was postulated by Watson and Crick along with the double helix model of DNA. The main features of this mode of DNA replication are as follows:

1. A progressive separation of the two strands of a DNA molecule.
2. Complementary base pairing of the bases located in the single stranded regions thus produced with the appropriate free deoxyribonulceotides.

3. Formation of phosphodiester linkages between the neighbouring deoxyribonucleotides that have base paired with the single stranded regions, thereby producing regions the new strand.
4. This ensures that the base sequence of the new strands are strictly complementary to those of the old strands.
5. The base sequence of a newly synthesized strand is dictated by the base sequence of the old strand, since the old strand serves as a template or mould for the synthesis of the new strand.

### **DNA Replication**

It is proposed by Watson and Crick. According to this method, both the strands of parental DNA separate from one another. Each old strand synthesizes a new strand. Thus, each of the two resulting DNA has one parental and one new strand. This method of DNA replication is universally accepted because there are several evidences in support of semi conservative method and it consists of several steps.

**1. Initiation of Replication** DNA replication starts at a specific point on the chromosome. This unique site is known as origin. The site of initiation differs from organism to organism. Sometime replication starts with an incision made by an incision enzyme known as endonuclease.

**2. Unwinding of strands.** The two stands of DNA double helix unwind. The opening of DNA stands take's places with the help of DNA unwinding protein.

**3. Formation of RNA Primer.** Synthesis of RNA primer is essential for initiation of DNA synthesis RNA primer is synthesized by the DNA template near the origin with the help of a special type of RNA polymerase.

**4. Synthesis of DNA on primer.** After formation of RNA primer, DNA synthesis starts on the RNA primer. Deoxyribose nucleotides are added to the 3e end position of RNA primer. The main DNA strand is synthesized on the DNA template with help of DNA polymerase. The DNA synthesis takes place in short pieces. Which are known as Okazaki fragments.

**5. Removal of RNA Primer:** DNA polymerase degrades the RNA primer  
1. This enzyme also catalyzes the synthesis of short DNA segment to replace the prime. The newly synthesized segment is joined to the main DNA strand with the help of DNA ligase enzyme.

**6. Union of Okazaki Fragments.** The discontinuous fragment of Okazaki is joined to make continuous strands. The union of Okazaki fragments takes place with the help of a joining enzyme called polynucleotide ligase. The replication may take place either in one direction or in both the directions from the point of origin.

#### **Evidence for semi conservation replication**

Various experiments have demonstrated the semi-conservative mode of DNA replication. Now it is universally accepted that DNA replicates in a semi-conservative manner. There are three important experiments, which support that DNA replication is semi-conservative. These include (1) Meselson and Stahl experiment (2) Cairns experiment and (3) Taylor's experiment.

**Taylor's experiment:** Taylor (1969) conducted his experiments with root tip cells of *vicia faba*. He treated root tips with radioactive thymidine to label the DNA. The root tips were grown in the normal medium. In the first generation both chromatids were labeled. In the second generation of cell division, one chromatid of each chromosome was labeled and the other one was normal. This demonstrated semi conservative mode of chromosome replication. The DNA replication is associated with chromosome replication.

#### **Enzymes involved in DNA / RNA replication**

DNA replication involves several proteins and enzymes, which together form the multi-enzymes complex, replication apparatus or replisome. In *E. coli* at least two dozen gene products are involved in DNA replication. Many of these proteins were first identified through studies of mutants e.g. Genes *dna E*, *dna N*, *dna X* etc of *E. coli* code for the four of the seven polypeptides of the complete DNA polymerase III enzyme, and *DNA G* specifies the primase enzyme. Some enzymes like ligase, DNA polymerase I etc were discovered biochemically.

#### **DNA repair systems**

Damages to the genetic material, i.e., DNA are taken care of by the DNA repair systems. The various damages to DNA may be grouped into the following two types:

**(1) Single base changes:** Such changes affect a single base of a DNA molecule they do not produce structural distortions and do not affect



either replication or transcription of the affected molecules. These changes are represented by the conversion of one base into another, eg; deamination of 5-methylcytosine results in thymine and by the covalent addition of a small group to a base which affects its pairing behavior. As a result, the affected base does not pair properly with its partner base.

**(2) Structural distortions:** These changes generally adversely affect the replication and or transcription of the affected DNA molecule. They are represented by a single strand nick, removal of a base, covalent links between bases in the same or in the opposite strands (eg) Pyrimidine dimers and addition of a bulky adduct to a base which may distort the configuration of the double helix.

The repair systems recognize a variety of changes in DNA to initiate action. Each cell possesses several repair systems in order to be able to deal with the various types of DNA damage; these systems may be grouped into the following general categories

1. Direct repair
2. Excision repair
3. Mismatch repair
4. Tolerance systems
5. Retrieval systems

### **1. Direct repair of DNA**

The reversal or simple removal of the damage to the DNA is known as direct repair, eg., removal of the covalent bonds between the two 4 and two 5 carbons of the two thymine residues participating in the formation of thymine dimers. Thymine dimers are generally formed due to UV radiation and interfere with replication and transcription. A specific enzyme mediates the splitting of the covalent bonds between the two T residues, which specifically recognizes thymine dimers. The enzyme can bind to the thymine dimers in the dark, but requires the energy from blue light for removal of the covalent bonds between the T residues; that is why this process is known as photoreactivation. The direct repair system is wide spread in nature and is especially important in plants.

### **2. Excision repair**

In this repair pathway, the damaged or mispaired segment of the DNA strand is excised and new stretch of DNA is synthesized in its

place. The various excision repair systems vary in their specificity. The repair process consists of the following steps:

**a. Recognition and incision:** The damaged section of a strand recognized by an endonuclease; this enzyme then cuts the affected strand on both the sides of damage.

**b. Excision:** After the incision, a 5' to 3' exonuclease digests away the damage/ mispaired section; this generates a single stranded region in the DNA double helix.

**c. Synthesis:** In this step, the single stranded region produced by excision serves as a template for a DNA polymerase which synthesizes the replacement for the excised segment. DNA ligase then seals the nick that remains after the synthesis of the replacement for the excised section.

**3. Mismatch repair:** When single bases in the DNA are mismatched, either due to alterations in the existing bases or due to errors during replication, structural distortions result in the DNA double helix.

**4. Tolerance systems:** These systems deal with the damages that block normal replication at the damaged sites possibly by permitting the replication of the damaged sites possibly with a high frequency of errors. These systems may be particularly important in the eukaryotes where the genome size is very large and hence a complete repair of the damage is rather unlikely.

**5. Retrieval systems:** These systems are also known as post replication repair or recombination repair.

**RNA AND ITS STRUCTURE, FUNCTION AND TYPES**

With the discovery of the molecular structure of the DNA double helix in 1953, researchers turned to the structure of ribonucleic acid (RNA) as the next critical puzzle to be solved on the road to understanding the molecular basis of life. Ribonucleic acid (RNA) is a type of molecule that consists of a long chain of nucleotide units. Each nucleotide consists of a nitrogenous base, a ribose sugar, and a phosphate. RNA is very similar to DNA, but differs in a few important structural details: in the cell, RNA is usually single-stranded, while DNA is usually double-stranded; RNA nucleotides contain ribose while DNA contains deoxyribose (a type of ribose that lacks one oxygen atom); and RNA has the base uracil rather than thymine that is present in DNA.

RNA is transcribed from DNA by enzymes called RNA polymerases and is generally further processed by other enzymes. RNA is central to the synthesis of proteins. Here, a type of RNA called messenger RNA carries information from DNA to structures called ribosomes. These ribosomes are made from proteins and ribosomal RNAs, which come together to form a molecular machine that can read messenger RNAs and translate the information they carry into proteins. There are many RNAs with other roles – in particular regulating which genes are expressed, but also as the genomes of most viruses.

**Ribose Nucleic Acids**

Most cellular RNA is single stranded, although some viruses have double stranded RNA. The single RNA strand is folded upon itself, either entirely or in certain regions. In the folded region a majority of the bases are complementary and are joined by hydrogen bonds. This helps in the stability of the molecule. In the unfolded region the bases have no complements. Because of this RNA does not have the purine, pyrimidine equality that is found in DNA.

RNA also differs from DNA in having ribose as the sugar instead of deoxyribose. The common nitrogenous bases of RNA are adenine, guanine, cytosine and uracil. Thus the pyrimidine uracil substitutes thymine of DNA. In regions where purine pyrimidine pairing takes place, adenine pairs with uracil and guanine with

cytosine. In addition to the four bases mentioned above, RNA also has some unusual bases.

### CHEMICAL STRUCTURE OF RNA

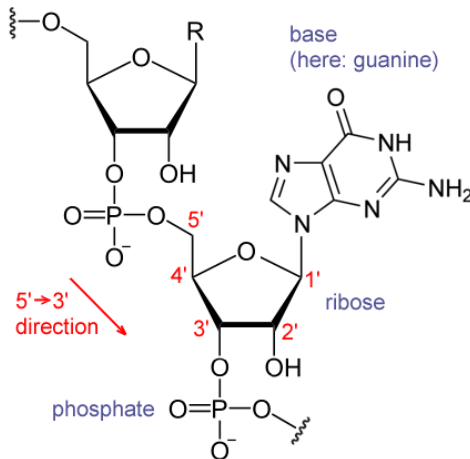

An important structural feature of RNA that distinguishes it from DNA is the presence of a hydroxyl group at the 2' position of the ribose sugar. The presence of this functional group causes the helix to adopt the A-form geometry rather than the B-form most commonly observed in DNA. This results in a very deep and narrow major groove and a shallow and wide minor groove. A second consequence of the presence of the 2'-hydroxyl group is that in conformationally flexible regions of an RNA molecule (that is, not involved in formation of a double helix), it can chemically attack the adjacent phosphodiester bond to cleave the backbone.

Most cellular RNA molecules are single stranded. They may form secondary structures such as stem-loop and hairpin.

**Secondary structure of RNA. (a) stem-loop. (b) hairpin.**

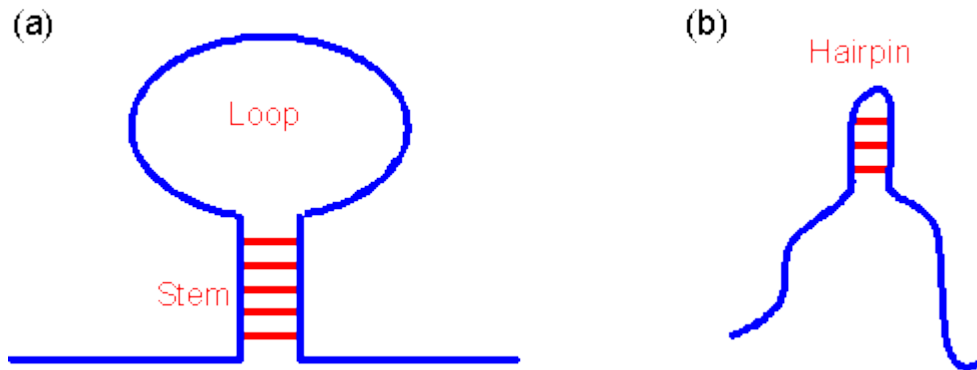

There are more unusual bases in RNA than in DNA. All normal RNA chains either start with adenine or guanine: Three types of cellular RNA have been distinguished:

**Messenger RNA (mRNA) or template RNA**

**Ribosomal RNA (rRNA) and**

**Soluble RNA (sRNA) or transfer RNA (tRNA)**

Ribosomal and transfer RNA comprise about 98% of all RNA. All three forms of RNA are made on a DNA template.

Transfer RNA and messenger RNA are synthesized on DNA templates of the chromosomes, while ribosomal RNA is derived from nucleolar DNA. The three types of RNA are synthesized during different stages in early development. Most of the RNA synthesized during cleavage is mRNA. Synthesis of tRNA occurs at the end or cleavage, and rRNA synthesis begins during gastrulation.

**Comparison between DNA and RNA**

	<b>DNA</b>	<b>RNA</b>
1.	DNA is the usual genetic material	RNA is the genetic material of some viruses.
2.	DNA is usually double-stranded, (In certain viruses DNA is single stranded, e.g. $\phi$ X 174).	Most cellular RNA is single stranded. (Some viruses e.g. retrovirus, have double stranded RNA).
3.	The pentose sugar is deoxyribose.	The pentose sugar is ribose.

4.	The common organic bases are adenine, guanine, cytosine and thymine.	The common organic bases are adenine, guanine, cytosine and uracil.
5.	Base pairing: adenine pairs with thymine and guanine with cytosine.	Adenine pairs with uracil and guanine with cytosine.
6.	Pairing of bases is throughout the length of the molecule.	Pairing of bases is only in the helical region
7.	There are fewer uncommon bases	There are more uncommon bases.
8.	DNA is only of one type	There are three types of RNA messenger, ribosomal and transfer RNA.
9.	Most of the DNA is found in the chromosomes. Some DNA is also found in the cytoplasm e.g. in mitochondria and chloroplasts.	Messenger RNA is formed on the chromosomes, and is found in the nucleolus and cytoplasm. rRNA and tRNA are also formed on the chromosomes, and are found in cytoplasm.
10.	Denaturation (melting) is partially reversible only under certain conditions of slow cooling (renaturation).	Complete and practically instantaneous reversibility of the process of melting.
11.	Sharp, narrow temperature interval of transition in melting.	Broad temperature interval of transition in melting.
12.	DNA on replication forms DNA, and on transcription forms RNA.	Usually RNA does not replicate or transcribe. (In certain viruses RNA can synthesize an RNA chain).
13.	Genetic messages are usually encoded in DNA.	The usual function of RNA is translating messages encoded in DNA into proteins.
14.	DNA consists of a large number of nucleotides, up to 4.3 million	RNA consists of fewer nucleotides, up to 12,000.

### Ribosomal RNA – rRNA

Ribosomal RNA, as the name suggests, is found in the ribosomes. It comprises about 80% of the total RNA of the cell. The base sequence of rRNA is complementary to that of the region of DNA where it is synthesized.

In eukaryotes ribosomes are formed on the nucleolus. Ribosomal RNA is formed from only a small section of the DNA molecule, and hence there is no definite base relationship between rRNA and DNA as a whole.

Ribosomal RNA consists of a single strand twisted upon itself in some regions. It has helical regions connected by intervening single strand regions. The helical regions may show presence or absence of positive interaction. In the helical region most of the base pairs are complementary, and are joined by hydrogen bonds. In the unfolded single strand regions the bases have no complements.

Ribosomal RNA contains the four major RNA bases with a slight degree of methylation, and shows differences in the relative proportions of the bases between species. Its molecules appear to be single polynucleotide strands which are unbranched and flexible. At low ionic strength rRNA behaves as a random coil, but with increasing ionic strength the molecule shows helical regions produced by base pairing between adenine and uracil and guanine and cytosine.

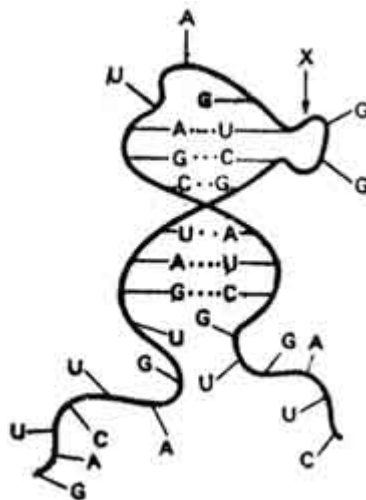

Hence rRNA does not show purine-pyrimidine equality. The rRNA strands unfold upon heating and refold upon cooling. Ribosomal RNA is stable for at least two generations. The ribosome consists of proteins and RNA. The 70S ribosome of

prokaryotes consists of a 30S subunit and a 50S subunit. The 30S subunit contains 16S rRNA, while the 50S subunit contains 23S and 5S rRNA.

The 80S eukaryote ribosome consists of a 40S and a 60S subunit. In vertebrates the 40S subunit contains 18S rRNA, while the 60S subunit contains 28-29S, 5.8S and 5S rRNA. In plants and invertebrates the 40S subunit contains 16-18S RNA, while the 60S subunit contains 25S and 58 and 5.8S rRNA. There are three types of ribosomal RNA on the basis of sedimentation and molecular weight.

Two of these classes are high molecular weight RNAs, while the third is a low molecular weight RNA. The three classes are: (1) high molecular weight rRNA with molecular weight of over a million, e.g. 21s-29s RNA, (2) high molecular weight rRNA with molecular weight below a million e. g. 12-8-188 rRNA, (3) low molecular weight rRNA e. g. 58 rRNA.

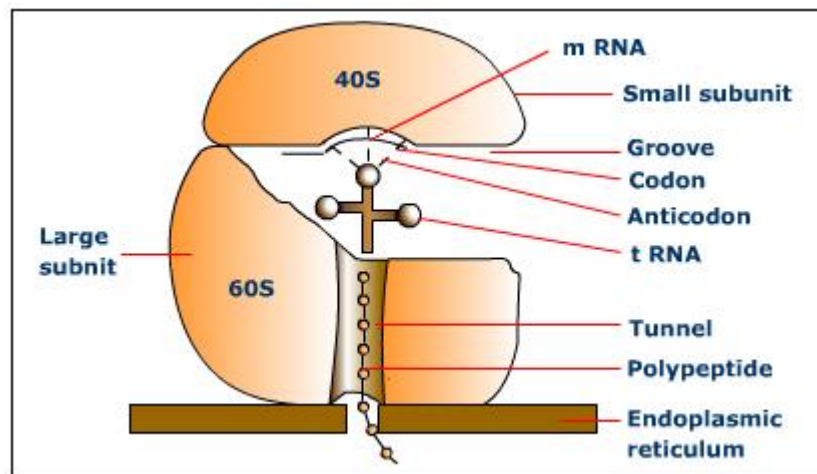

**Messenger RNA - mRNA** - Jacob and Monod (1961) proposed the name messenger RNA for the RNA carrying information for protein synthesis from the DNA (genes) to the sites of protein formation (ribosomes). It consists of only 3 to 5% of the total cellular RNA.

**Size of Messenger RNA - mRNA** - The molecular weight of an average sized mRNA molecule is about 500,000, and its sedimentation coefficient is 8S. It should be noted however, that mRNA varies greatly in length and molecular weight. Since most proteins contain at least a hundred amino acid residues, mRNA must have at least  $100 \times 3 = 300$  nucleotides on the basis of the triplet code.



**Stability of Messenger RNA - mRNA** - The cell does not contain large quantities of mRNA. This is because mRNA, unlike other RNAs is constantly undergoing breakdown. It is broken down to its constituent ribonucleotides by ribonucleases.

### **Structure of Messenger RNA - mRNA**

Messenger RNA is always single stranded. It contains mostly the bases adenine, guanine, cytosine and uracil. There are few unusual substituted bases. Although there is a certain amount of random coiling in extracted mRNA, there is no base pairing. In fact base pairing in the mRNA strand destroys its biological activity

Since mRNA is transcribed on DNA (genes), its base sequence is complementary to that of the segment of DNA on which it is transcribed. This has been demonstrated by hybridization experiments in which artificial RNA, DNA double strands are produced. Hybridization takes place only if the DNA and RNA strands are complementary.

Usually each gene transcribes its own mRNA. Therefore, there are approximately as many types of mRNA molecules as there are genes. There may be 1,000 to 10,000 different species of mRNA in a cell. These mRNA types differ only in the sequence of their bases and in length.

When one gene (cistron) codes for a single mRNA strand the mRNA is said to be monocistronic. In many cases, however, several adjacent cistrons may transcribe an mRNA molecule, which is then said to be polycistronic or polygenic.

The mRNA molecule has the following structural features:

**1. Cap.** At the 5' end of the mRNA molecule in most eukaryote cells and animal virus molecules is found a 'cap'. This is blocked methylated structure, m<sup>7</sup>Gpp Nmp Np or m<sup>7</sup>Gpp Nmp Nmp Np. where: N = any of the four nucleotides and Nmp = 20 methyl ribose. The rate of protein synthesis depends upon the presence of the cap. Without the cap mRNA molecules bind very poorly to the ribosomes.

**2. Noncoding region 1 (NC1).** The cap is followed by a region of 10 to 100 nucleotides. This region is rich in A and U residues, and does not translate protein.

**3. The initiation codon** is AUG in both prokaryotes and eukaryotes

**4. The coding region** consists of about 1,500 nucleotides on the average and translates protein It is made up of 73-93 nucleotides (Rich and RajBhandary,

1976). Each bacterial cell probably contains about a hundred or more different types of tRNA. The function of tRNA is to carry amino acids to mRNA during protein synthesis. Each amino acid is carried by a specific tRNA. Since 20 amino acids are coded to form proteins, it follows that there must be at least 20 types of tRNA.

It was formerly thought that only 20 tRNA molecular types exist, one for each amino acid. It has, however, been shown that in several cases there are at least two types of tRNA for each amino acid. Thus there are many more tRNA molecules than amino acid types. These are probably coded by one gene.

Transfer RNA is synthesized in the nucleus on a DNA template. Only 0.025% of DNA codes for tRNA. Synthesis of tRNA occurs near the end of cleavage stages. Transfer RNA is an exception to other cellular RNAs in that a part of its ribonucleotide sequence (-CCA) is added after it comes off the DNA template. Like rRNA, tRNA is also formed from only a small section of the DNA molecule.

Therefore, it does not show any obvious base relationships to DNA. The tRNA molecule consists of a single strand looped about it self. The 3' end always terminates in a -C-C-A (cytosine- cytosine-adenine) sequence. The 5' end terminates in G (guanine) or C (cytosine). Many of the bases are bonded to each other, but there are also unpaired bases.

### **Transfer RNA - tRNA OR Soluble RNA – sRNA**

After rRNA the second most common RNA in the cell is transfer RNA. It is also called soluble RNA because it is too small to be precipitated by ultracentrifugation at 100,000 g. It constitutes about 10-20% of the total RNA of the cell. Transfer RNA is a relatively small RNA having a molecular weight of about 25,000 to 30,000 and the sedimentation coefficient of mature eukaryote tRNA is 3.8S.

### **Structure of Transfer RNA – tRNA**

The nucleotide sequence (primary structure) of tRNA was first worked out by Holley et al (1965) for yeast alanine tRNA. Since then the sequence of about 75 different tRNAs, ranging from bacteria to mammals, has been established. The different tRNAs are all minor variants of the same basic type of structure.

Several models of the secondary structure of tRNA have been proposed, and of these the cloverleaf model of Holley is the most widely accepted.

Transfer RNA (tRNA) is an essential component of the protein synthesis reaction. There are at least twenty different kinds of tRNA in the cell<sup>1</sup> and each one serves as the carrier of a specific amino acid to the site of translation.

tRNA's are L-shaped molecules. The amino acid is attached to one end and the other end consists of three anticodon nucleotides. The anticodon pairs with a codon in messenger RNA (mRNA) ensuring that the correct amino acid is incorporated into the growing polypeptide chain.

The L-shaped tRNA is formed from a small single-stranded RNA molecule that folds into the proper conformation. Four different regions of double-stranded RNA are formed during the folding process.

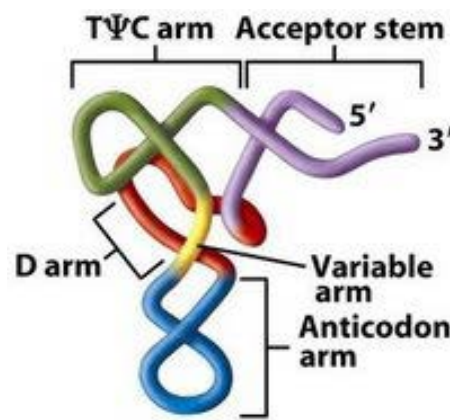

The two ends of the molecule form the *acceptor stem* region where the amino acid is attached. The anticodon is an exposed single-stranded region in a loop at the end of the *anticodon arm*.

The two other stem/loop structures are named after the modified nucleotides that are found in those parts of the molecule. The *D arm* contains dihydrouridylate residues while the *TΨC arm* contains a ribothymidylate residue (T), a pseudouridylate residue (Ψ) and a cytidylate (C) residue in that order. All tRNA's have a similar *TΨC* sequence. The *variable arm* is variable, just as you would expect. In some tRNA's it is barely noticeable while in others it is the largest arm.

tRNA's are usually drawn in the "cloverleaf" form (below) to emphasize the base-pairs in the secondary structure.

### Clover leaf model of tRNA

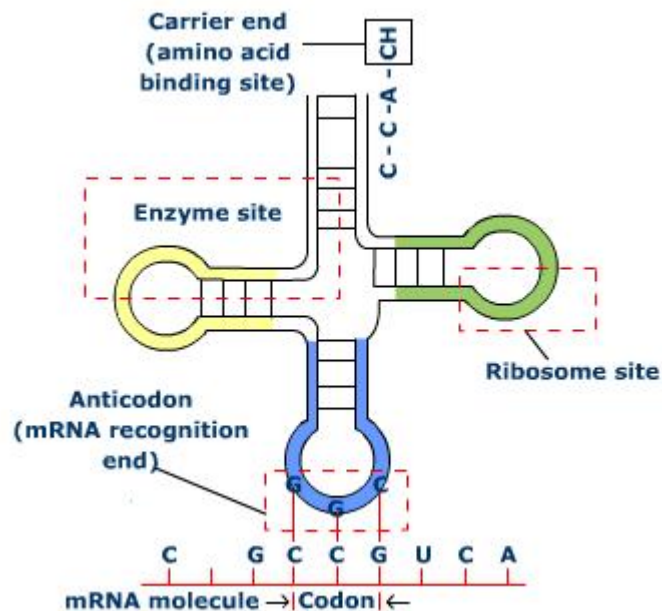

### Unusual Bases in tRNA

In addition to the usual bases A, U, G and C, tRNA contain a number of unusual bases, and in this respect differs from mRNA and rRNA. The unusual bases of tRNA account for 15-20% of the total RNA of the cell. Most of the unusual bases are formed by methylation (addition of -CH<sub>3</sub> or methyl group to the usual bases), e.g. cytosine and guanine on methylation yield methylcytosine and methyl/guanine, respectively.

Precursor tRNA molecules transcribed on the DNA template contains the usual bases. These are then modified to unusual bases. The unusual bases are important because they protect the tRNA molecule against degradation by RNase. This protection is necessary because RNA is found floating freely in the cell.

Some of the unusual bases of tRNA are methyl guanine (GMe), dimethylguanine(GMe<sub>2</sub>), methylcytosine (Me), ribothymine (T), pseudouridine ( $\psi$ ), dihydrouridine (DHU, H<sub>2</sub>U, UH<sub>2</sub>), inosine (I) and methylinosine (IMe, MeI). In general, organisms high in the evolutionary scale contain more modified bases than lower organisms.

**Classification of tRNA** - A Study of different tRNAs shows that the structure of the acceptor stem, the anticodon arm and the T $\psi$ C arm are constant. The differences in

the tRNAs lie in the D arm and the variable arm. Based on the differences in these two variable regions, three classes of tRNA have been recognized.

**Class I (D4-V4-5)**, with 4 base pairs in the D stem and 4-5 bases in the variable loop.

**Class II (DS-V4-5)**, with 3 base pairs in the D stem and 4-5 bases pairs in the variable loop.

**Class III (D3-VN)**, with 3 base pairs in the D stem and a large variable arm.

A simpler classification based only on the variable arm recognizes two types of tRNA.

Class I with 4-5 bases in the variable loop

Class II with a large variable arm of 13-21 bases.

**Tertiary Structure of Transfer - tRNA** - Electron density maps have revealed that tRNA has a tertiary structure. This structure is due to hydrogen bonds

- (i) between bases,
- (ii) between bases and ribose phosphate backbone and
- (iii) between the backbone residues. (The hydrogen bonding in the double helical stem regions of the tRNA molecular are considered to be in the secondary structure).

### **Initiator Transfer RNA - tRNA**

The starting amino acid in eukaryote protein synthesis is methionine, while in prokaryotes it is N-formyl methionine. The tRNA molecule<sup>3</sup> specific for these two amino acids are methionyl tRNA (tRNA<sup>met</sup>) and N-formyl- methionyl tRNA (tRNA<sup>fmet</sup>) respectively.

These tRNAs are called initiator tRNAs, because they initiate protein synthesis. Initiator tRNAs have certain features which distinguish them from other tRNAs, and the initiator tRNAs of prokaryotes' and eukaryotes also differ.

In most prokaryotes the 5' terminal nucleoside is C. It has opposite it (i.e. in the fifth position from the 3' end) an A nucleotide. There is no Watson-Crick base pairing between the two. In the blue green 'alga' *Anacystis nidulans*, however, the fifth nucleotide from the 3' end is C. In eukaryotes there is an A.U base pair at the acceptor stem.

As noted previously, prokaryotes use tRNA<sup>f-met</sup> for initiation of protein synthesis, while eukaryotes use tRNA<sup>met</sup>. The prokaryote *Halo bacterium cutirubrum* is, however, reported to initiate protein synthesis with tRNA<sup>met</sup> and has an A.U base pair at the end of the acceptor stem. In these respects it resembles eukaryotes

The D loop of prokaryote initiator tRNAs contains an A11, U24 base pair. All other tRNAs have a Y11, R24 base pair. Eukaryotic cytoplasmic initiator tRNAs have AU or AU\* instead of T $\psi$  in the T $\psi$ C loop. Also, in eukaryotes instead of a pyrimidine nucleotide (Y) there is A at the 3' end of the T $\psi$ C loop.

In some eukaryotic cytoplasmic initiator tRNAs the anticodon sequence CAU is preceded by C instead of U as in all other tRNAs. In prokaryotes the purine nucleotide following C in the T $\psi$ C loop is A, while in eukaryotes it is G. In tRNA<sup>f-met</sup> the nucleotide adjacent to the 3' side of the anticodon triplet is adenosine while in tRNA<sup>met</sup> it is alkylated adenosine

### **Specificity of Transfer RNA - tRNA**

Two important steps in translation during protein synthesis are the activation of amino acids and the transfer of amino acids to tRNAs. Each amino acid has a specific activating enzyme tRNA aminoacyl synthetase. Thus there are 20 different tRNA aminoacyl synthetases for the 20 common amino acids found in proteins.

Some tRNA synthetases can activate more than one amino acid, i.e. they show only a limited substrate specificity. Thus isoleucine tRNA synthetase can also activate L valine, and valine tRNA synthetase can also react with threonine. The enzymes, however, recognize only a specific set of tRNAs as substrates. Isoleucine tRNA synthetase recognizes only tRNA<sup>ileu</sup> and valine tRNA synthetase recognizes only tRNA<sup>val</sup>. Thus specificity is involved at two stages, activation of the amino acid and transfer of the amino acid to tRNA. Another group of enzymes, the tRNA aminoacyl transferases catalyse the transfer of an amino acid from the amino acid - tRNA complex to specific acceptor molecules.

## TRANSCRIPTION – TRANSLATION - GENETIC CODE AND OUTLINE OF PROTEIN SYNTHESIS

### Central Dogma of Protein Synthesis

Proteins constitute the major part by dry weight of an actively growing cell. They are widely distributed in living matter. All enzymes are proteins. Proteins are built up from about 20 amino acids which constitute the basic building blocks. In proteins the amino acids are linked up by peptide bonds to form long chains called polypeptides.

The sequence of amino acids has a bearing on the properties of a protein, and is characteristic for a particular protein. The basic mechanism of protein synthesis is that DNA makes RNA, which in turn makes protein. The central dogma of protein synthesis is expressed as follows:

DNA ----->	DNA ----->	RNA ----->	PROTEIN
Replication	Transcription	Translation	

### Noble Prize Winners in Protein Synthesis

Nobel prize winners. In the last 15 years several Nobel prizes in physiology and medicine have been awarded for work done on nucleic acids and protein synthesis. In 1975 Alexander Todd of Great Britain was awarded the prize for his studies on nucleotides and nucleotidic coenzymes.

The 1958 prize went to Beadle and Tatum for their work showing that one gene is responsible for one enzyme. Lederberg also shared the prize for his work on genetic recombination. The 1959 Nobel prize was shared by Ochoa and Kornberg for successful synthesis of RNA and DNA, respectively.

Watson of U. S. A and Crick and Wilkins of Great Britain received the 1962 prize for elucidating the structure of DNA. In 1965 the prize was awarded to Jacob, Monod and Lwoff of France for their discovery of regulator genes.

The 1968 prize went to the Americans Nirenberg and Khorana for their work on the genetic code, and to Holley (also of U. S. A.) for his finding out the nucleotide sequence of tRNA. In 1969 Delbruck, Hershey and Luria received the prize for their

work on the reproductive pattern of viruses, In 1975 Temin was awarded the Nobel prize for his work on RNA directed DNA synthesis.

### PROTEIN SYNTHESIS

Proteins are widely used in cells to serve diverse functions. Some proteins provide the structural support for cells while others act as enzymes to catalyze certain reactions. We have already seen the roles that different enzymes play in building the cell's structure and in catalyzing metabolic reactions, but where do proteins come from?

Since the beginning of evolution, cells have developed the ability to synthesize proteins. They can produce new proteins either for reproduction or to simply replace a degraded one. To manufacture proteins, cells follow a very systematic procedure that first transcribes DNA into mRNA and then translates the mRNA into chains of amino acids. The amino acid chain then folds into specific proteins.

Protein synthesis requires two steps: **transcription** and **translation**.

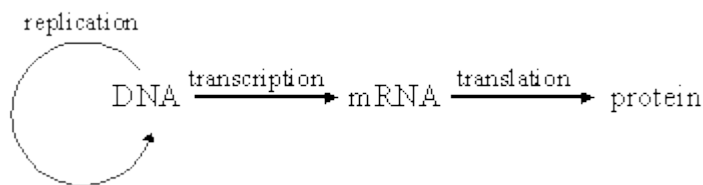

Ribonucleic acid (RNA) was discovered after DNA. DNA, with exceptions in chloroplasts and mitochondria, is restricted to the nucleus (in eukaryotes, the nucleoid region in prokaryotes). RNA occurs in the nucleus as well as in the cytoplasm (also remember that it occurs as part of the ribosomes that line the rough endoplasmic reticulum).

Crick's central dogma. Information flow (with the exception of reverse transcription) is from DNA to RNA via the process of transcription, and thence to protein via translation. Transcription is the making of an RNA molecule off a DNA template. Translation is the construction of an amino acid sequence (polypeptide) from an RNA molecule. Although originally called dogma, this idea has been tested repeatedly with almost no exceptions to the rule being found.



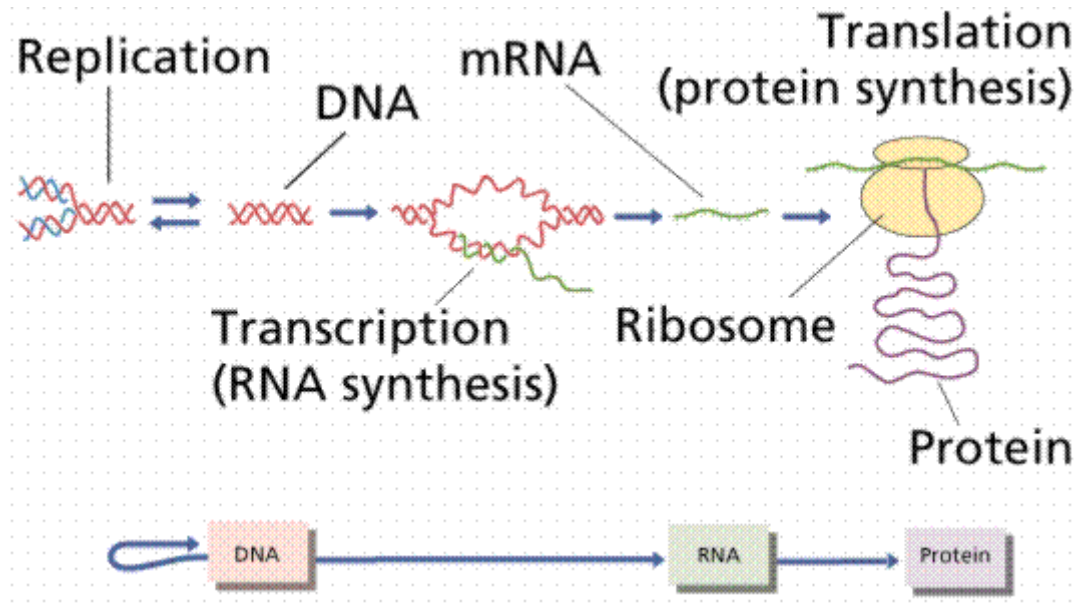

**Step 1: DNA Transcription**

Protein synthesis begins in the cell's nucleus when the gene encoding a protein is copied into RNA. Genes, in the form of DNA, are embedded in in the cell's chromosomes. The process of transferring the gene's DNA into RNA is called transcription. Transcription helps to magnify the amount of DNA by creating many copies of RNA that can act as the template for protein synthesis. The RNA copy of the gene is called the mRNA.

DNA and RNA are both constructed by a chain of nucleotides. However, RNA differs from DNA by the substitution of uracil (U) for thymine (T). Also, because only one strand of mRNA is needed when synthesizing proteins, mRNA naturally exist in single-stranded forms.

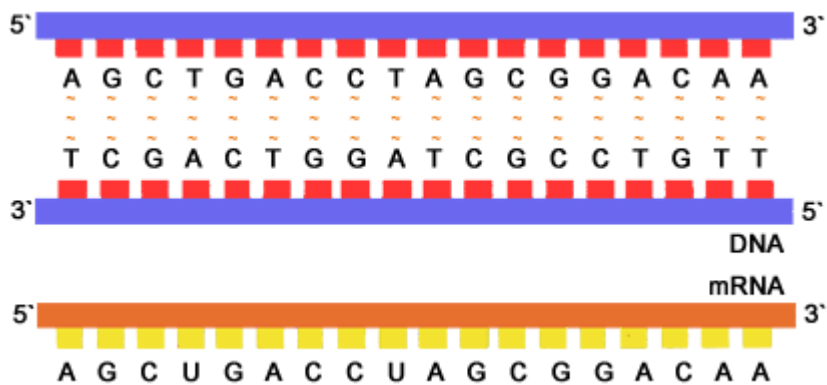

After transcription, the mRNA is transported out of the cell's nucleus through nuclear pores to go to the site of translation, the rough endoplasmic reticulum.

Transcription is a process of making an RNA strand from a DNA template, and the RNA molecule that is made is called transcript. In the synthesis of proteins, there are actually three types of RNA that participate and play different roles:

**a. Messenger RNA(mRNA)** which carries the genetic information from DNA and is used as a template for protein synthesis.

**b. Ribosomal RNA(rRNA)** which is a major constituent of the cellular particles called ribosomes on which protein synthesis actually takes place.

**c. A set of transfer RNA(tRNA)** molecules, each of which incorporates a particular amino acid subunit into the growing protein when it recognizes a specific group of three adjacent bases in the mRNA.

DNA maintains genetic information in the nucleus. RNA takes that information into the cytoplasm, where the cell uses it to construct specific proteins, RNA synthesis is transcription; protein synthesis is translation.

RNA differs from DNA in that it is single stranded, contains Uracil instead of Thymine and ribose instead of deoxyribose, and has different functions. The central dogma depicts RNA as a messenger between gene and protein, but does not adequately describe RNA's other function.

Transcription is highly controlled and complex. In Prokaryotes, genes are expressed as required, and in multicellular organisms, specialized cell types express subsets of gene. Transcription factors recognize sequences near a gene and bind sequentially, creating a binding transcription. Transcription proceeds as RNAP inserts complementary RNA bases opposite the coding strand of DNA. Antisense RNA blocks gene expression.

Messenger RNA transmits information in a gene to cellular structures that build proteins. Each three mRNA bases in a row forms a codon that specifies a particular amino acid. Ribosomal RNA and proteins form ribosomes, which physically support the other participants in protein synthesis and help catalyze formation of bonds between amino acids.

In eukaryotes, RNA is often altered before it is active. Messenger RNA gains a cap of modified nucleotides and a poly A tail. Introns are transcribed and cut out,

and exons are reattached by ribozymes. RNA editing introduced bases changes that alter the protein product in different cell types.

The genetic code is triplet, non-overlapping, continuous, universal, and degenerate. As translation begins, mRNA, tRNA with bound amino acids, ribosomes, energy molecules and protein factors assemble. The mRNA leader sequence binds to rRNA in the small subunit of a ribosome, and the first codon attracts a tRNA bearing methionine. Next, as the chain elongates, the large ribosomal subunit attaches and the appropriate anticodon parts of tRNA molecules form peptide bonds, a polypeptide grows. At a stop codon, protein synthesis ceases. Protein folding begins as translation proceeds, with enzymes and chaperone proteins assisting the amino acid chain in assuming its final functional form. Translation is efficient and economical, as RNA, ribosomes, enzymes, and key proteins are recycled.

### **RNA transcription requires the following components**

The enzyme RNA polymerase

- A DNA template
- All four types of ribonucleoside triphosphates (ATP, GTP and UTP)
- Divalent metal ions  $Mg^{++}$  or  $Mn^{++}$  as a co-factor
- No primer is needed for RNA synthesis
- RNA transcription is a process that involves the following steps.

### **Binding of RNA Polymerase to DNA Double Helix**

The histone coat protecting the DNA double helix of the gene to be transcribed is removed, on a signal from the cytoplasm, exposing the polynucleotide sequences in this region of DNA. The RNA polymerase enzyme binds to a specific site, called promoter, in the DNA double helix. This site is located on the 5' side of the gene to be transcribed. It signals the beginning of RNA synthesis. The promoter also determines the DNA strand that is to be transcribed.

### **Exposure of RNA Bases**

The histone coat protecting the DNA double helix of the gene to be transcribed is removed, on a signal from the cytoplasm, exposing the polynucleotide sequences in this region of DNA. The RNA polymerase enzyme binds to a specific site, called promoter, in the DNA double helix. This site is located on the 5' side of the gene to be transcribed. It signals the beginning of RNA synthesis.

The promoter also determines the DNA strand that transcription is not known.

**Base pairing**

The ribonucleoside triphosphates, namely, adenosine triphosphate (ATP), guanosine triphosphate (GTP), cytidine triphosphate (CTP) and uridine triphosphate (UTP), floating free in the nucleus, serve as the raw material for RNA synthesis. They are formed by activation (phosphorylation) of ribonucleoside monophosphates, viz., adenosine monophosphate (AMP), guanosine monophosphate (GMP), cytidine monophosphate (CMP) and uridine monophosphate (UMP) as a result of their combining with ATP. The enzyme phosphorylase catalyses this activation process. The ribonucleotide triphosphates are joined to the bases of the DNA template chain one by one by hydrogen bonding according to the base pairing rule i.e., A U, U A, C G, G C. This base pairing is brought about by the RNA polymerase.

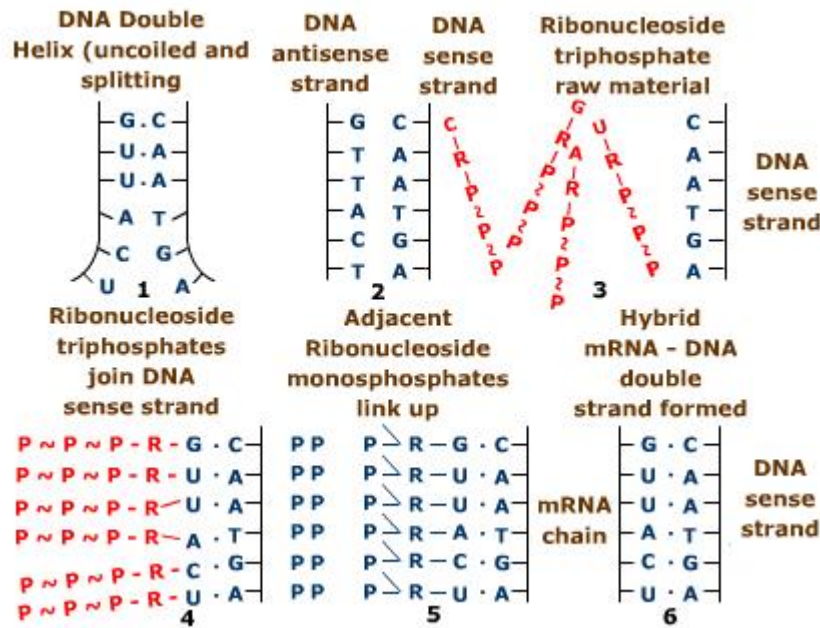

Synthesis of mRNA from DNA

The nucleotides are added one by one. A=Adenine, T=Thymine, C=Cytosine, G=Guanine, U=Uracil, R=Ribose sugar, P=Phosphate

**Conversion to Ribonucleoside Monophosphates**

The various ribonucleoside triphosphates on linking to the DNA template chain break off their high-energy bonds. This changes them to ribonucleoside monophosphates which represent the normal components of RNA, and sets free pyrophosphate groups (P~P). Pyrophosphate contains a high-energy bond (~). It undergoes hydrolysis by the enzyme pyrophosphatase, releases energy and sets free inorganic phosphate Pi. The first ribonucleotide phosphate retains all the three phosphates and is, thus, chemically distinct from the other nucleotides added after it



### Formation of RNA Chain

Each ribonucleoside monophosphate attached to the DNA template chain then combines with the ribonucleotide arrived earlier, making the RNA chain become longer. The process is catalysed by the enzyme RNA polymerase and requires a divalent ion Mg<sup>++</sup> or Mn<sup>++</sup>. The RNA chain, thus formed, contains nitrogenous bases that are complementary to those of the template **DNA** chain.

### Separation of RNA Chain

As transcription proceeds, the hybrid DNA-RNA molecule dissociates, partly releasing the RNA molecule under synthesis. When polymerase reaches a terminator signal on the DNA, it leaves the DNA. The fully formed RNA chain is now totally released by this process, one gene forms several molecules of RNA, which get released from the DNA template one after the other.

In some cases, such as in *E. coli*, a specific chain terminating protein, called rho factor (P), stops the synthesis of RNA chain. In most cases, the enzyme RNA polymerase on its own can stop transcription.

### Return of DNA Segment to Original Form

As the RNA chain grows, the transcribed region of the DNA molecule gets hydrogen bonded to the opposite strand and the two become spirally coiled to assume the original double helical form. When the last ribonucleotide is added, the RNA polymerase and RNA chain are completely released from the DNA, and now the DNA completes its winding into a double helix. The protective protein coat is added again to the DNA duplex.

The sequence of nitrogen bases from the promoter to the terminator sites form a transcription unit. It may include one or more genes. An entire transcription unit gets transcribed into a single RNA chain.

### Processing of RNAs

The forms of RNAs originally transcribed from DNA are called primary transcripts. These undergo extensive changes, termed processing or post-transcriptional modification of RNAs, before they can become functional in both prokaryotes and eukaryotes.

#### In RNA processing,

- Larger RNA precursors are cut into smaller RNAs by a ribonuclease-P cleaving enzyme
- Unwanted nucleotides are removed by enzymes called nucleases (splicing)
- Useful regions are rejoined by ligase enzyme
- Certain nucleotides are added at the terminal ends enzymatically (terminal addition)
- The RNA molecule may fold on itself to assume proper shape (folding) and
- Some nucleotides may be modified (nucleotide modification)

The entire process of RNA transcription may be summed up in the equation  
(ATP + GTP +CTP +UTP) n

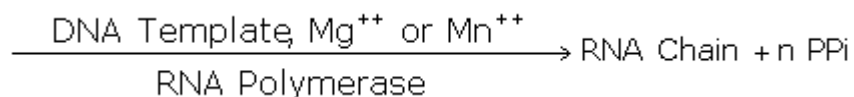

### RNA TYPES

The three different types of RNA, namely, messenger RNA (mRNA), ribosomal RNA (rRNA) and transfer RNA (tRNA) are transcribed from different regions of the DNA molecule. Three different RNA polymerases: I, II and III catalyses the transcription of rRNA, mRNA and tRNA respectively in eukaryotes. In prokaryotes, a single RNA polymerase composed of different subunits does this work. Transcription of RNA also occurs in the 5-3 direction like the replication of DNA.

### Step 2: RNA Translation

After the mRNA has been transported to the rough endoplasmic reticulum, it is fed into the ribosomal translation machineries. Ribosomes begins to read the mRNA sequence from the 5` end to the 3` end. To convert the mRNA into protein, tRNA is used to read the mRNA sequence, 3 nucleotides at a time.

Amino acids are represented by codons, which are 3-nucleotide RNA sequences. The mRNA sequence is matched three nucleotides at a time to a complementary set of three nucleotides in the anticodon region of the corresponding tRNA molecule. Opposite the anticodon region of each tRNA, an amino acid is attached and as the mRNA is read off, the amino acids on each tRNA are joined together through peptide bonds.

Translation is the mechanism by which the triplet base sequence of an mRNA guides the linking of a specific sequence of amino acids to form a polypeptide (protein) on ribosomes. All the proteins a cell needs are synthesized by the cell within itself.

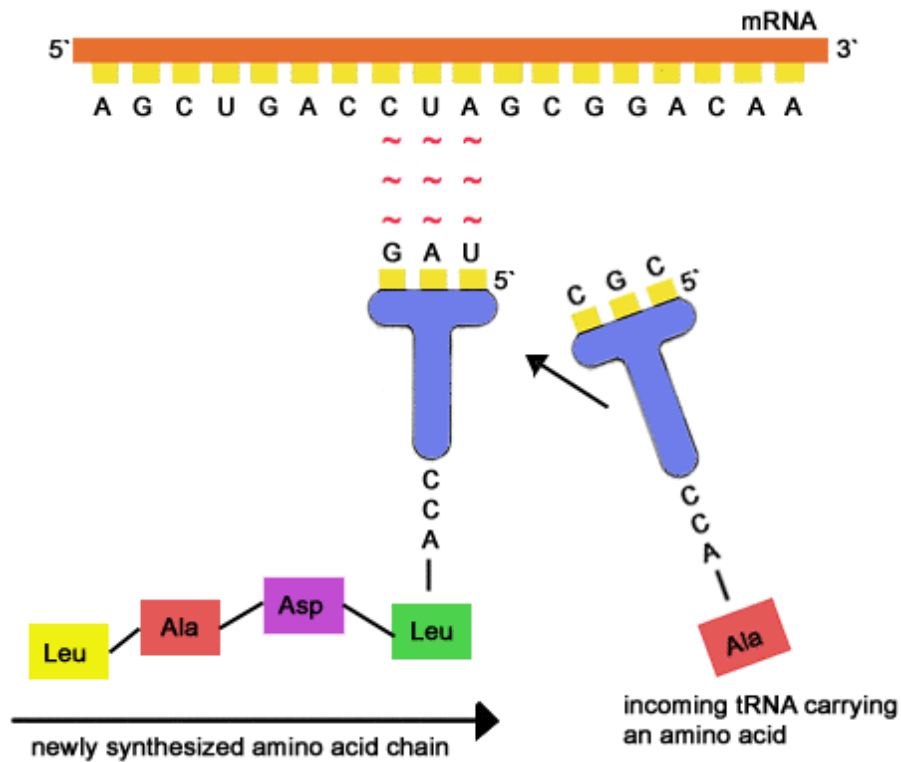

### **Machinery for Protein Synthesis**

Protein synthesis requires amino acids, DNA, RNAs, ribosomes and enzymes, enzyme activators and ATP molecules

#### **Amino Acids**

Proteins are the polymers of amino acids. Therefore, amino acids form the raw material for protein synthesis. The proteins found in living organisms need about 20 amino acids as building blocks or monomers. These are available in the cytoplasmic matrix as an amino acid pool.

#### **DNA as Specificity Control**

In order to maintain its own special characteristics a cell must manufacture proteins exactly similar to those already present in it. Thus, protein synthesis requires specificity control to provide instructions about the exact sequence in which the given numbers and kinds of amino acids should be linked to form the desired polypeptides. The specificity control is exercised by DNA through mRNA. Sequences of 3 consecutive nitrogenous bases in the DNA double helix form the biochemical or genetic code. Each base triplet codes for a specific amino acid. Since the DNA is more or less stable, the proteins formed in a cell are exactly like the preexisting proteins

#### **RNAs**

RNA molecule is a long, unbranched, single-stranded polymer of ribonucleotides. Each nucleotide unit is composed of three smaller molecules, a phosphate group, a 5-carbon ribose sugar, and a nitrogen-containing base. The bases in RNA are adenine, guanine, uracil and cytosine. The various components are linked up as in DNA. There are three types of RNA in every cell: messenger RNA or mRNA, ribosomal RNA or rRNA and transfer RNA or tRNA. The three types of RNAs are transcribed from different regions of DNA template. RNA chain is complementary to the DNA strand, which produces it. All the three kinds of RNAs play a role in protein synthesis.

#### **Differences Between RNA Types**

<b>Features</b>	<b>Ribosomal RNA (rRNA)</b>	<b>Messenger RNA (mRNA)</b>	<b>Transfer RNA (tRNA)</b>
-----------------	-----------------------------	-----------------------------	----------------------------



1. Percentage of cell's total RNA	About 80	About 5	About 15
2. Length of molecule	Variable	Longest	Shortest
3. Shape of molecule	Greatly coiled	Linear	Clover leaf- like, folded into L- shape
4. Types	Six	Numerous	About 60
5. Role	Form greater part of ribosome's	Carry information from DNA	Carry amino acids to mRNA codons
6. Life	Long, used again and again in translation	Very short, 2 minutes to 4 hours, degraded after translation	Long, used again and again in translation

### **mRNA**

The DNA, that controls protein synthesis, is located in the chromosomes within the nucleus, whereas the ribosomes, on which the protein synthesis actually occurs, are placed in the cytoplasm. Therefore, some sort of agency must exist to carry instructions from the DNA to the ribosomes. This agency does exist in the form of mRNA. The mRNA molecule carries the message (information) from DNA about the sequence of particular amino acids to be form a polypeptide, hence its name. It is also called informational RNA or template RNA. The mRNA forms about 5% of the total RNA of a cell. Its molecule is linear and the longest of all the three RNA types. Its length is related to the size of the polypeptide to be synthesized with its information. There is a specific mRNA for each polypeptide. Because of the variation in size in mRNA population in a cell; the mRNA is often called heterogeneous nuclear RNA, or hnRNA

It has at its 5 end a cap of methylated guanine followed successively by an initiation codon (AUG or GUG), a long coding region, a termination codon (UAA or UAG or UGA) and a poly-A tail of many adenine-containing nucleotides at 3 end. A small non-coding region may be present after the head and before tail

In eukaryotes, mRNA carries information for one polypeptide only. It is monocistronic (monogenic) because it is transcribed from a single cistron (gene) and has a single terminator codon

Bacterial mRNA often carries information for more than one polypeptide chain. Such an mRNA is said to be polycistronic (polygenic) because it is transcribed from many continuous (adjacent) genes. A polycistronic mRNA has an initiator codon and a terminator codon for each polypeptide to be formed by it.

### **tRNA**

The tRNA carries a specific amino acid from the amino acid pool to the mRNA on the ribosomes to form a polypeptide, hence its name. The tRNAs form about 15% of the total RNA of a cell. Its molecule is the smallest and has the form of a cloverleaf. It has four regions.

**Carrier End:** This is the 3' end of the molecule. Here a specific amino acid becomes attached. The tRNA molecule has a base triplet CCA with OH group at the tip. The COOH of amino acid joins the OH group.

**Recognition End:** It is the opposite end of the molecule. It has 3 unpaired ribonucleotides. The bases of these ribonucleotides are complementary bases of the triplet found on mRNA chain called a codon. This triplet base sequence in tRNA is called as an anticodon. The anticodon binds with the codon at the time of translation.

**Enzyme Site:** It is on one lateral side of the molecule. It is meant for a specific charging enzyme which catalyses the binding of a specific amino acid to tRNA molecule.

**Ribosome Site:** It is on the other lateral side of the molecule. It is meant for attachment to a ribosome.

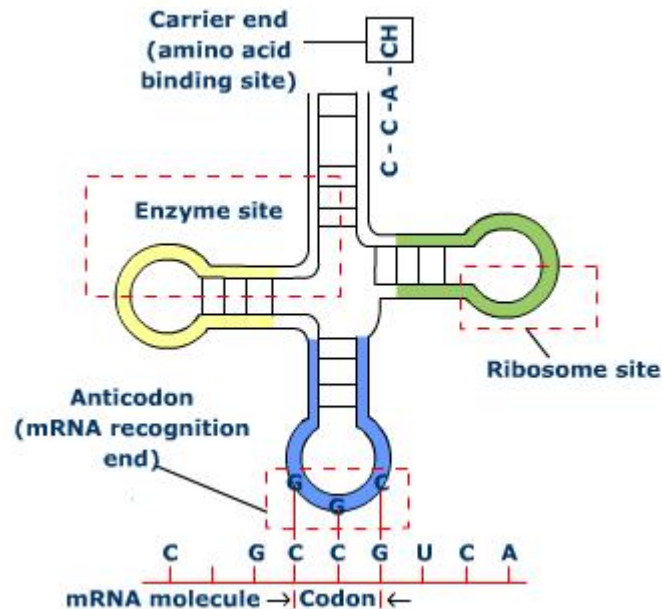

## rRNA

The rRNA molecule is greatly coiled. In combination with proteins, it forms the small and large subunits of the ribosomes, hence its name. It forms about 80% of the total RNA of a cell. A eukaryotic ribosome is 80S; with a large 60S subunit consists of 28S, 5.8S and 5S rRNAs and over 45 different basic proteins, the smaller 40S subunit comprises 18S RNA and about 33 different basic proteins. A prokaryotic ribosome is 70S; its large 50S subunit consists of 23S and 5S rRNAs and about 34 different basic proteins; its small 30S subunit comprises 16S rRNA and about 21 different basic proteins. The 3' end of 18S rRNA (16S rRNA in prokaryotes) has a binding site for the mRNA cap. The 5S rRNA has a binding site for tRNA. The rRNA also seems to play some general role in protein synthesis. It is involved in assembling the amino acid molecules brought by tRNA, into a polypeptide chain

There are two more types of RNA, recognised in the cell namely

Small nuclear RNA (snRNA) that helps in processing of rRNA and mRNA and

Small cytoplasmic RNA (scRNA) which helps in binding the ribosome to ER

## Ribosomes

Ribosomes are tiny ribonucleoprotein particles without a covering membrane. They serve as the site for protein synthesis. Hence, they are called protein factories of the cell. Each ribosome consists of larger and smaller subunits. The subunits of ribosome occur separately when ribosomes are not involved in protein synthesis. The two subunits join when protein synthesis starts, and undergo dissociation (separate) when protein synthesis stops. Many ribosomes line up on the mRNA chain during protein synthesis. Such a group of active ribosomes is called a polyribosome, or a polysome. In a polysome, the adjacent ribosomes are about 340 Å apart. The number of ribosomes in a polysome is related to the length of the mRNA molecule, which reflects the length of the polypeptides to be synthesized. It is now known that polypeptide synthesis occurs at the polysomes and not at the single free ribosomes, in both prokaryotes and eukaryotes.

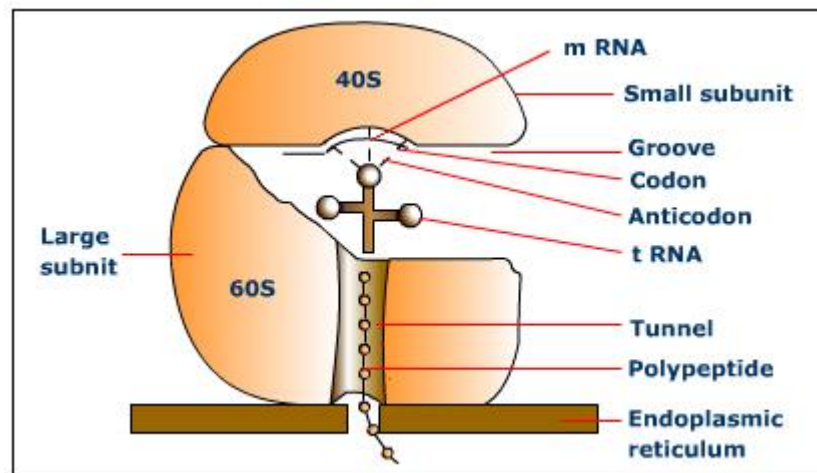

A ribosome has two binding sites for tRNA molecules. One is called A site (acceptor or aminoacyl) and the other is termed P site (peptidyl). These sites span across the larger and smaller subunits of the ribosome. The A site receives the tRNA amino acid complex. The tRNA leaves from P site, after releasing its amino acid. However, the first tRNA amino acid complex directly enters the P site of the ribosome.

A eukaryotic ribosome has a groove at the junction of the two subunits. From this groove, a tunnel extends through the large subunit and opens into a canal of

the endoplasmic reticulum. The polypeptides are synthesized in the groove between the two ribosomal subunits and pass through the tunnel of the large subunit into the endoplasmic reticulum. While in the groove, the developing polypeptide is protected from the cellular enzymes.

The smaller subunit forms a cap over the larger subunit. The larger subunit attaches to the endoplasmic reticulum by two glycoproteins named ribophorin I and II.

The function of the ribosome is to hold the mRNA, tRNA and the associated enzymes controlling the process in position, until a peptide bond is formed between the adjacent amino acids

### **Mechanism of Protein Synthesis**

The events in protein synthesis are better known in bacteria than in eukaryotes. Although these are thought to be similar in the two groups there are some differences. The following description refers mainly to protein synthesis in bacteria on the 70S ribosome.

Protein synthesis is a highly complex and an elaborate process and involves the following steps:

#### **Activation of Amino Acids**

It is the step in which each of the participating amino acid reacts with ATP to form amino acid AMP complex and pyrophosphate. The reaction is catalyzed by a specific amino acid activating enzyme called aminoacyl-tRNA synthetase in the presence of  $Mg^{2+}$ . There is a separate aminoacyl tRNA synthetase enzyme for each kind of amino acid. Much of the energy released by the separation of phosphate groups from ATP is trapped in the amino acid AMP complex. The complex remains temporarily associated with the enzyme. The amino acid AMP enzyme complex is called an activated amino acid. The pyrophosphate is hydrolyzed to two inorganic phosphates (2pi)

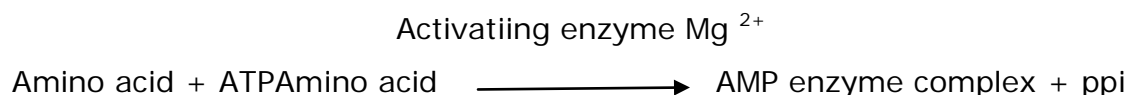

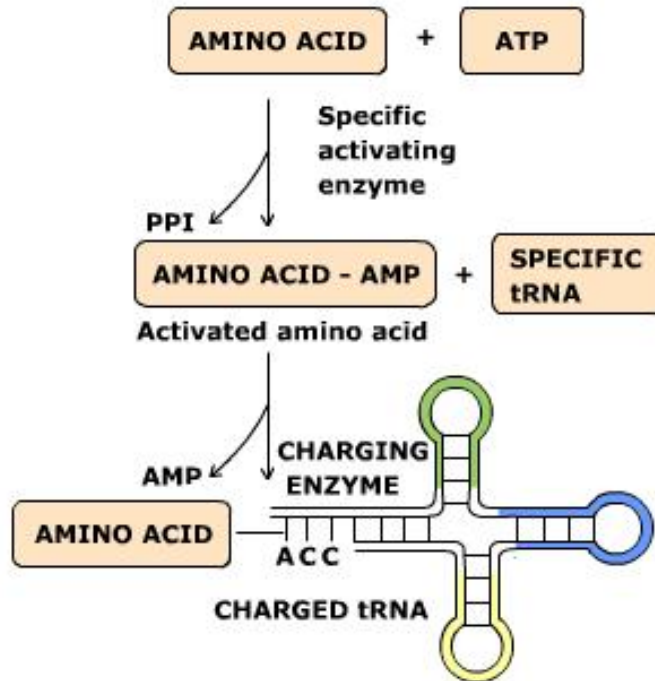

### Activation of Amino Acids

#### Charging of tRNA

It is the step in which the amino acid AMP-enzyme complex joins with the amino acid binding site of its specific tRNA, where its COOH group bonds with the OH group of the terminal base triplet CCA. The reaction is catalyzed by the same enzyme, aminoacyl tRNA synthetase. The resulting tRNA-amino acid complex is called a charged tRNA. AMP and enzyme are released. The released enzyme can activate and attach another amino acid molecule to another tRNA molecule. The energy released by change of ATP to AMP is retained in the amino acid-tRNA complex. This energy is later used to drive the formation of peptide bond when amino acids link together and form a polypeptide

Amino acid AMP Enzyme complex + t RNA

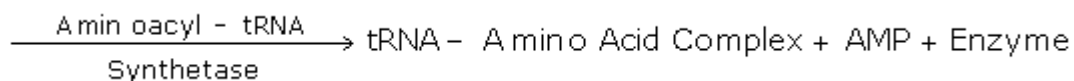

The tRNA amino acid complex moves to the ribosomes, the site of protein synthesis.

### **Activation of Ribosome**

It is the step in which the smaller and the larger subunits of ribosome are joined together. This is brought about by mRNA chain. The latter joins the smaller ribosomal subunit with the help of the first codon by a base pairing with an appropriate sequence on rRNA. The combination of the two is called initiation complex. The larger subunit later joins the small subunit, forming active ribosome. Activation of ribosome by mRNA requires proper concentration of  $Mg^{++}$

### **Assembly of Amino Acids (Polypeptide Formation)**

It is the step in which the amino acids are assembled into a polypeptide chain. It involves 3 events: initiation, elongation and termination of polypeptide chain

#### **Initiation of Polypeptide Chain**

The mRNA chain has at its 5 end an "initiator" or "start" codon (AUG or GUG) that signals the beginning of polypeptide formation. This codon lies close to the P site of the ribosome. The amino acid formylmethionine (methionine in eukaryotes) initiates the process. It is carried by tRNA having an anticodon UAC which bonds with the initiator codon AUG of mRNA. Initiation factors (IF1, IF2 and IF3) and GTP promote the initiation process.

The large ribosomal subunit now joins the small subunit to complete the ribosome. At this stage, GTP is hydrolysed to GDP. The ribosome has formylmethionine bearing tRNA at the P site. Later, the formylmethionine is changed to normal methionine by the enzyme deformylase in prokaryotes. If not required, methionine is later separated from the polypeptide chain by a proteolytic enzyme aminopeptidase.

#### **Elongation of Polypeptide Chain**

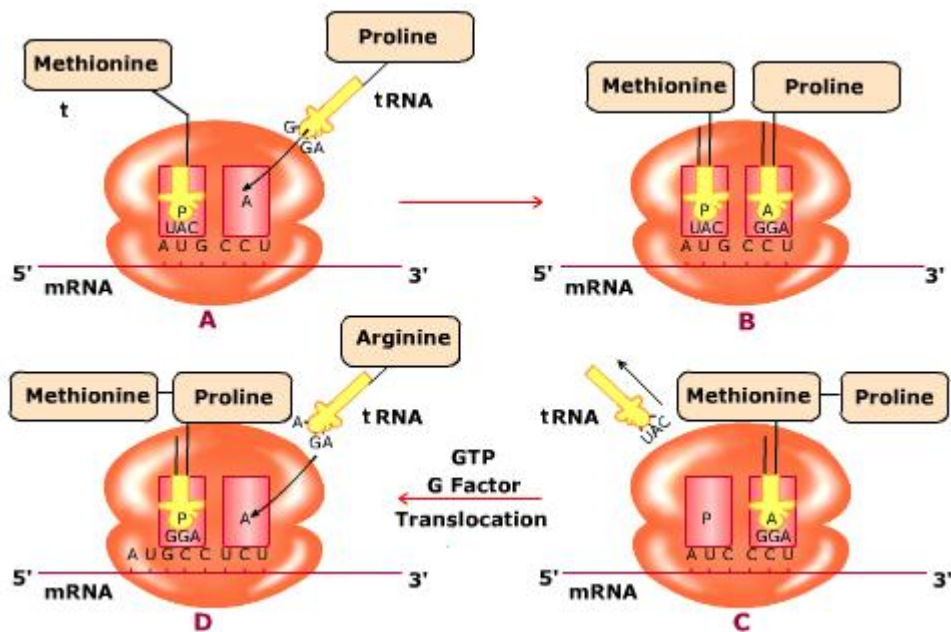

The above figure shows,

- A. A charged tRNA arriving at the A site, reading its codon on the mRNA
- B. Amino acid of tRNA at P site is ready to be transferred to the amino acid of tRNA at A site
- C. Amino acids are joined by peptide bond and tRNA is discharged from P site
- D. Peptide chain-carrying tRNA is translocated to P site, making A site free to receive another charged tRNA

Three elongation factors (EF Tu, EF Ts and EF G) assist in the elongation of the polypeptide chain. A charged tRNA molecule along with its amino acid, proline, for example, enters the ribosome at the A site. Its anticodon GGA locates and binds with the complementary codon CCU of mRNA chain by hydrogen bonds. The amino acid methionine is transferred from its tRNA onto the newly arrived proline tRNA complex where the two amino acids join by a peptide bond. The process is catalyzed by the enzyme peptidyl transferase located on the ribosome. In this process, the linkage between the first amino acid and its tRNA is broken, and the -COOH group now forms a peptide bond with the free -NH<sub>2</sub> group of the second amino acid. Thus, the second tRNA carries a dipeptide, formylmethionineproline.



The energy required for the formation of a peptide bond comes from the free energy released by separation of amino acid (formylmethionine or methionine) from its tRNA.

The first tRNA, now uncharged, separates from mRNA chain at the P site of the ribosome and returns to the mixed pool of tRNAs in the cytoplasm. Here, it is now available to transport another molecule of its specific amino acid.

Now the ribosome moves one codon along the mRNA in the 3' direction. With this, tRNA<sup>dipeptide</sup> complex at the A site is pulled to the P site. This process is called translocation. It requires GTP and a translocase protein called EF-G factor. The GTP is hydrolysed to GDP and inorganic phosphate to release energy for the process

At this stage, a third tRNA molecule with its own specific amino acid, arginine, for example arrives at the A site of the ribosome and binds with the help of anticodon AGA to the complementary codon UCU of the mRNA chain. The dipeptide formylmethionine-proline is shifted from the preceding tRNA on the third tRNA where it joins the amino acid arginine again with the help of peptidyl transferase enzyme. The dipeptide, thus, becomes a tripeptide, formyl-methionine-proline-arginine. The second tRNA being now uncharged, leaves the mRNA chain, vacating the P site. The tRNA<sup>tripeptide</sup> complex is translocated from A site to P site. The entire process involving arrival of tRNA-amino acid complex, peptide bond formation and translocation is repeated. As the ribosome moves over the mRNA, all the codons of mRNA arrive at the A site one after another, and the peptide chain grows. Thus, the amino acids are linked up into a polypeptide in a sequence communicated by the DNA through the mRNA. A polypeptide chain which is in the process of synthesis is often called a nascent polypeptide

The growing polypeptide chain always remains attached to its original ribosome, and is not transferred from one ribosome to another. Only one polypeptide chain can be synthesized at a time on a given ribosome.

### **Termination and Release of Polypeptide Chain:**

At the terminal end of mRNA chain there is a stop, or terminator codon (UAA, UAG or UGA). It is not joined by the anticodon of any tRNA amino acid complex. Hence, there can be no further addition of amino acids to the polypeptide chain.

The linkage between the last tRNA and the polypeptide chain is broken by three release factors. (RF 1, RF 2 and RF 3) and GTP. The release is catalyzed by the peptidyl transferase enzyme, the same enzyme that forms the peptide bonds. The ribosome jumps off the mRNA chain at the stop codon and dissociates into its two subunits. The completed polypeptide (amino acid chain) becomes free in the cytoplasm.

The ribosomes and the tRNAs on release from the mRNA can function again in the same manner and result in the formation of another polypeptide of the same protein.

### **Modification of Released Polypeptide**

The just released polypeptide is a straight, linear exhibiting a primary molecule, structure. It may lose some amino acids from the end with the help of a peptidase enzyme, and then coil and fold on itself to acquire secondary and tertiary structure. It may even combine with other polypeptides, to have quaternary structure.

The proteins synthesized on free polysomes are released into the cytoplasm and function as structural and enzymatic proteins. The proteins formed on the polysomes attached to ER pass into the ER channels and are exported as cell secretions by exocytosis after packaging in the Golgi apparatus.

### **Polysome Formation**

When the ribosome has moved sufficiently down the mRNA chain towards 3' end, another ribosome takes up position at the initiator codon of mRNA, and starts synthesis of a second molecule of the same polypeptide chain. At any given time, the mRNA chain will, therefore, carry many ribosomes over which are similar polypeptide chains of varying length, shortest near the initiator codon and longest near the terminator codon. A row of ribosomes joined to the mRNA molecule, is called a polyribosome, or a polysome. Synthesis of many molecules of the same polypeptide simultaneously from one mRNA molecule by a polysome is called translational amplification.

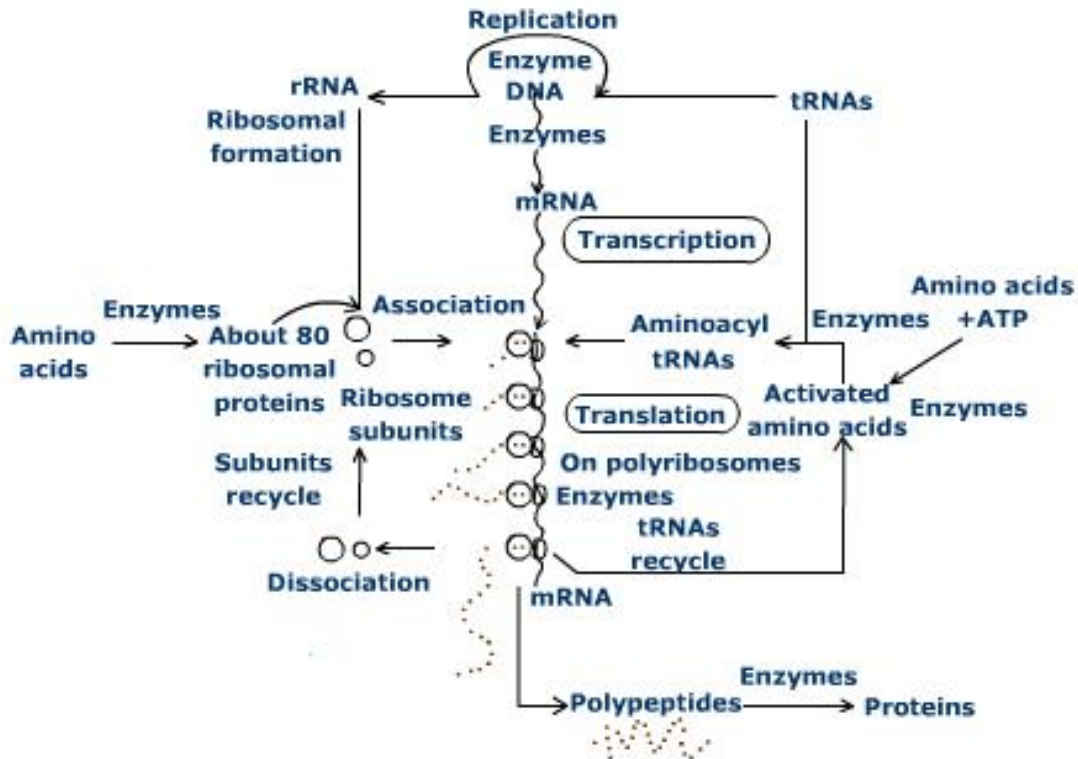

### Energy Used for Protein Synthesis

One GTP is hydrolysed to GDP as each successive amino acid-tRNA complex attaches to the A site of the ribosome. A second GTP is broken down to GDP as the ribosome moves to each new codon in the mRNA. One ATP is hydrolysed to AMP during amino acid activation. Thus, the formation of each peptide bond uses 3 high-energy molecules, one ATP and two GTP.

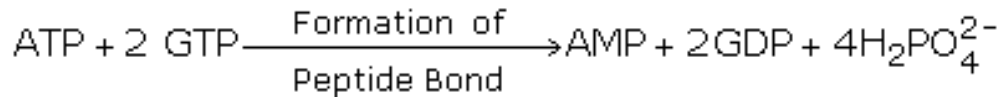

An interesting aspect of protein synthesis is that the DNA and ribosomes are located at different sites in the cell. Location of instruction centre (DNA) and manufacturing centre (ribosomes) at different sites in a cell is advantageous. If both were in the nucleus, the manufacturing centre would be far away from the energy sources and raw materials; and if both were in the cytoplasm, the information centre would be exposed to respiratory breakdown. The nuclear

envelope preserves stability of the DNA by protecting it from respiratory destruction. The message in the DNA in the form of genes (codes) are, permanent, authentic master documents from which working copies are prepared in the form of mRNAs, as and when required by the cell.

The complex process by which the information in RNA is decoded into a polypeptide is one of the exciting discoveries the genetic code

With only four biochemical letters (A, G, C, U) a one letter code could not unambiguously encode 20 amino acids. A two letter code could encode only 16 amino acids. So, a triplet code based on 3 biochemical letters or nucleotide bases could make  $4 \times 4 \times 4 = 64$  codons. This will be required to code for 20 or so different amino acids.

The discovery of the genetic code became possible through the contribution of many scientists like Francis Crick, Severo Ochoa, Maxell Ninenberg, Hargobind Khorana and J. H. Malther in the 1960s. Ninemberg and Khorana shared the Nobel Prize in 1968.

### **Characteristics of Genetic Code**

**The genetic code is a triplet code:** Three adjacent bases, termed as codon, specify one amino acid

**Non-overlapping:** Adjacent codons do not overlap

**No punctuation:** The genetic code is comma less

The genetic code is universal i.e., a given codon specifies the same amino acid in all protein synthesising organisms

The genetic code is degenerate: it lacks specificity and one amino acid often has more than one code triplet

Each codon codes for only one amino acid, none for more than one

Three of the 64 codons, names UAA, UAG and UGA do not specify any amino acid but signal the end of the message. They are called nonsense or terminator codons

The codons AUG and GUG are called the initiation or start codons as they begin the synthesis of polypeptide.

		MIDDLE LETTER									
		U	C	A	G						
FIRST LETTER (5' END)	U	UUU	Leucine	UCU	Serine	UAU	Tyrosine	UGU	Cysteine	U C A G	
		UUC		UCC		UAC		UGC			
		UUA		UCA		UAA*		UGA*			Trypto - phan
		UUG		UCG		UAG*		UGG			
	C	CUU	Leucine	CCU	Proline	CAU	Histidine	CGU	Arginine	U C A G	
		CUC		CCC		CAC		CGC			
		CUA		CCA		CAA		CGA			
		CUG		CCG		CAG		CGG			
	A	AUU	Isoleu - cine	ACU	Threonine	AAU	Asparagine	AGU	Serine	U C A G	
		AUC		ACC		AAC		AGC			
		AUA		ACA		AAA		AGA			Arginine
		AUG†		ACG		AAG		AGG			
	G	GUU	Valine	GCU	Alanine	GAU	Aspartic acid	GGU	Glycine	U C A G	
		GUC		GCC		GAC		GGU			
		GUA		GCA		GAA		GGA			
		GUG†		GCG		GAG		GGG			

In the above figure, the sequence of nucleotides in the triplet codons of RNA is indicated; each triplet specifies a particular amino acid.



**CROSSING OVER - FACTORS AFFECTING IT****Crossing over**

Genetic recombination crossing over is the mutual exchange of the corresponding parts of the adjacent paternal and maternal chromatids of the pachytene of meiosis I, producing new combinations of genes. The chromatids resulting from the interchange of segments are known as the cross over recombinants and the chromatids that remain intact are called non-crossover parental chromatids.

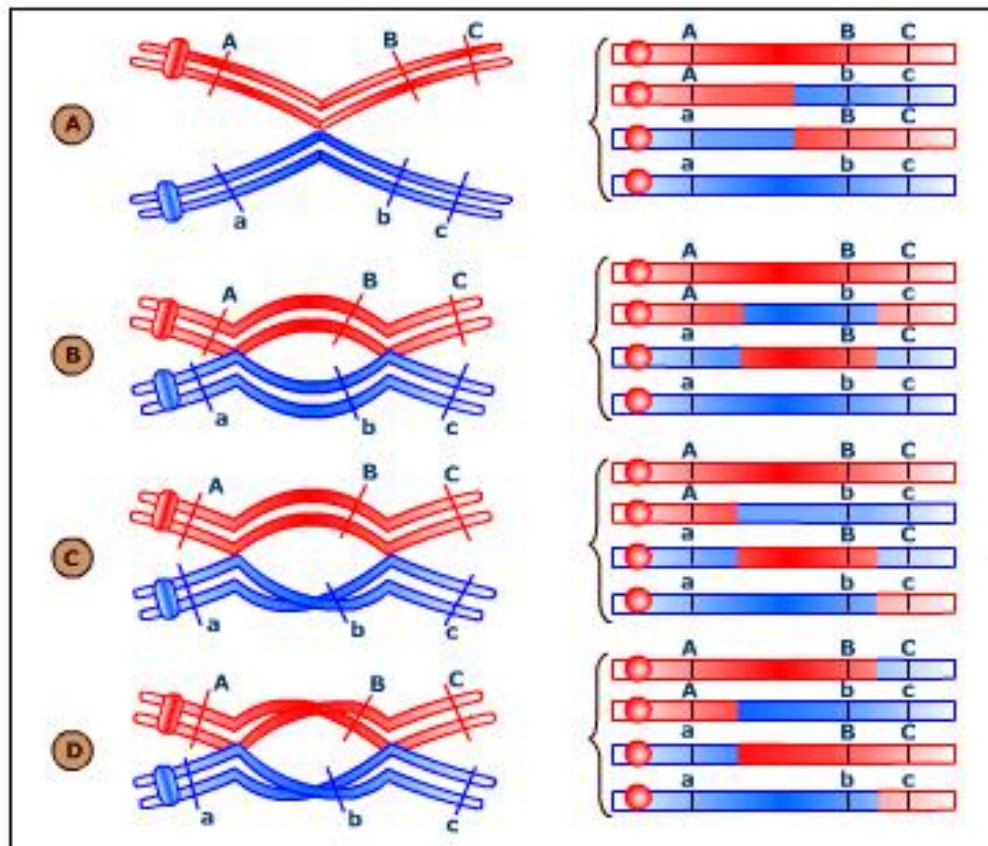

A :Single Crossing, B :Reciprocal Double Crossing Over, C and D: Complementary Double Crossing Over

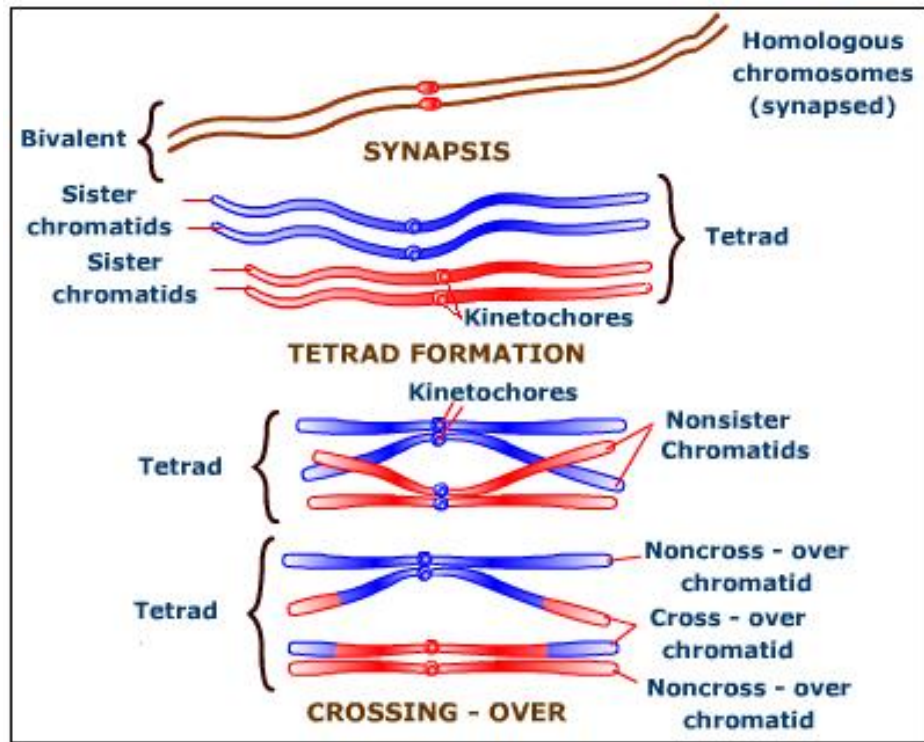

**It produces 50% parental and 50% recombinant chromatids**

### **Significance of Crossing Over**

- It produces new individuals having new combinations of traits.
- Crossing over has helped in establishing the concept of linear arrangement of genes.
- The frequency of crossing over helps in the mapping of chromosomes. i.e., determining the location of the genes in the chromosomes.
- Selection of useful recombination by geneticists has brought about green revolution in our country.

### **Stern's *Drosophila* Experiments**

In 1931, a few weeks after publication of similar experiments by Creighton and McClintock in *Zea mays* Stern reported work with *Drosophila*.



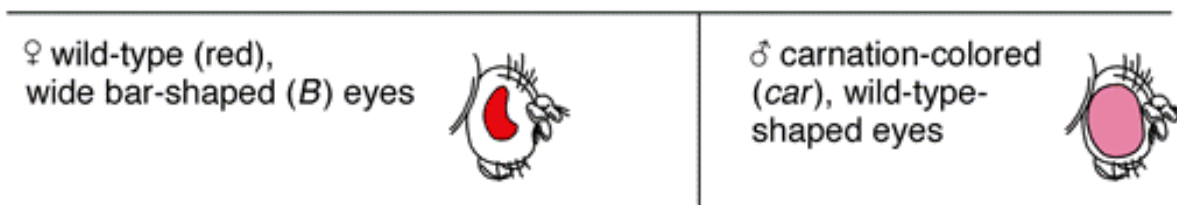

There are 2 Linked traits: carnation eye and bar-eye flies. Carnation is recessive, bar-eye is dominant. In *B/B* homozygotes, the eye is very narrow. In *B/+* heteros, get "wide-bar".

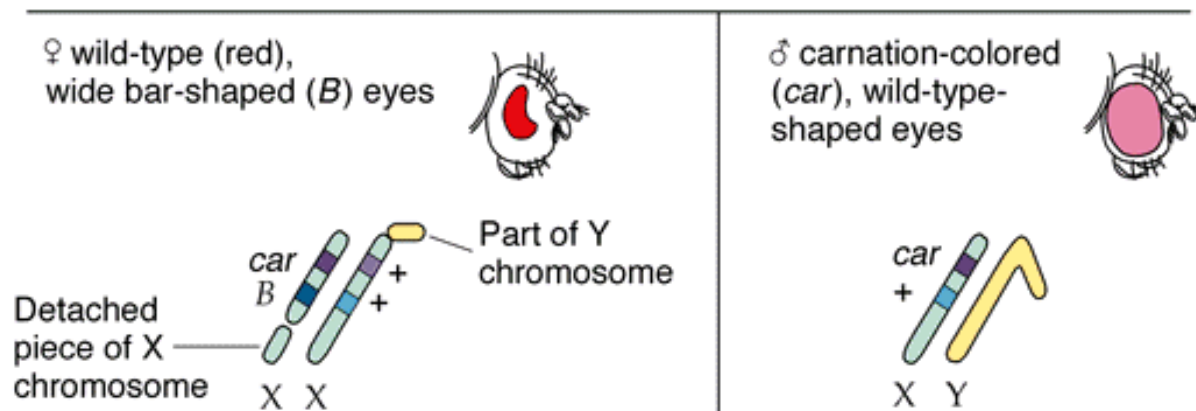

Male had normal X chromosome, *car* +/Y and Female had 2 cytologically distinct X chromosomes. One X had a portion of the Y chromosome attached to it, making it longer than normal. This one was wild type for both genes. The other X was shorter than normal, and had the *car* and *B* alleles on it.

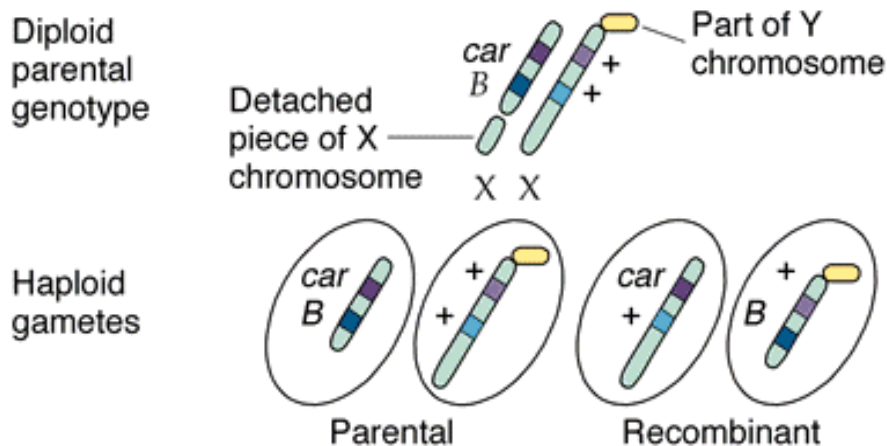
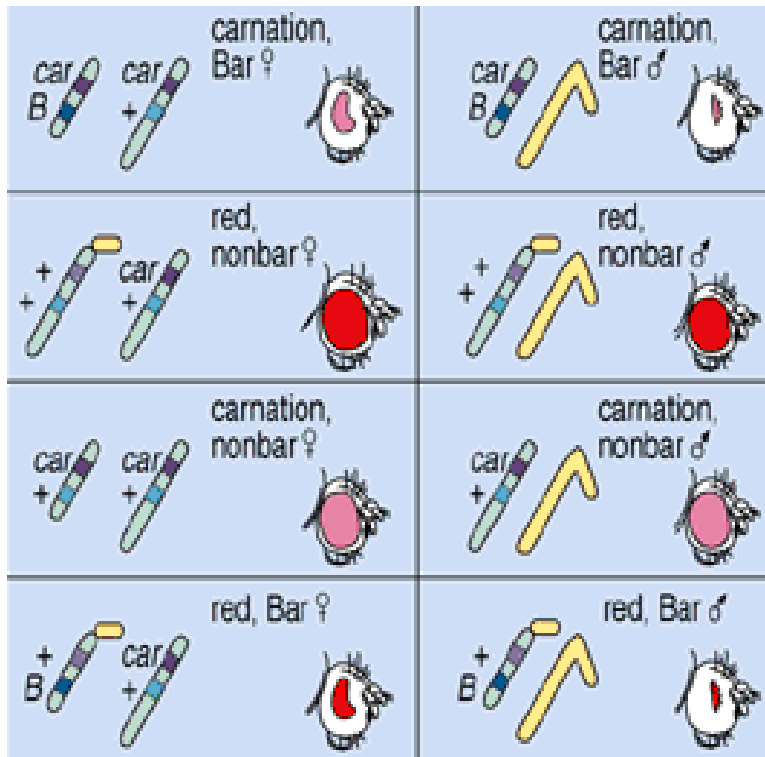

The observed results require the above types of gametes to be produced by females. The key observation was that in every case of genetic recombination, there had also been recombination of the cytological features. The same type of results had been found in the corn experiments. Genetic recombination (phenotypes of the offspring) was always accompanied by recombination of the cytological features. Together, these two studies convinced the field of genetics that

physical exchange of chromosome segments was the basis for recombination of linked genes.

BUT, when did the crossing-over take place. Remember, at the start of meiosis, the homologues are already replicated, and already paired up. So, one plausible model is that crossing-over actually takes place during interphase, before replication. That is, when each chromosome pair would consist of 2 chromatids, not 4 (not the tetrad stage).

How to distinguish between the two models?

To distinguish between the two models **a right model organism**  
***Neurospora crassa* (a bread mold) was selected.**

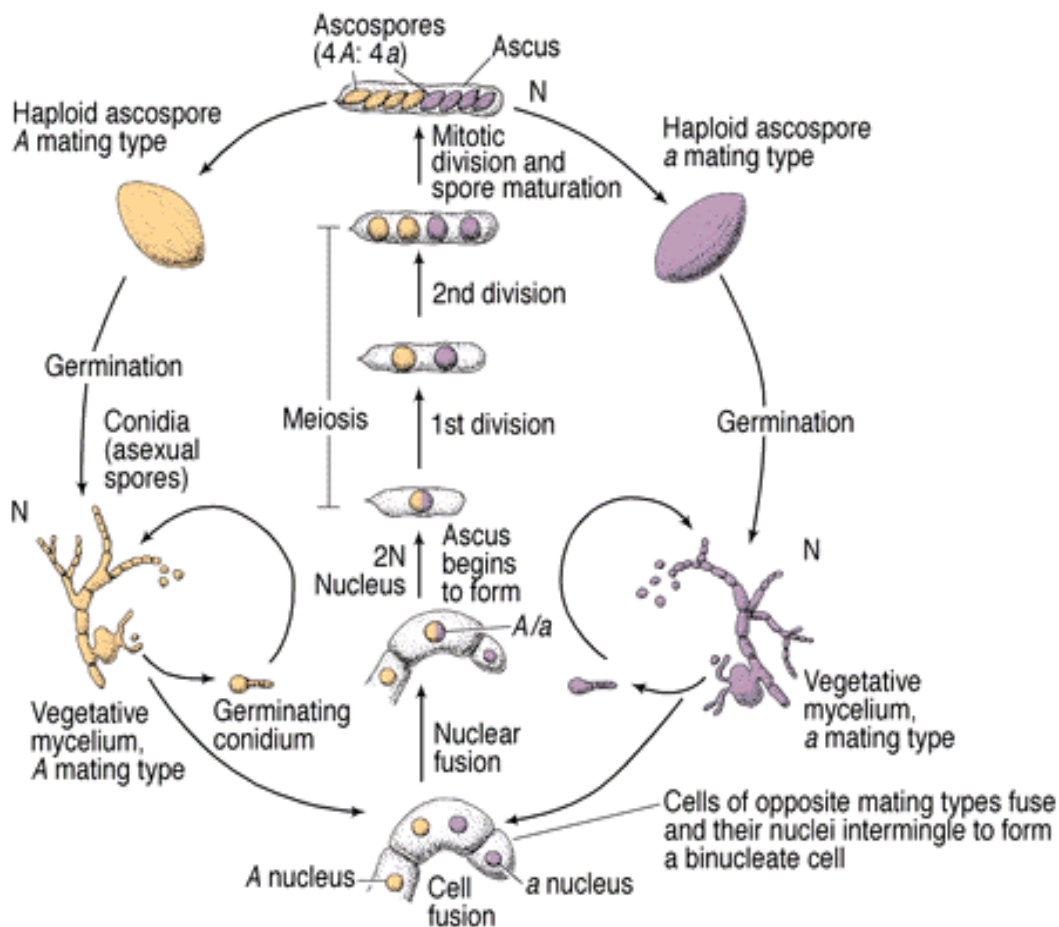

Normally, it reproduces asexually and also sexually. There are two mating types: A and a . The 2 haploid nuclei fuse to give a diploid nucleus, the only diploid

phase to this life cycle. Meiosis produces 4 haploid spores within an ascus. Subsequent mitotic division produces 8 haploid, sexual ascospores in a linear arrangement. All the products of a single meiosis are found together in the ascus. and, the order of the 4 spore pairs is the same as the order of the 4 chromatids of each tetrad during Metaphase I. By capitalizing on the biology of our model organism, we can now rigorously test our 2 competing hypotheses: Does crossing over take place during the 2-chromatid phase, or during the 4-chromatid phase?

To test, we need strains with mutations at 2 genes on the same chromosome. In *Neurospora*, there are many nutritional mutants are known. These are unable to make some essential nutrient on their own, and it must be supplied in their medium. *met* mutants are unable to synthesize their own methionine. *his* mutants are unable to synthesize their own histidine.

(a) Production of progeny spores if crossing-over occurs at two-chromatid stage prior to meiosis

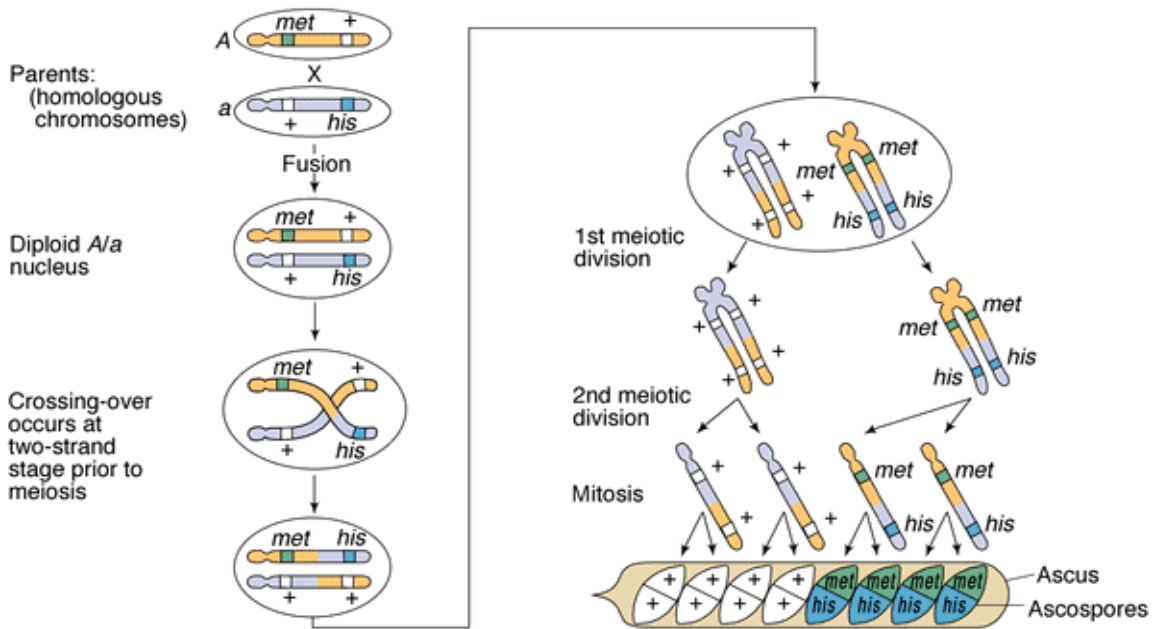

All spores are recombinants.

**(b) Production of progeny spores if crossing-over occurs at four-chromatid stage of meiosis**

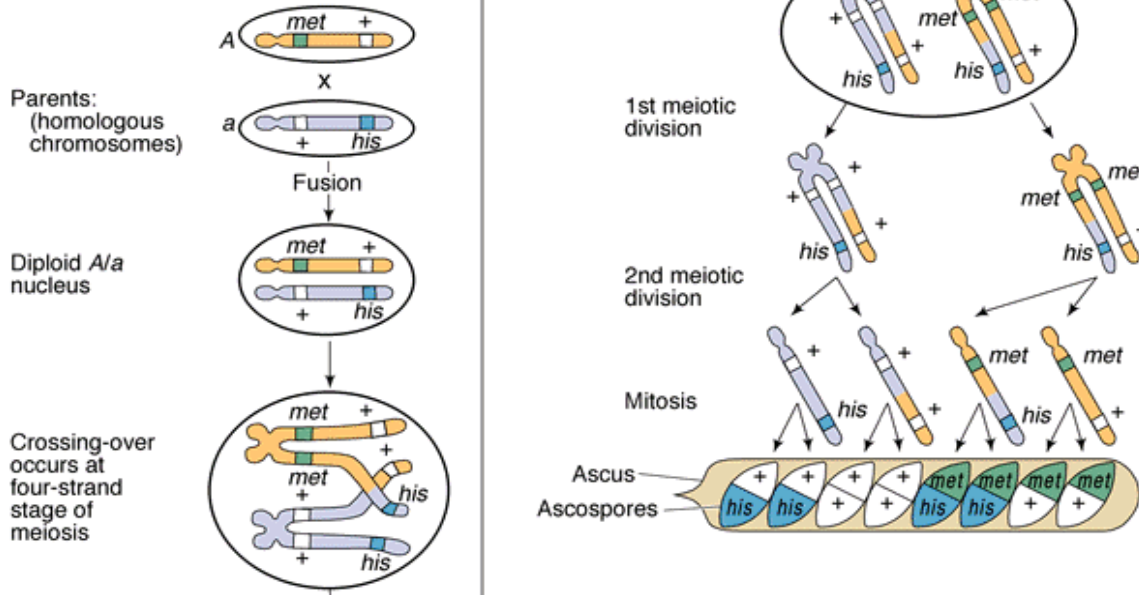

Note: 1/2 are parental, 1/2 are recombinant. Repeated experiments like this have shown that we get the second type of result. I.e., crossing over takes place at the tetrad stage (4 chromatids). They also show that the exchange is reciprocal: equal amounts of the 2 chromosomes are swapped.

**CHROMOSOME MAP**

**( Linkage map / Cross over map / Genetic map)**

The chromosome map may be defined as a line, on which the genes are represented by points, separated by distances proportional to the amount of crossing over.

The chromosome maps are also referred to as cross over maps since they are sketched by the amount of crossing over.

The percentage of crossing over is directly proportional to the distance of the alleles showing crossing over in the chromosome.

The chromosomes maps are the graphic representation of the genes in a chromosome.

The percentage of crossing over is calculated by test crosses. In mapping the genes, a unit of distance is used and it is called as **map unit** or **Morgan unit**.

The first chromosome map was made in 1911 by **Sturtevant** and soon after additional maps were made by **Bridges** and others.

*Drosophila* is the earliest material used by the scientists, for constructing maps.

### **Procedure for the chromosome mapping**

In fact genes are plotted on the chromosome on the basis of crossing over results between different pairs of linked genes. The actual distance between two genes is said to be equivalent to the percentage of crossing over between these genes.

When the % of crossing over between two genes is 5, then the distance is 5 units. For example five genes A, B, C, D and E are to be plotted on a chromosome. If cross over results indicate that genes A and E have the highest percentage of crossing over, it means that these should be placed at the maximum distance.

In this example, the gene A can be taken as a starting point in the chromosome and can be represented by O.

Now if the gene A and B exhibit 7% crossing over, the gene B can be placed on the chromosome at a distance of 7 units.

If the gene C shows 8% crossing over with gene B and about 15% crossing over with gene A, it can be plotted on the chromosome at a distance of 15 units from gene A.

Similarly if gene A and E exhibit 20% and 30% crossing over with gene D and 5% and 10% with gene C these, are located on the chromosome 5 and 10 units away from the gene C respectively.

### **Construction of Chromosome map in *Drosophila***

In *Drosophila* the chromosome map is constructed with the help of test cross. In *Drosophila* grey colour is dominant over black colour; and the long wing is dominant over vestigial wing.

The  $F_1$  female hybrid is **test crossed**. Four types of individuals are formed. Out of four types, two types are parental type (G:L & B:V) and other two are non parental type (G:V & B:L) due to crossing over. Non – parental type is 17%. So the percentage of crossing over is equivalent to 17%. The distance between the two genes (G-L) is equivalent to the percentage of crossing over or percentage of non parental combination. So the distance between the gene G & L is equivalent to 17 morgan units.

Percentage of non parental combination = 17%

So the percentage of crossing over = 17

So the distance between the Gene G & L = 17 map unit

In another experiment the  $F_1$  female grey red is test crossed with black cinnabar. The experiment shows 9% non parental combination individuals. So the distance between the Gene G & Cn is equivalent to 9 map unit.

In the same way the  $F_1$  female red long is test crossed with cinnabar vestigial. The experiment shows 9.5% non-parental combination individuals. So the distance between the gene Cn is equivalent to 9.5 map unit.

According to the first experiment the distance between G & L is equivalent to 17 map unit. But the second and third experiment show 18.5 map units between the two genes. To find out the actual reason for this difference in the distance, conduct a 3 point cross.

### Three Point cross

In the three point cross all the three pairs of genes are considered in the experiment. The  $F_1$  hybrid female is test crossed. They produce 8 different types of individuals. Out of 8 types, two types are parental. Remaining six are non-parental.

# Principles of Genetics

	Male		Female
Parent :	Grey Red Long		Black cinnabar Vestigial
	G Cn L	x	<u>g cn l</u>
	Y-chromosome		g cn l
			Normal
F <sub>1</sub> :			<u>G Cn L</u>
			g cn l
Back cross :	Female		Male
	Normal		Recessive
	<u>G Cn L</u>	x	<u>g cn l</u>
	g cn l		Y – chromosome

## F<sub>2</sub> Offspring

Parental combinations due to linkage = 658 = 82.25%

Non parental combination : Single cross over :

a) Between G and Cn

	<u>g Cn L</u>	= 36	
1. Black red long	g cn l	}	= 70
2. Grey cinnabar vestigial	<u>G cn l</u>	}	= 34
	g cn l		

b) Between Cn and L

1. Grey red vestigial    G Cn l



## Principles of Genetics

$$\begin{array}{r}
 g\ cn\ l = 35 \\
 \left. \vphantom{g\ cn\ l} \right\} \\
 \text{2. Black cinnabar long } \underline{g\ cn\ L} = 31 \\
 \left. \vphantom{g\ cn\ L} \right\} = 66 \\
 g\ cn\ l
 \end{array}$$

Double cross over

$$\begin{array}{r}
 \text{1. Grey cinnabar long } \underline{G\ cn\ L} = 4 \\
 \left. \vphantom{G\ cn\ L} \right\} \\
 g\ cn\ l \\
 \left. \vphantom{g\ cn\ l} \right\} = 6 \\
 \text{2. Black red vestigial } \underline{g\ Cn\ l} = 2 \\
 g\ cn\ l
 \end{array}$$

$$\text{Total c.o between G and Cn} = 70 + 6 = 76 = 9.5\%$$

(includes double c.o)

$$\text{Total c.o between Cn and L} = 66 + 6 = 72 = 9.0\%$$

(includes double c.o)

$$\text{Total c.o. between G and L} = 76 + 72 = 148 = 18.5\%$$

(includes double c.o)

$$\text{C.o between G and E} = 70 + 66 = 136 = 17\%$$

(double c.o not included)

From these results, it is concluded that the gene cinnabar lies about half – way between the genes for black body colour and vestigial wings. The total amount of crossing over between black body and vestigial wing is 18.5% rather than the 17% expected on the basis of the first cross. The discrepancy (18.5 – 17 = 1.5) just noted, arises because of the occurrence of double crossing over, that is, of two cross overs occurring simultaneously in the same cell between these two loci.

As a final check on these results, it would be well to make a trihybrid or three point cross using all three pairs of genes at once. When pure recessive flies are crossed with normal flies, all the  $F_1$  flies are normal phenotypically. When the  $F_1$  females are back crossed to triple recessive males, eight phenotypes are obtained.

From the data obtained the relative position of the genes can be calculated. The distance between G and Cn is 9 units, the distance between Cn and L is 9.5 units; the L gene could be to the right of Gn locus or to the left. If the first order (CnL) is correct, then the distance between G and L is 17 units. This small discrepancy is due to double crossing over. Based upon the above data, the three genes can be mapped as follows :

### **Chromosome Maps of Drosophila**

The chromosome maps of Drosophila include four linkage groups corresponding to four chromosome pairs. The genes present in the X chromosome constitute the first linkage group, those present in 2<sup>nd</sup> and 3<sup>rd</sup> chromosome constitute 2<sup>nd</sup> and 3<sup>rd</sup> linkage groups and those on the fourth chromosome form fourth linkage group. The fourth linkage group is the smallest of all.

### **Chromosome maps of maize**

Chromosome maps of maize have been drawn by R.A. Emerson. As there are 10 pairs of chromosome 10 chromosome maps are seen.

### **Factors affecting the mapping**

Chromosome map can be constructed only with the help of crossing over percentage. The crossing over percentage is highly modified by the interference and coincidence.

### **Interference**

Normally the double crossing over frequency is very low. Because the crossing over and chiasma formation in the homologous non sister chromatids interferes with the crossing over and chiasma formation at other points nearby. This is called as **interference**. This was discovered by Muller (1911). The interference is **inversely proportional** to the crossing over percentage. The

interference is maximum over a short distance and decreases as the distance increases.

### **Coincidence**

The coincidence is an inverse measure of interference. It is measured as a ratio between actual number of double cross overs and the expected number of double cross overs.

Actual number of double cross overs

Coincidence =  $\frac{\text{Actual number of double cross overs}}{\text{Expected number of double cross overs}}$

If the actual number of double cross overs is zero, then coincidence is zero and interference is complete. If the actual number of double cross overs is the same as the expected number, coincidence is said to be one, and interference is nil. It ranges from 0 to 1.

**LINKAGE - TYPES OF LINKAGE AND ESTIMATION OF LINKAGE.****LINKAGE**

Every individual organism bears several heritable characters which are represented by the innumerable genes present on the chromosomes. During meiosis, the chromosomes move into the gametes as units, all the genes present on any given chromosome will segregate as a group and move together from generation to generation. This tendency of the genes located on the same chromosome, to stay together in hereditary transmission, is known as linkage. The genes located on the same chromosome are called linked genes.

The principle of linkage was discovered by Bateson and Punnett in 1906 in the sweet pea, plant, *Lathyrus odoratus*. However, linkage, as a concept was put forth by Thomas Hunt Morgan in 1910 based on his experiment on *Drosophila melanogaster*.

**Chromosome Theory of Linkage**

Morgan, along with Castle formulated the chromosome theory of linkage. It has the following postulates;

1. Genes are found arranged in a linear manner in the chromosomes.
2. Genes which exhibit linkage are located on the same chromosome.
3. Genes generally tend to stay in parental combination, except in cases of crossing over.
4. The distance between linked genes in a chromosome determines the strength of linkage. Genes located close to each other show stronger linkage than that are located far from each other, since the former are less likely to enter into crossing over.

**Linkage Groups**

All the genes located on a particular chromosome, form a linkage group. Since, the genes present on a particular chromosome have their alleles located on its homologous chromosome, genes on a pair of homologous chromosomes. Hence, the number of linkage groups corresponds to the number of haploid chromosomes found in a species.

*Drosophila melanogaster* has four linkage groups which can be distinguished into three large and one small linkage groups corresponding to the four pairs of

chromosomes. Twenty-three linkage groups are present in humans corresponding to 23 pairs of chromosomes.

Pea plant has seven linkage groups, corresponding to the seven pairs of chromosomes.

**Linkage in maize**

'C' for coloured aleurone is dominant over 'c' colourless

Sh for Full endosperm is dominant over 'sh' shrunken.

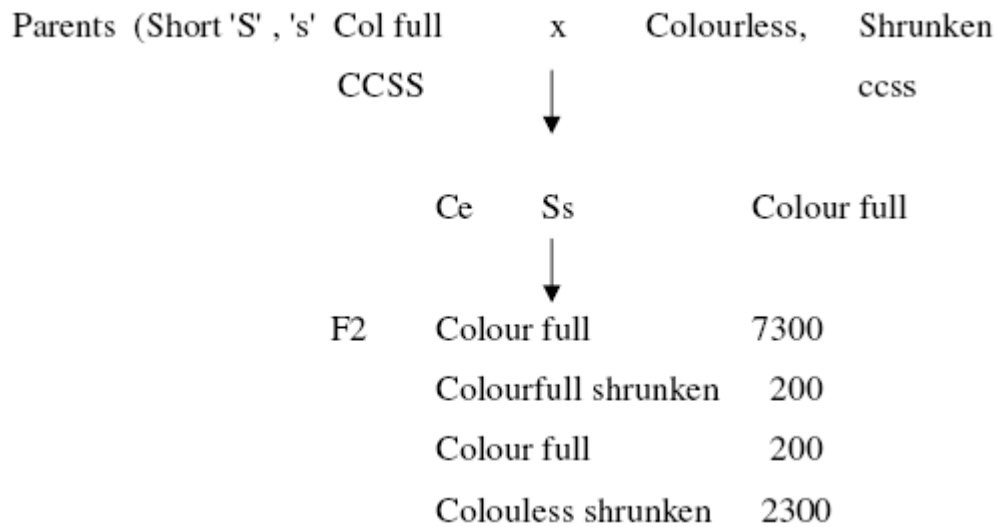

F2 did not show 9: 3: 3: 1 ratio. There were greater number of colour full, colour shrunken (parental types) than colourfull shrunken , colour full, If two character considered separately,they segregate 3 : 1

i.e . Colour - 7500

Full - 7500

Colouless - 2500

Shrunken - 2500

The large deviation of the observed F2 population form the excepted segregation is therefore not because the members of each pair of alleles do not segregate from each other but because of the separation in one pair of alleles is not independent of the separation in the other pair of alleles.

**Test cross**

	Colour full	x	Colourless shrunken
	CCSS		eess
F1	CeSs	x	eess
F2	F2	Colour full	4800
		Col. Shrunken	200
		Col. Less full	200
		Col less shrunken	4800

The data show that, the two pairs of genes have not assorted independently.

**Segregation of two pairs of genes on two pairs of chromosomes**

Let us suppose that, gene 'C' is located on chromosome number 9 and 'S' on chromosome number 10 of maize. The segregation of chromosome bearing C and c is entirely independent of segregation of chromosome bearing S and s. So four type of gametes Cs, Cs, eS, eS are formed in F1 and F2 normal dihybrid ratio 9:3:3:1 and test cross 1:1:1:1

**Segregation for two pairs of genes on one pair of chromosomes**

Let us suppose that, two genes C and S are located on chromosome No. 9 during meiosis only 2 gametes will be formed Cs and cs gametes. So, Genes C and S situated on same chromosomes are said to be linked. Linkage is the association of character in inheritance due to fact that genes determining them are physically located on the same chromosomes.

**Detection of Linkage**

Compare the number of individuals observed in each class with those expected on the basis of independent assortment and then to test the deviation between these two values by chi-square test.

**Linkage Group**





### Linkage studies revealed the following

1. Genes that assort at random are non linked genes. Genes that do not segregate at random are linked genes.
2. Linked genes are arranged in a lines fashion on the chromosome. Each linked gene has a definite and constant order in its arrangement.
3. The distance between the linked genes determines the degree of strength of linkage. Closely located genes show stronger linkage that the widely located genes.
4. Linked genes do not always stay together, but are often exchanged reciprocally by cross over.

### Complete Linkage

The genes closely located in the chromosome show complete linkage as they have no chance of separating by crossing over and are always transmitted together to the same gamete and the same offspring. Thus, the parental combination of traits is inherited as such by the young one.

### Incomplete Linkage

The genes distantly located in the chromosome show incomplete linkage because they have a chance of separation by crossing over and of going into different gametes and offspring.

### Importance of linkage in breeding

When there is a close linkage between desirable and undesirable characters these genes are inherited in blocks and not individually and recombination is practically nil. In such cases linkage has to be broken by ' irradiation'.

### Linked Genes on the Same Chromosome Exhibit Distorted Mendelian Ratios

It was not long from the time that Mendel's work was rediscovered that new anomalous ratio began appearing. One such experiment was performed by Bateson and Punnet with sweet peas. They performed a typical dihybrid cross between one pure line with purple flowers and long pollen grains and a second pure line with red



flowers and round pollen grains. Because they knew that purple flowers and long pollen grains were both dominant, they expected a typical 9:3:3:1 ratio when the F<sub>1</sub> plants were crossed. The table below shows the ratios that they observed. Specifically, the two parental classes, purple, long and red, round, were over represented in the progeny.

	Observed	Expected
Purple, long (P_L_)	284	215
Purple, round (P_ll)	21	71
Red, long (ppL_)	21	71
Red, round (ppll)	55	24
<b>Total</b>	<b>381</b>	<b>381</b>

At the time of these experiments, Bateson and Punnett were not able to develop an acceptable hypothesis. The best explanation they posed was that in some manner the phenotypic classes (alleles) in the parents were **coupled**, and they did not sort independently into gametes as predicted by Mendel's second law.

Proof those genes on the same chromosome can at times be inherited as blocks awaited the results of Thomas Hunt Morgan with *Drosophila*. Morgan crossed red eye, normal wing flies ( $pr^+pr^+ vg^+vg^+$ ) with purple eye, vestigial wing ( $prpr vgv$ ) flies. The figure below shows the cross and the F<sub>1</sub> genotypes. (The bars are used to show that the genes reside on the same chromosome.) During meiosis, four different F<sub>1</sub> gametes are produced. The **parental gametes** are developed without any processing. The **recombinant gametes** though occur by a process called **crossing over**. (The X between the two F<sub>1</sub> chromosomes represents the crossing over event.)

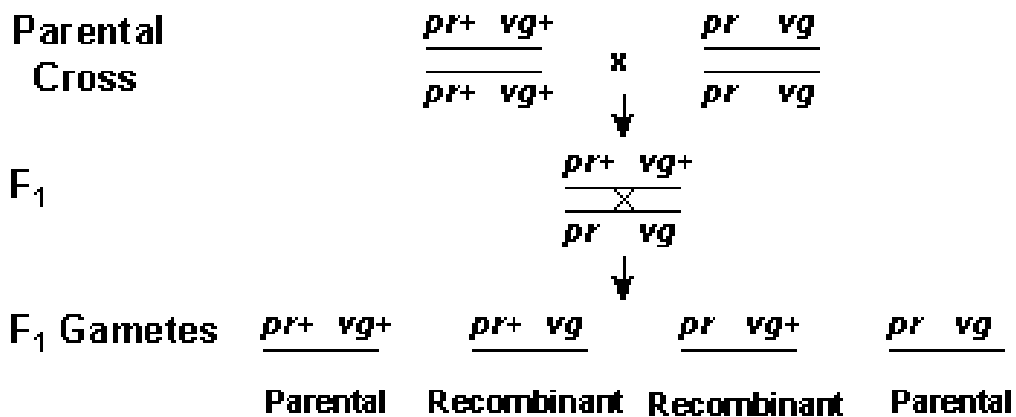

Morgan performed a testcross by crossing  $prpr \quad vgv$  flies to F<sub>1</sub>. The testcross is powerful because it allows you to follow the meiotic events in one parent because all of the gametes from the test cross parent are homozygous recessive. For this example, the testcross genotype is  $pr \quad vg$ . Therefore the testcross progeny will represent the distribution of the gametes in the F<sub>1</sub>. Remember that a testcross to F<sub>1</sub> derived from a dihybrid cross gave a 1:1:1:1 ratio. But this is not what Morgan observed. The following table shows the result of this test cross.

F <sub>1</sub> Gamete	Testcross Distribution	Gamete Type
$pr^+ \quad vg^+$	1339	Parental
$pr^+ \quad vg$	151	Recombinant
$pr \quad vg^+$	154	Recombinant
$pr \quad vg$	1195	Parental

These results confirm the Bateson and Punnett hypothesis that two genes do not always assort independently. A further confirmation experiment was performed by Morgan when he crossed red eye, vestigial wing flies and purple eye, normal wing flies. Whereas in the first cross, the two dominant alleles and two recessive alleles were on the same chromosome the F<sub>1</sub>, in the is cross a dominant allele was on the same chromosome as a recessive allele. The term for the first chromosomal arrangement of the F<sub>1</sub> is called **coupling**, whereas the second arrangement is called **repulsion**. Another set of terms to describe these arrangements are **cis** and

**trans**, respectively. The following shows the chromosomal arrangement for the cross of two parents in repulsion.

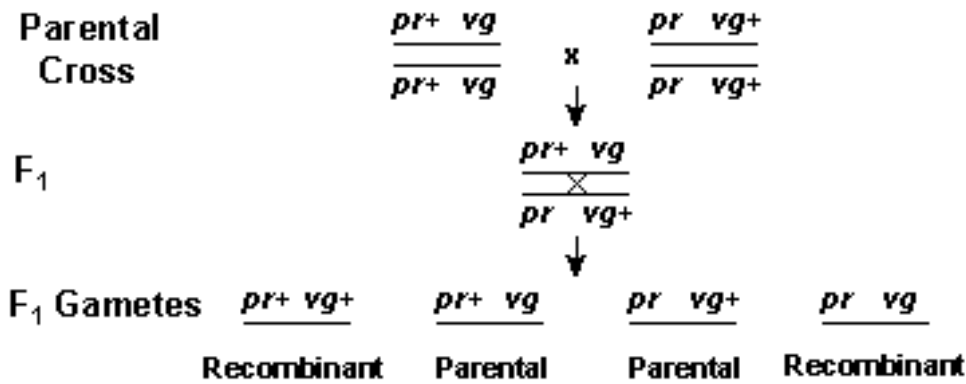

As with the first cross, Morgan test crossed these F<sub>1</sub> flies. The following table shows the distribution of these F<sub>1</sub> gametes.

F <sub>1</sub> Gamete	Testcross Distribution	Gamete Type
<i>pr<sup>+</sup> vg<sup>+</sup></i>	157	Recombinant
<i>pr<sup>+</sup> vg</i>	965	Parental
<i>pr vg<sup>+</sup></i>	1067	Parental
<i>pr vg</i>	146	Recombinant

It was expected that both the coupling and repulsion crosses would yield 1:1:1:1 ratios. How can we determine if the results deviate from this ratio. As with any ratio, we can use the chi-square test to determine if the observed results fit or deviate from the expected ratio. The two tables below show the results for the chi-square for the two crosses.

**Coupling Cross Chi-Square Test**

F <sub>1</sub> Gamete	Observed	Expected	(O-E) <sup>2</sup> /E
<i>pr<sup>+</sup> vg<sup>+</sup></i>	1339	709.75	557.9
<i>pr<sup>+</sup> vg</i>	151	709.75	439.9
<i>pr vg<sup>+</sup></i>	154	709.75	435.2
<i>pr vg</i>	1195	709.75	331.8

<b>Total</b>	<b>2839</b>	<b>2839</b>	<b><math>\chi^2 = 1764.8</math></b>
--------------	-------------	-------------	-------------------------------------

**Repulsion Cross Chi-Square Test**

<b>F<sub>1</sub> Gamete</b>	<b>Observed</b>	<b>Expected</b>	<b>(O-E)<sup>2</sup>/E</b>
<i>pr<sup>+</sup> vg<sup>+</sup></i>	157	583.75	312.0
<i>pr<sup>+</sup> vg</i>	965	583.75	249.0
<i>pr vg<sup>+</sup></i>	1067	583.75	483.3
<i>pr vg</i>	146	583.75	328.3
<b>Total</b>	<b>2335</b>	<b>2335</b>	<b><math>\chi^2 = 1372.6</math></b>

It is quite clear that both of these large chi-square values indicate that neither of these ratios fit the 1:1:1:1

## NUMERICAL MUTATIONS (POLYPLOIDY)

Mutations which alter the chromosome structure, size or gene arrangement are chromosomal mutations. Chromosomal mutations are widely called as chromosomal aberrations. These are grouped into two broad classes based on whether they alter the structure or number of chromosomes.

Chromosome Mutations - gross changes in chromosomes.

### Changes in the number of chromosomes.

**1. Euploidy** - variation in the number of sets of chromosomes.

**a. Haploidy (Monoploidy)** - one set of chromosomes ( $n$ ) : ABC

**b. Polyploidy**-three or more sets of chromosomes.

**c. Triploidy**-3 sets of chromosomes ( $3n$ ) : ABC, ABC, ABC.

**d. Tetraploidy**-4 sets of chromosomes ( $4n$ ): ABC, ABC, ABC, ABC.

**e. Pentaploidy**-5 sets of chromosomes ( $5n$ ) : ABC, ABC, ABC, ABC, ABC.

**f. Hexaploidy** ( $6n$ ), **Septaploidy** ( $7n$ ), **Octoploidy** ( $8n$ ), etc

**2. Aneuploidy** - variation in the number of chromosomes of a set. (Reduction in the normal number of chromosomes. )

**a. Monosomics** - Loss of one chromosome ( $2n-1$ ) : ABC, AB.

**b. Double monosomics** - Loss of 2 different chromosomes ( $2n-1-1$ ): ABC, A.

b - loss of a pair of homologous chromosomes ( $2n-2$ ) : AB, AB:

b. Increase in the number of chromosomes (polysomies).

**Trisomies** - presence of 1 extra chromosome ( $2n+ 1$ ) : ABC, ABC, A.

**Double trisomics** - 2 different extra chromosomes ( $2n + 1 + 1$ ) : ABC, ABC, AB.

**Tetrasomics** - an extra pair of homologous chromosomes ( $2n+2$ ): ABC, ABC, AA.

**pentasomics** ( $2n+3$ ), **Hexasomics** ( $2n+4$ ), **Sepiasomics** ( $2n+5$ ), etc. **Euploidy**

The term euploidy (Gr., eu-true or even; ploid-unit) designates genomes containing whole sets of chromosomes. The euploids are those organisms which contain balanced set or sets of chromosomes or genomes in any number, in their body cells. The euploidy is of following types: The number of chromosomes in a basic set is called the **monoploid number** ( $x$ ). Organisms with multiples of the monoploid number of chromosomes are called euploid. Eukaryotes normally carry either one chromosome set (haploids) or two sets (diploids). Haploids and diploids,

then, are both cases of normal euploidy. Euploid types that have more than two sets of chromosomes are called polyploid.

### **Polyploidy**

Humans are diploid creatures, meaning for every chromosome in our body, there is another one to match it.

- Haploid creatures have one of each chromosome
- Diploid creatures have two of each chromosome
- Triploid creatures have three of each chromosome
- Polyploid creatures have three or more of each chromosome

They can be represented by  $n$  where  $n$  equals haploid,  $2n$  equals diploid and so on. It is possible for a species, particularly plant species, to produce offspring that contains more chromosomes than its parent. This can be a result of non-disjunction, where normally a diploid parent would produce diploid offspring, but in the case of non-disjunction in one of the parents, produces a polyploid.

In the case of triploids, although the creation of particular triploids in species is possible, they cannot reproduce themselves because of the inability to pair homologous chromosomes at meiosis, therefore preventing the formation of gametes. Polyploidy is responsible for the creation of thousands of species in today's planet, and will continue to do so. It is also responsible for increasing genetic diversity and producing species showing an increase in size, vigour and an increased resistance to disease.

The polyploid types are named triploid ( $3x$ ), tetraploid ( $4x$ ), pentaploid ( $5x$ ), hexaploid ( $6x$ ), and so forth. Polyploids arise naturally as spontaneous chromosomal mutations. However, many species of plants and animals have clearly arisen through polyploidy, so evidently evolution can take advantage of polyploidy when it arises. It is worth noting that organisms with one chromosome set sometimes arise as variants of diploids; such variants are called monoploid ( $1x$ ). In some species, monoploid stages are part of the regular life cycle, but other monoploids are spontaneous aberrations.

The haploid number ( $n$ ), which we have already used extensively, refers strictly to the number of chromosomes in gametes. In most animals and many plants with which we are familiar, the haploid number and monoploid number are

the same. Hence,  $n$  or  $x$  (or  $2n$  or  $2x$ ) can be used interchangeably. However, in certain plants, such as modern wheat,  $n$  and  $x$  are different. Wheat has 42 chromosomes, but careful study reveals that it is hexaploid, with six rather similar but not identical sets of seven chromosomes. Hence,  $6x=42$  and  $x=7$ . However, the gametes of wheat contain 21 chromosomes, so  $n=21$  and  $2n=42$ .

### **Monoploids**

In monoploidy, the monoploid organisms have one genome ( $n$ ) in their body cells. When monoploidy occurs in gametes (sperms and eggs) it is termed as haploidy. Most micro-organisms (e.g., bacteria, fungi and algae); gametophytic generation of plants (e.g., bryophytes and other plants); sporophytic generation of some higher angiospermic plants (e.g., Sorghum, Triticum, Hordeum, Datura, etc.) and certain hymenopteran male insects (e.g., wasps, bees, etc.) have one genome in their body cells, hence are monoploids. Monoploids are usually smaller and less vigorous than their diploid prototypes. Characteristically, monoploid plants are sterile. The reason of sterility is that the chromosomes have no regular pairing partners (homologous chromosomes) during meiosis, and meiotic products are deficient in one or more chromosomes. For instance, a haploid in maize ( $2n=20$ ) will have 10 chromosomes and the number of chromosomes in a gamete can range from 0-10. Consequently, considerable sterility will be found in a monoploid maize.

Male bees, wasps, and ants are monoploid. In the normal life cycles of these insects, males develop parthenogenetically—that is, they develop from unfertilized eggs. However, in most species, monoploid individuals are abnormal, arising in natural populations as rare aberrations. The germ cells of a monoploid cannot proceed through meiosis normally, because the chromosomes have no pairing partners. Thus, monoploids are characteristically sterile.

Monoploids play an important role in modern approaches to plant breeding. Diploidy is an inherent nuisance when breeders want to induce and select new gene mutations that are favorable and to find new combinations of favorable alleles at different loci. New recessive mutations must be made homozygous before they can be expressed, and favorable allelic combinations in heterozygotes are broken up by meiosis. Monoploids provide a way around some of these problems. In some plant species, monoploids can be artificially derived from the products of meiosis in a

plant's anthers. A cell destined to become a pollen grain can instead be induced by cold treatment to grow into an embryoid, a small dividing mass of cells. The embryoid can be grown on agar to form a monoploid plantlet, which can then be

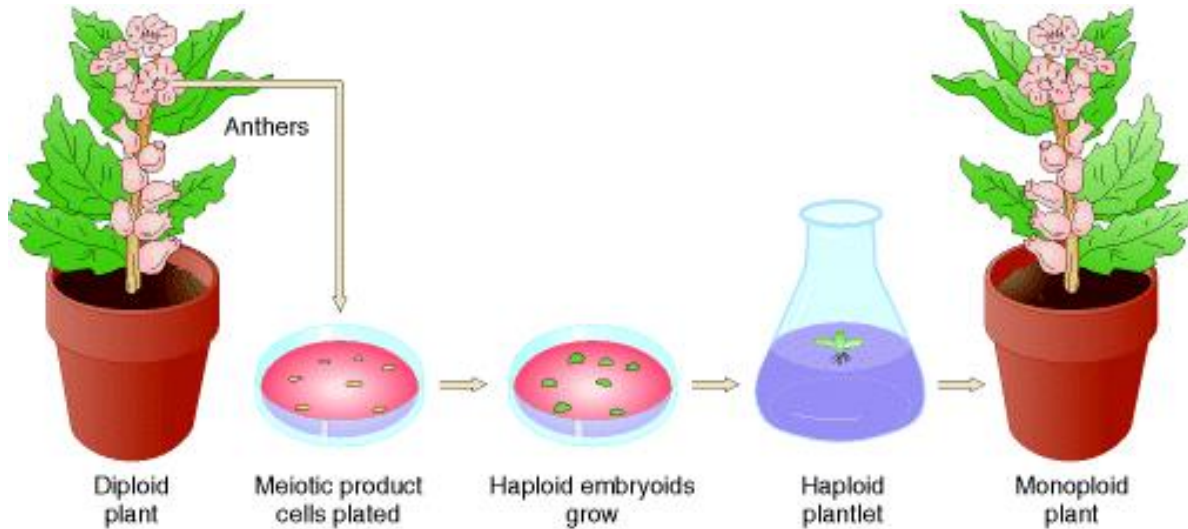

potted in soil and allowed to mature.

**Figure a.** Generating monoploid plants by tissue culture. Pollen grains (haploid) are treated so that they will grow and are placed on agar plates containing certain plant hormones. Under these conditions, haploid embryoids will grow into monoploid plantlets. After having been moved to a medium containing different plant hormones, these plantlets will grow into mature monoploid plants with roots, stems, leaves, and flowers.

Plant monoploids can be exploited in several ways. In one, they are first examined for favorable traits or allelic combinations, which may arise from heterozygosity already present in the parent or induced in the parent by mutagens. The monoploid can then be subjected to chromosome doubling to achieve a completely homozygous diploid with a normal meiosis, capable of providing seed. It is achieved by the application of a compound called colchicine to meristematic tissue. **Colchicine**—an alkaloid drug extracted from the autumn crocus - inhibits the formation of the mitotic spindle, so cells with two chromosome sets are produced. These cells may proliferate to form a sector of diploid tissue that can be identified cytologically.



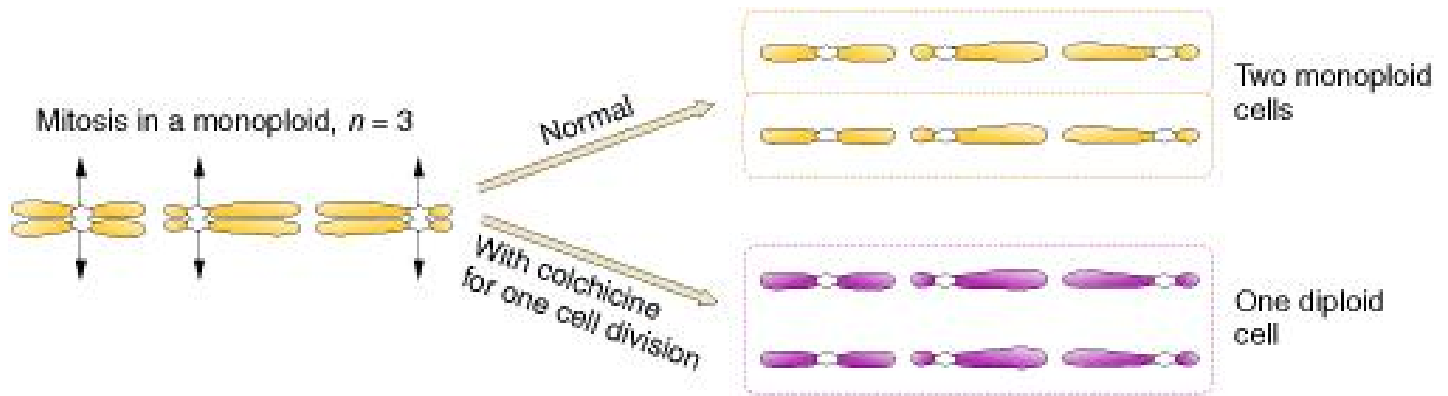

**Figure b.** The use of colchicine to generate a diploid from a monoploid. Colchicine added to mitotic cells during metaphase and anaphase disrupts spindle-fiber formation, preventing the migration of chromatids after the centromere is split. A single cell is created that contains pairs of identical chromosomes that are homozygous at all loci.

Another way in which the monoploid may be used is to treat its cells basically like a population of haploid organisms in a mutagenesis-and-selection procedure. A population of cells is isolated, their walls are removed by enzymatic treatment, and they are treated with mutagen. They are then plated on a medium that selects for some desirable phenotype. This approach has been used to select for resistance to toxic compounds produced by one of the plant's parasites and to select for resistance to herbicides being used by farmers to kill weeds. Resistant plantlets eventually grow into haploid plants, which can then be doubled (with the use of colchicine) into a pure-breeding, diploid, resistant type.

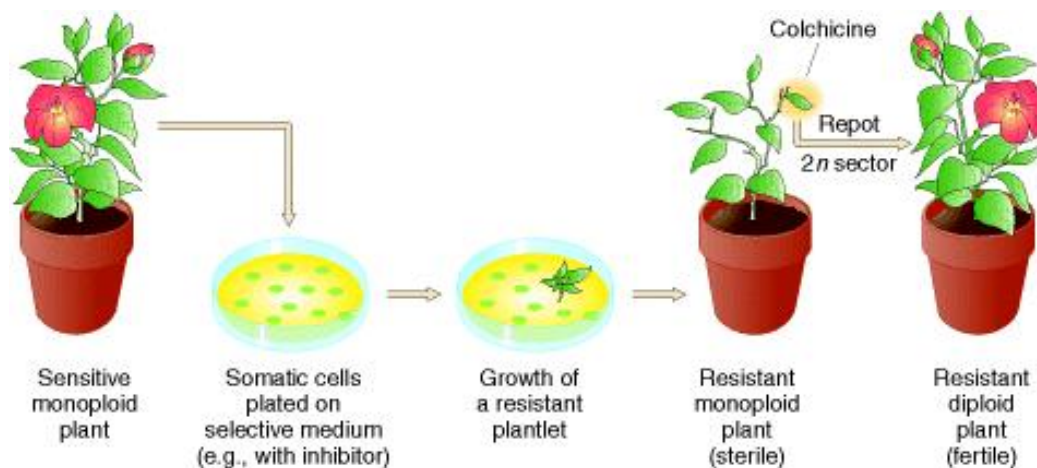

**Figure c.** Using microbial techniques in plant engineering. The cell walls of haploid cells are removed enzymatically. The cells are then exposed to a mutagen and plated on an agar medium containing a selective agent, such as a toxic compound

produced by a plant parasite. Only those cells containing a resistance mutation that allows them to live within the presence of this toxin will grow. After treatment with the appropriate plant hormones, these cells will grow into mature monoploid plants and, with proper colchicine treatment, can be converted into homozygous diploid plants.

These powerful techniques can circumvent the normally slow process of meiosis-based plant breeding. The techniques have been successfully applied to several important crop plants, such as soybeans and tobacco.

The anther technique for producing monoploids does not work in all organisms or in all genotypes of an organism. Another useful technique has been developed in barley, an important crop plant. Diploid barley, *Hordeum vulgare*, can be fertilized by pollen from a diploid wild relative called *Hordeum bulbosum*. This fertilization results in zygotes with one chromosome set from each parental species. In the ensuing somatic cell divisions, however, the chromosomes of *H. bulbosum* are eliminated from the zygote, whereas all the chromosomes of *H. vulgare* are retained, resulting in a haploid embryo. (The haploidization appears to be caused by a genetic incompatibility between the chromosomes of the different species.) The chromosomes of the resulting haploids can be doubled with colchicine. This approach has led to the rapid production and widespread planting of several new barley varieties, and it is being used successfully in other species too.

### **Diploidy**

The diploidy is characterized by two genomes ( $2n$ ) in each somatic cell of the diploid organisms. Most animals and plants are diploids. The diploidy is related with fertility, balanced growth, great vigorosity, adaptability and survivality of the diploid organisms

### **Polyploids**

The organisms with more than two genomes are called polyploids. Among plants and animals, the polyploidy occurs in a multiple series of 3, 4, 5, 6, 7, 8, etc., of the basic chromosome or genome number and thus is causing triploidy, tetraploidy, pentaploidy, hexaploidy, heptaploidy, octaploidy, respectively. Ploidy levels higher than tetraploid are not commonly encountered in natural populations, but our most important crops and ornamental flowers are polyploid, e.g., wheat (hexaploid,  $6n$ ), strawberries (octaploid,  $8n$ ), many commercial fruit and

ornamental plants, liver cells of man, etc. Other examples of polyploidy among plants and animals are following:

### **A: Examples of polyploidy in plants**

The polyploidy is most common among angiosperms and some of economically important polyploid angiospermic plants are peanuts (*Arachis*), oats (*Avena*), coffee (*Coffea*), strawberry (*Fragaria*), cotton (*Gossypium*), barely (*Hordeum*), sweet potato (*Ipomoea*), apple (*Malus*), alfa-alfa (*Medicago*), banana (*Musa*), tobacco (*Nicotiana*), plum (*Prunus*), sugar cane (*Saccharum*), potato (*Solanum*), sorghum (*Sorghum*), clover (*Trifolium*), and wheat (*Triticum*).

A continuous polyploid series has been reported in rose plant. Aeuploid series of basic number of 7 (monoploid) including diploids ( $2n = 14$ ), triploids (21), tetraploids (28), pentaploids (35), hexaploid (42), and octaploid (56) has been reported in different species of *Rosa*. Likewise, the genus *Chrysanthemum* has basic chromosome number 9 and has a euploidic series of diploid ( $2n = 18$ ), tetraploids ( $4n = 36$ ), hexaploids ( $6n = 54$ ), octaploids ( $8n = 72$ ) and decaploids ( $10n = 90$ ) in its different species.

The genus *Solanum* has basic chromosome number 12 and has a euploidic series of diploids ( $2n = 24$ ), triploids ( $3n = 36$ ), tetraploids ( $4n = 48$ ), pentaploids ( $5n = 60$ ), hexaploids ( $6n = 72$ ), octaploids ( $8n = 96$ ), and decaploids ( $10n = 120$ ) in its different species.

### **Origin of Polyploidy**

Different degrees of ploidy are originated by different means. However, two basic irregular processes have been discovered by which polyploids may evolve from diploid plants and become established in nature:

(1) Somatic doubling-cells sometimes undergo irregularities at mitosis and give rise to meristematic cells that perpetuate these irregularities in new generations of plants.

(2) Reproductive cells may have an irregular reduction or equational division in which the sets of chromosomes fail to separate completely to the poles at anaphase. Both sets thus become incorporated in the same nucleus resulting in the doubling of chromosome number in the gamete (see Gardner, 1912). Thus, a triploid originates

by the fusion of a haploid gamete ( $n$ ) with a diploid gamete ( $2n$ ), the later of which may be originated by irregularities during meiosis.

Likewise, a tetraploid may be originated by the somatic doubling of the chromosome number or by union of unreduced diploid gametes.

The somatic doubling of genome is accomplished either spontaneously or it can be induced in high frequency by exposure to chemicals such as colchicine, etc., or heat or cold. Other levels of polyploidy are also originated by same methods.

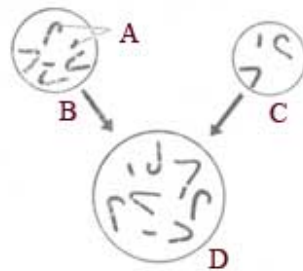

**A. Chromosomes B. Diploid gamete C. Haploid gamete D. Triploid zygote**

### Induction of Polyploidy

The polyploidy can be induced in common diploid organisms by following methods:

**1. Cell generation** - In certain bryophytes such as mosses, the polyploidy has been induced by cutting their diploid sporophytes and keeping the sporophytes in moist conditions. The cells of the cut ends regenerated threads which were true protonema and produced diploid gametophytic generation instead of monoploidic generation.

**2. Physical agents** - Following kinds of physical conditions induce polyploidy in plants:

**(i) Temperature shocks** - Extreme temperature changes some. times result in a higher frequency of polyploid cells.

**(ii) Centrifugation** - The centrifugation of seedlings of plants causes polyploidy in their cells. In *Nicotiana*, polyploidy has been induced by this method.

**(iii) X-rays** - The radioactive substances such as radium and X-rays have been found to induce polyploidy in normal diploid plant cells.

**3. Chemical agents** - Some chemicals such as colchicine, chloral hydrate, acenaphthene, veratrine, sulfanil amide, ethyl, mercury chloride. hexachlorocyclohexane have been reported to induce polyploidy in plants. These chemical substances when used to dividing diploid cells, they disturb the mitotic spindle and cause non-segregation of already duplicated chromosomes and thus, convert the diploid cells into tetraploid cells. The tetraploid cells, likewise, are converted into different levels of polyploidy

**Kinds of Polyploidy**

In the realm of polyploids, we must distinguish between **autopolyploids**, which are composed of multiple sets from within one species, and **allopolyploids**, which are composed of sets from different species. Allopolyploids form only between closely related species; however, the different chromosome sets are **homeologous** (only partly homologous)—not fully homologous, as they are in autopolyploids.

**Allopolyploidy**- The prefix "allo" indicates that nonhomologous sets of chromosomes are involved.

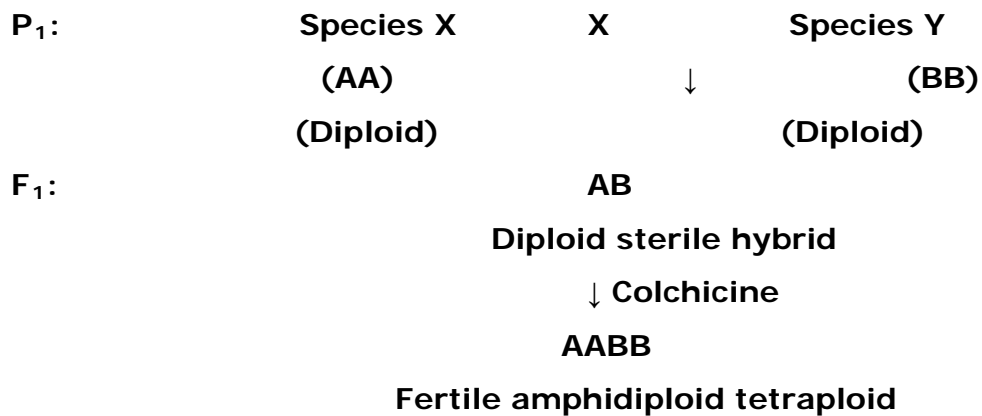

The union of unreduced or diploid or polyploid gametes from different diploid or polyploid species could produce in one step, an amphipolyploid or allopolyploid; which appears and behaves like a new species. Let A represent a set of genome in species X, and let B represent another genome in a species Y. The F<sub>1</sub> hybrids of these species than would have one A genome and another B genome. The F<sub>1</sub> diploid but sterile hybrids can be converted into fertile allotetraploids by treating them by colchicine.

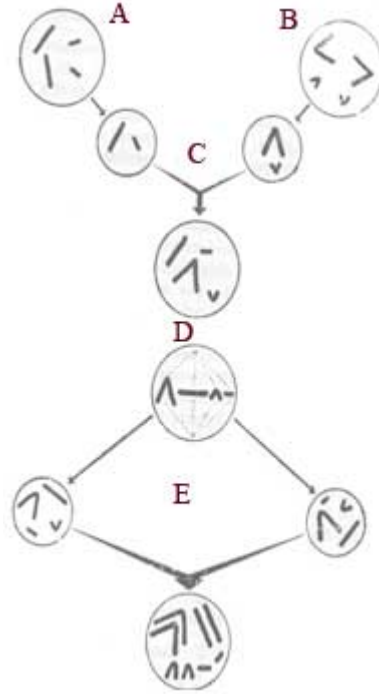

The Russian cytologist, G. D. Karpechenko (1928) first ore. , synthesized a allotetraploid genus called *Rhaphanobrassica* from the artificial crosses between vegetables belonging to different genera, the radish (*Raphanus satirum*,  $2n = 18$ ) and the cabbage (*Brassica oleracea*,  $2n = 18$ ). The F<sub>1</sub> hybrids were diploid and having the root of cabbage and leaves of radish. They were highly sterile because of failure of each set of chromosomes to provide sufficient genetic homology to affect pairing. Among these sterile F<sub>1</sub> hybrids, however, he found certain fertile allotetraploids which contained 36 chromosomes and were named as *Rhaphanobrassica*.

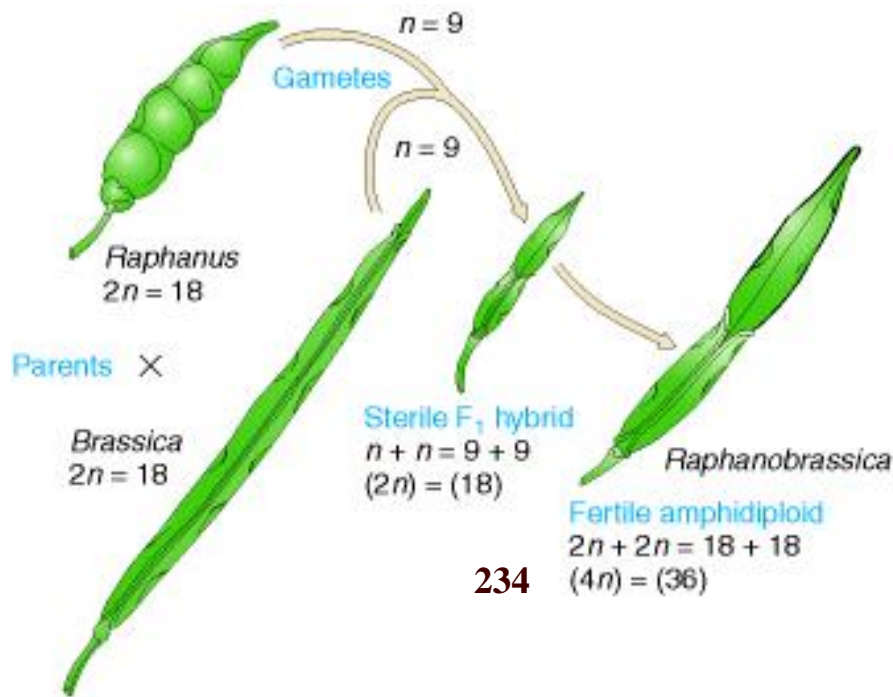

*Triticum spelta*, is a hexaploid wheat which was artificially synthesized in 1946 by E. S. McFadden and E. R. Sears and also by H. Kihara. They crossed an emmer wheat, *Triticum dicoccoides* (tetraploid:  $2n= 28$ ) with goat grass, *Aegilops squarrosa* (diploid;  $2n= 14$ ) and doubled the chromosome number in the F<sub>1</sub> hybrids. This artificially synthesized hexaploid wheat was found to be similar to the primitive wheat *T. spelta*. When the synthesized hexaploid wheat was crossed with naturally occurring *T. spelta*, the F<sub>1</sub> hybrid was completely fertile, this suggested that hexaploid wheat must have originated in the past due to natural hybridization between tetraploid wheat and goat grass followed by subsequent chromosome doubling.

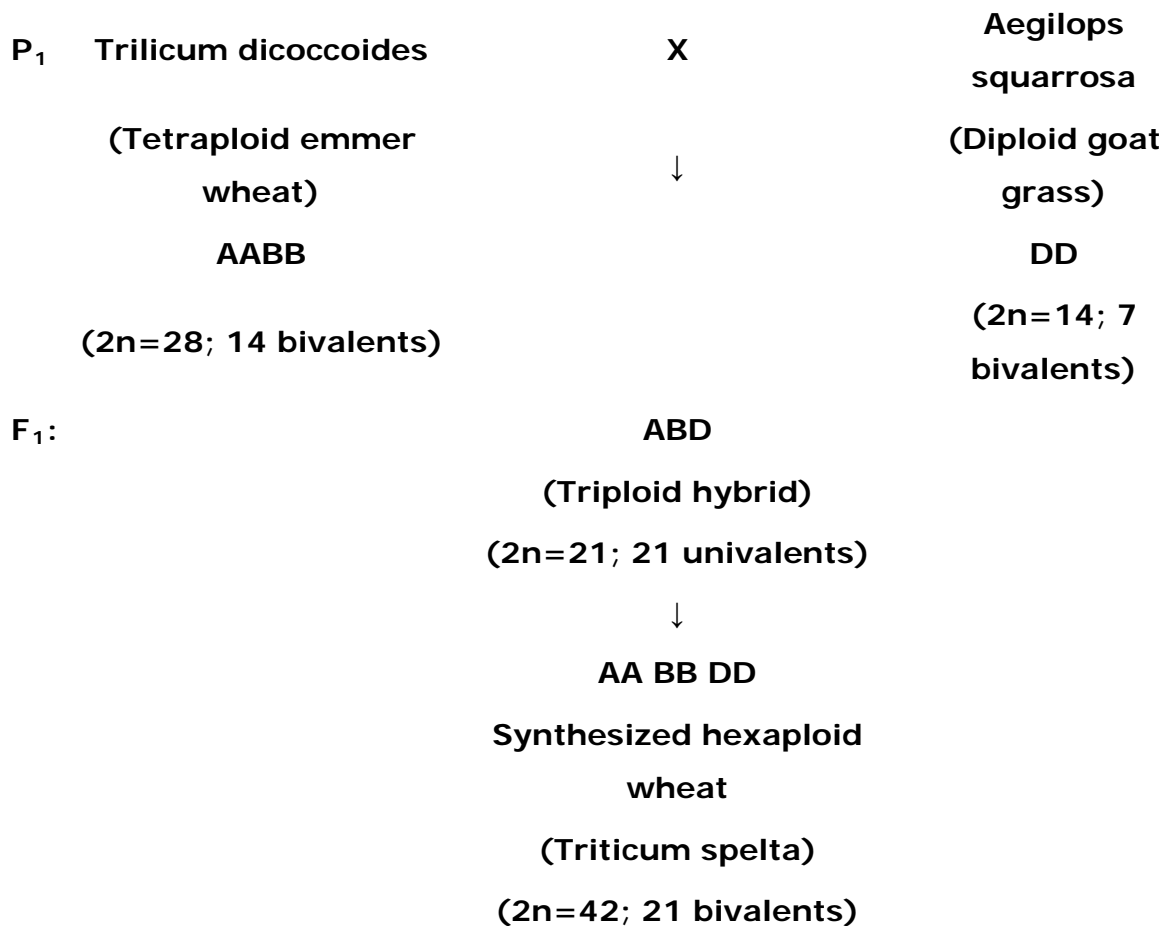

Another interesting case of allotetraploidy has been observed in the production of a rust resistant allotetraploid wheat plant. Common wheat plant, *Triticum vulgare* is susceptible to leaf rust, a serious disease caused by the fungus

*Puccinia triticina*. A wild grass of the Mediterranean region, *Aegilops umbellulata* is completely resistant to this disease. Sears (1956) have transferred the genes of rust resistance of *A. umbellulata* into *T. vulgare* genome by following method:

He crossed the plants of *A. umbellulata* with *T. dicoccoides* and got sterile hybrid which by treatment with colchicine was transformed into a rust-resistant, fertile allotetraploid having 21 pairs of chromosomes. The allotetraploid was crossed to *T. vulgare* and a fertile, rust-resistant hybrid was produced.

*Gossypium hirsutum*, the New world cotton plant, is another interesting example of allopolyploidy. Old world cotton, *Gossypium herbaceum*, has 13 pairs of chromosomes, while American or "upland cotton" also contains 13 pairs of chromosomes. J. O. Beasley crossed the old world and American cottons and doubled the chromosome number in the F<sub>1</sub> hybrids. The allopolyploids thus produced resembled the cultivated New world cotton and when crossed with it gave fertile F<sub>1</sub> hybrids. These results, thus, suggested that tetraploid *Gossypium hirsutum* originated from two diploid species, namely *G. herbaceum* ( $2n=26$ ) and *G. raimondii* ( $2n=26$ ).

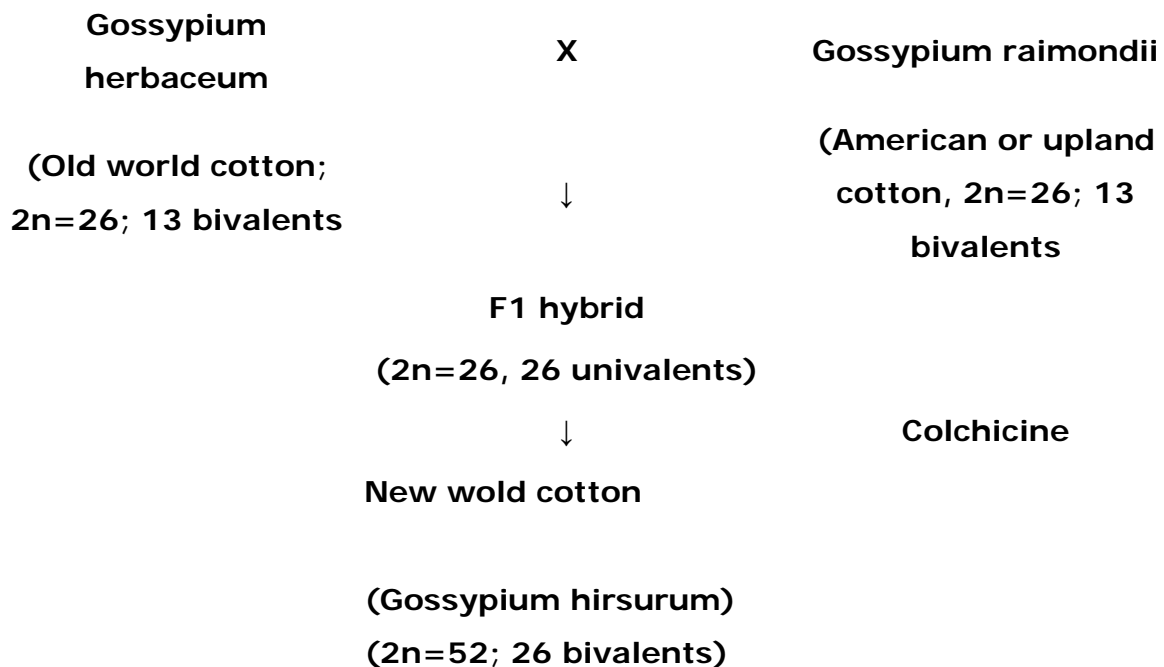

Today, allopolyploids are routinely synthesized in plant breeding. Instead of waiting for spontaneous doubling to occur in the sterile hybrid, the plant breeder adds colchicine to induce doubling. The goal of the breeder is to combine some of



the useful features of both parental species into one type. This kind of endeavor is very unpredictable, as Karpechenko learned. In fact, only one synthetic amphidiploid has ever been widely used. This amphidiploid is *Triticale*, an amphidiploid between wheat (*Triticum*,  $2n=6x=42$  and rye (*Secale*,  $2n=2x=14$  *Triticale* combines the high yields of wheat with the ruggedness of rye. The below figure shows the procedure for synthesizing *Triticale*.

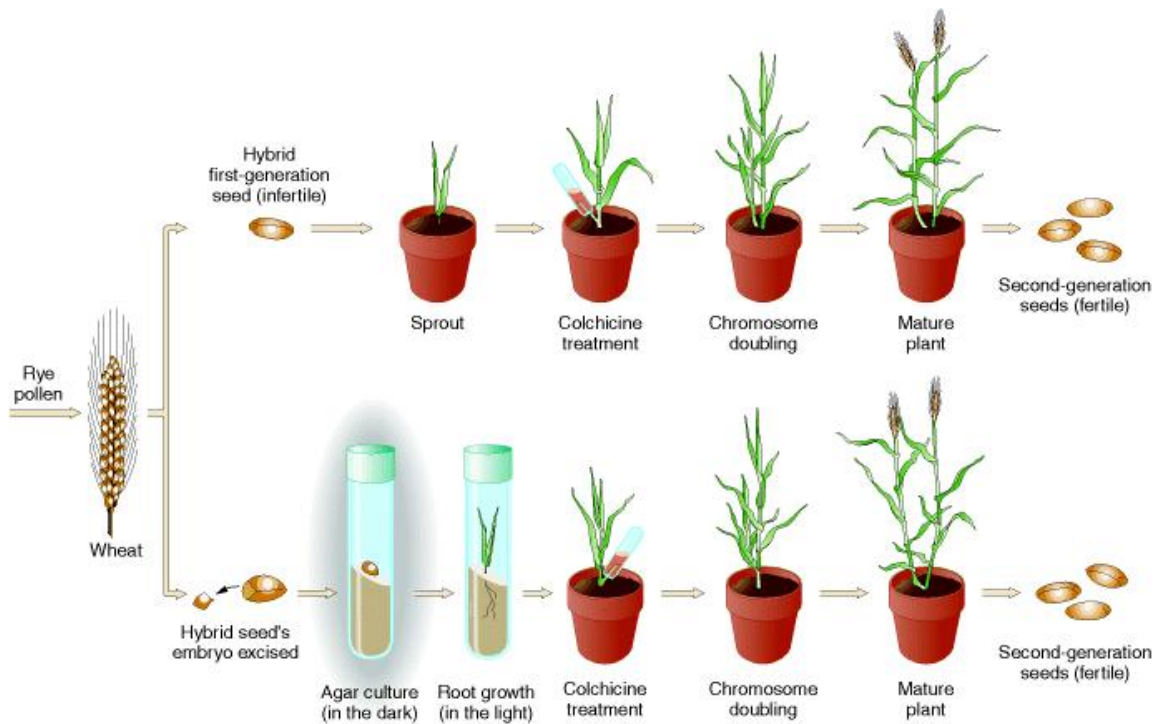

Figure 18-10. Techniques for the production of the amphidiploid *Triticale*. If the hybrid seed does not germinate, then tissue culture (*lower path*) may be used to obtain a hybrid plant.

In nature, allopolyploidy seems to have been a major force in speciation of plants. There are many different examples. One particularly satisfying one is shown by the genus *Brassica*, as illustrated in [Figure 18-11](#). Here three different parent species have hybridized in all possible pair combinations to form new amphidiploid species.

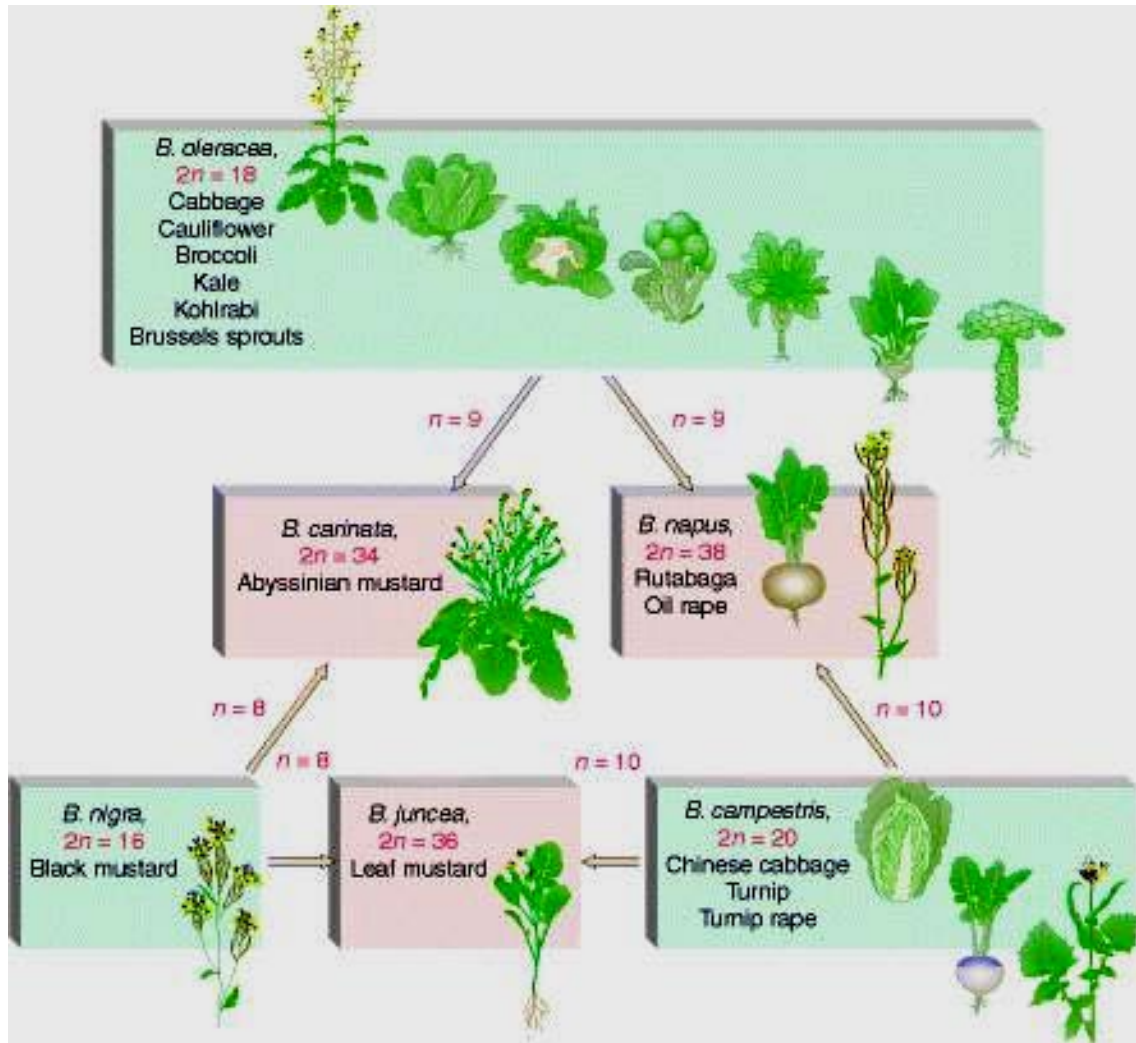

Figure 18-11. A species triangle, showing how amphidiploidy has been important in the production of new species of *Brassica*.

A particularly interesting natural allopolyploid is bread wheat, *Triticum aestivum* ( $2n=6x=42$ ). By studying various wild relatives, geneticists have reconstructed a probable evolutionary history of bread wheat ([Figure 18-12](#)).

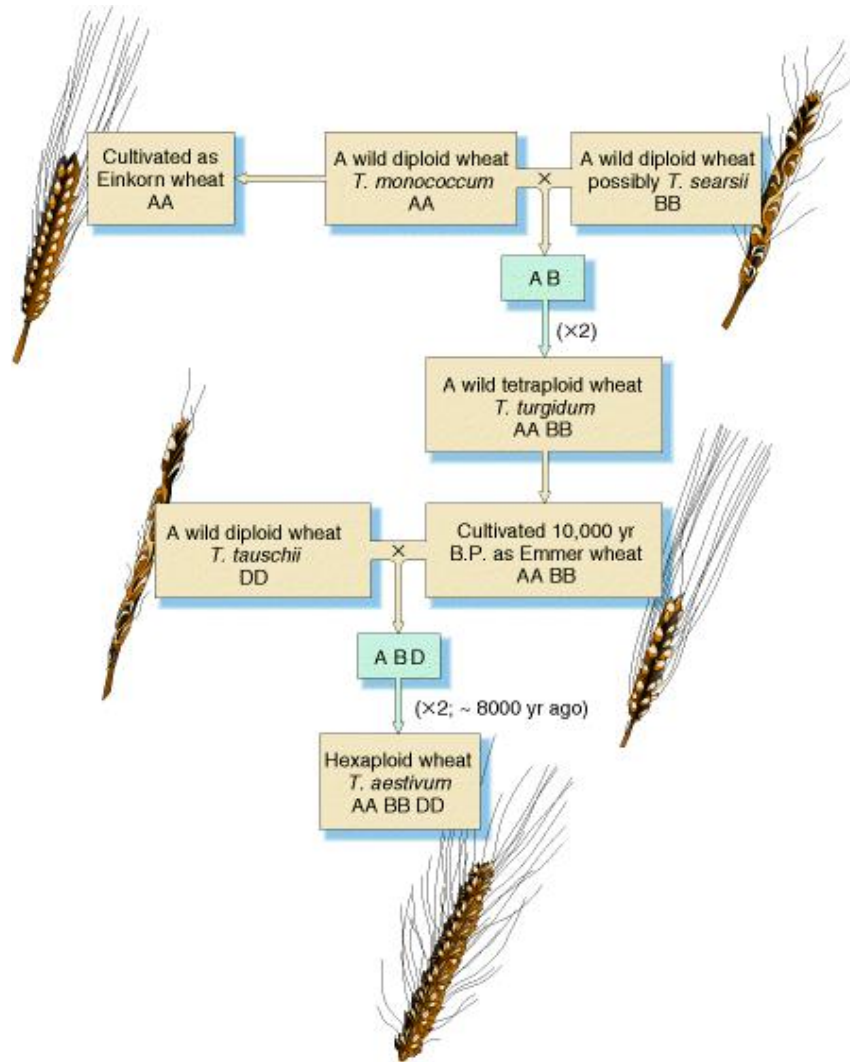

Figure 18-12. Diagram of the proposed evolution of modern hexaploid wheat, in which amphidiploids are produced at two points. A, B, and D are different chromosome sets

### Autopolyploids

The prefix "auto" indicates that the ploidy involves only homologous chromosome sets. Somatic doubling of a diploid produces four sets of genomes of a tetraploid and likewise, somatic doubling of a tetraploid produces eight sets of genomes of a octaploid. Union of unreduced diploid or tetraploid gametes from the same species would accomplish the same result. For example, if a diploid species has two similar sets of chromosomes or genomes (AA), an autotriploid will have three similar genomes (AAA), and an autotetraploid, will have four such genomes

(AAAA). Since an autotriploid remains sterile and cannot produce seeds, therefore, it has great commercial value in producing seedless varieties of economical plants.

For example, in Japan, H. Kihara produced seedless watermelons, which were autotriploids. Common 'doob' grass of U. P. and Bihar is an autotriploid. Other common seedless autopolyploids are grapes, sugarbeet, Banana, etc. In *O. lamarckiana*, the giant mutant described by de Vries was later on discovered to be an autotetraploid. Further, whenever autopolyploids, originate in nature, these would be eliminated due to natural selection.

The chromosome sets or genomes are identical. The genome formula (capital letters represent a group of chromosomes that is generally referred to as the basic genome or chromosome set) is AAA (autotriploidy), or BBBB (autotetraploidy), etc. Autopolyploids are also called polysomicpolyploids.

### **Origin of Autopolyploids**

Autopolyploids spontaneously occur in the nature in a low frequency and can be induced artificially using various ways, such as heat and chemical treatments, decapitation, and selection from twin seedlings. The effective method to obtain autopolyploids is using colchicine. Colchicine is a spindle fiber poison or suppressant. It inhibits the spindle mechanism at mitosis, resulting in multiples of normal chromosome number.

### **Triploids**

Triploids are usually autopolyploids. They arise spontaneously in nature or are constructed by geneticists from the cross of a  $4x$  (tetraploid) and a  $2x$  (diploid). The  $2x$  and the  $x$  gametes unite to form a  $3x$  triploid. Autotriploids are genetically equal to trisomics for each chromosome. The three chromosomes will pair as a trivalent or a bivalent plus a univalent. Chromosome separation from such pairing is irregular. Daughter nuclei will receive either one or two copies from each chromosome. Consequently, most of the gametes resulting from autotriploid individuals do not have balanced chromosome complements and are not viable. If progeny survives from autotriploids it is mostly an aneuploid. Autotriploids can be produced by crossing diploids with their corresponding autotetraploids. The high sterility of autotriploids has been explored in plant breeding. Triploid bananas ( $2n = 33$ ) are vigorous but seedless and therefore preferred for food consumption.

Triploid watermelons have only undeveloped seeds. Triploid is also applied in seedless Citrus cultivars.

Triploids are characteristically sterile. The problem, like that of monploids, lies in pairing at meiosis. Synapsis, or true pairing, can take place only between two chromosomes, but one chromosome can pair with one partner along part of its length and with another along the remainder, which gives rise to an association of three chromosomes. Paired chromosomes of the type found in diploids are called **bivalents**. Associations of three chromosomes are called **trivalents**, and unpaired chromosomes are called **univalents**. Hence in triploids there are two pairing possibilities, resulting either in a trivalent or in a bivalent plus a univalent. Paired centromeres segregate to opposite poles, but unpaired centromeres pass to either pole randomly as below:

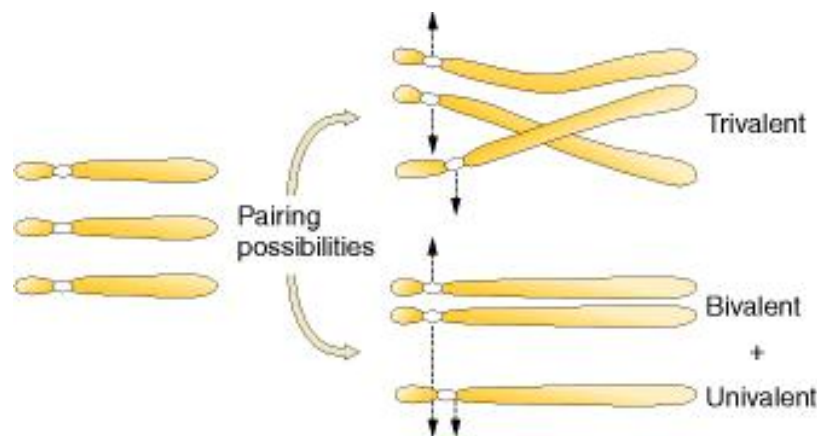

Figure d. Two possibilities for the pairing of three homologous chromosomes before the first meiotic division in a triploid. Notice that the outcome will be the same in both cases: one resulting cell will receive two chromosomes and the other will receive just one. The probability that the latter cell can become a functional haploid gamete is very small, however, because, to do so, it would also have to receive only one of the three homologous chromosomes of every other set in the organism. Note that each chromosome is really a pair of chromatids.

### **Autotetraploids**

Autotetraploids arise naturally by the spontaneous accidental doubling of a 2x genome to a 4x genome, and autotetraploidy can be induced artificially through

the use of colchicine. Autotetraploid plants are advantageous as commercial crops because, in plants, the larger number of chromosome sets often leads to increased size. Cell size, fruit size, flower size, stomata size, and so forth, can be larger in the polyploidy.

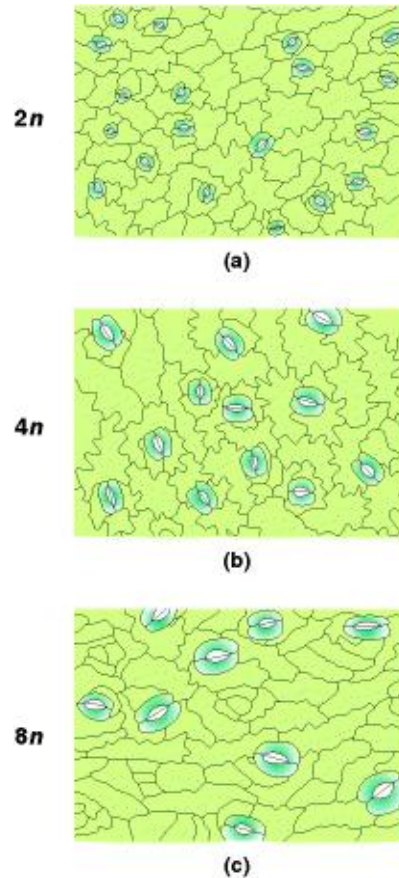

Figure e. Epidermal leaf cells of tobacco plants, showing an increase in cell size, particularly evident in stoma size, with an increase in autopolyploidy. (a) Diploid, (b) tetraploid, (c) octoploid. (From W. Williams, *Genetic Principles and Plant Breeding*. Blackwell Scientific Publications, Ltd.)

Here we see another effect that must be explained by gene numbers. Presumably the amount of gene product (protein or RNA) is proportional to the number of genes in the cell, and this number is higher in the cells of polyploids compared with diploids.



Polyploid plants are often larger and have larger organs than their diploid relatives. Because 4 is an even number, autotetraploids can have a regular meiosis, although this is by no means always the case. The crucial factor is how the four homologous chromosomes, one from each of the four sets, pair and segregate. There are several possibilities, as shown in figure below.

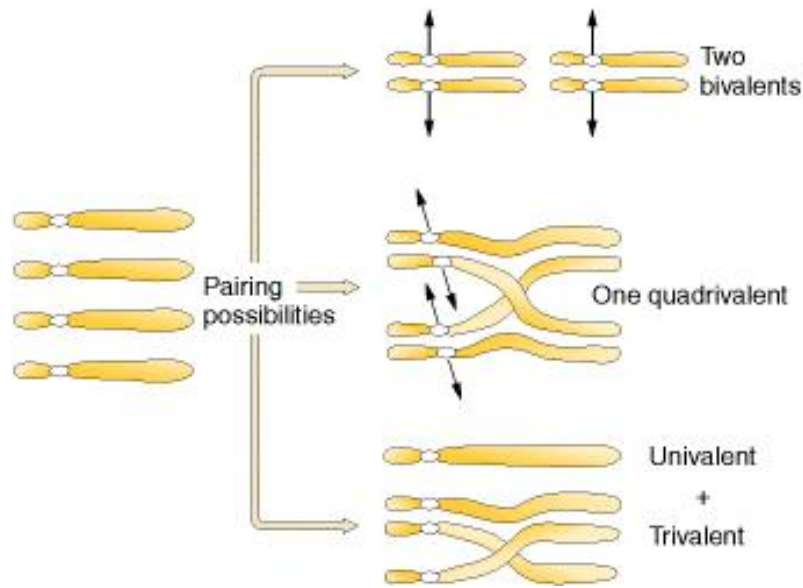

Figure f. Meiotic pairing possibilities in tetraploids. (Each chromosome is really two chromatids.) The four homologous chromosomes may pair as two bivalents or as a quadrivalent. Both possibilities can yield functional gametes. However, the four chromosomes may also pair in a univalent-trivalent combination, yielding nonfunctional gametes. A specific tetraploid can show one or more of these pairings.

### Aneuploidy

Aneuploidy is the second major category of chromosome mutations in which chromosome number is abnormal. An **aneuploid** is an individual organism whose chromosome number differs from the wild type by part of a chromosome set. Generally, the aneuploid chromosome set differs from wild type by only one or a small number of chromosomes. Aneuploids can have a chromosome number either greater or smaller than that of the wild type. Aneuploid nomenclature is based on the number of copies of the specific chromosome in the aneuploid state. For example, the aneuploid condition  $2n-1$  is called **monosomic** (meaning "one

chromosome") because only one copy of some specific chromosome is present instead of the usual two found in its diploid progenitor. The aneuploid  $2n+1$  is called **trisomic**,  $2n-2$  is **nullisomic**, and  $n+1$  is **disomic**.

### **Nullisomics ( $2n-2$ )**

Although nullisomy is a lethal condition in diploids, an organism such as bread wheat, which behaves meiotically like a diploid although it is a hexaploid, can tolerate nullisomy. The four homoeologous chromosomes apparently compensate for a missing pair of homologs. In fact, all the possible 21 bread wheat nullisomics have been produced. Their appearances differ from the normal hexaploids; furthermore, most of the nullisomics grow less vigorously.

The diploid organisms which have lost a pair of homologous chromosomes are called nullosomics with the genomic formula,  $2n-2$ . The nullosomics exhibit reduced vigor, fertility and survivality, but, polyploidic nullosomics such as nullosomic hexaploid wheat ( $6n-2$ ) survive to maturity because of the genetic redundancy in polyploids.

### **Monosomics ( $2n-1$ )**

Monosomic chromosome complements are generally deleterious for two main reasons. First, the missing chromosome perturbs the overall gene balance in the chromosome set. Second, having a chromosome missing allows any deleterious recessive allele on the single chromosome to be hemizygous and thus to be directly expressed phenotypically. Notice that these are the same effects produced by deletions.

Nondisjunction in mitosis or meiosis is the cause of most aneuploids. Disjunction is the normal separation of homologous chromosomes or chromatids to opposite poles at nuclear division. Nondisjunction is a failure of this disjoining process, and two chromosomes (or chromatids) go to one pole and none to the other. Nondisjunction occurs spontaneously; it is another example of a chance failure of a basic cellular process.



Monosomics show the deleterious effects of genome imbalance, as well as unexpected expression of recessive alleles carried on the monosomic chromosome.

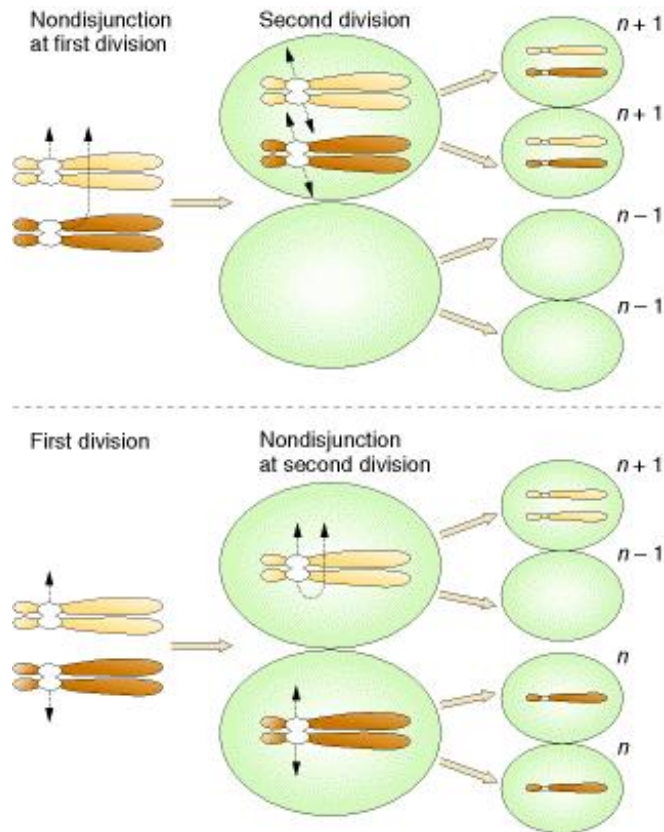

Figure AN 1. The origin of aneuploid gametes by nondisjunction at the first or second meiotic division.

### Trisomics

A diploid cell with an extra chromosome. Basically a diploid with an extra chromosome of one type, producing a chromosome number of the form  $2n + 1$ . The diploid organisms which have one extra chromosome are called trisomies. They have the chromosomal formula  $2n+1$ . In a trisomic, one of the pairs of chromosomes has an extra member, therefore, forms a trivalent structure during meiosis. During anaphase of meiosis, two chromosomes go to one pole and one chromosome to another pole and thus, two types of gametes  $n + 1$  and  $n$  are resulted. The trisomy has variable effects on the phenotype of the organism and in man trisomy of autosome 21 cause mongolism.

In plants, first case of trisomy was investigated in *Datura stramonium* (Jimson weed) by Blakeslee and Belting in 1924. *D. stramonium* normally has 12 pairs of chromosomes in the somatic cells, but in a individual they discovered 25 chromosomes ( $2n + 1$ ). The size, shape and spine characteristic of seed capsule of this trisomic plant had difference with seed capsule of the wild type. species. Theoretically, because the complement was composed of 12 chromosome pairs differing in the genes they carried, 12 distinguishable trisomies were possible in Jimson weed. Through experimental breeding, Blakeslee and his associates succeeded in producing all 12 possible trisomies. These were grown in Blakeslee's garden and each was found to have a distinguishable phenotype that was attributed to an extra set of the genes contained in one of the 12 chromosomes.

### **Tetrasomy**

When one chromosome of an otherwise diploid organism is present in quadruplicate, the tetrasomy is resulted. The tetrasomics have the chromosomal formula  $20+2$ . During meiosis a quadrivalent is formed by extra chromosomes and segregation of chromosomes occurs like autotetraploids.

### **Double Trisomy**

In a diploid organism when two different chromosomes are represented in triplicate, the, double, trisomy is resulted. A double trisomic has the chromosomal formula  $2n+1+1$ .

The following indicates in details the types of chromosome mutation where whole genes are moved:

## STRUCTURAL CHROMOSOMAL ABERRATIONS

**Structural chromosomal aberrations cause** structural abnormalities in chromosome structure. They alter the sequence or the kind of genes present in chromosome. These are further classified into four groups based upon whether they alter the gene sequences, number or location.

### Changes in the structure of chromosomes.

- a. Loss or addition of segments of chromosomes.

**Deletion (deficiency)** - Loss of a segment of a chromosome

**Duplication** - repetition of a segment of a chromosome.

- b. Changes in the normal arrangement of genes in the chromosome.

**Translocation** – Exchange of segments between two non - homologous chromosomes, resulting in new chromosomes.

**Inversion** – Change in the linear order of genes by rotation of a section of a chromosome through 180 degrees.

**Gene mutations or point mutations** – changes in the nucleotide sequence of a gene.

- a. Deletion
- b. Insertion
- c. Substitution
- d. Inversion

### a. Loss or addition of segments of chromosomes

#### Deletion of a Gene

As the name implies, genes of a chromosome are permanently lost as they become unattached to the centromere and are lost forever

Normal chromosome before mutation

- Genes not attached to centromere become loose and lost forever
- New chromosome lacks certain genes which may prove fatal depending on how important these genes are

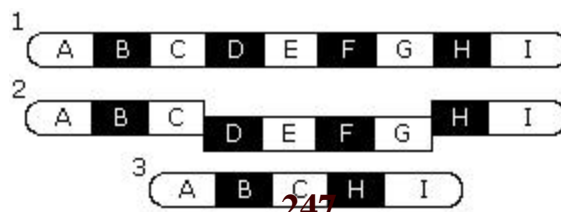

### Duplication of Genes

In this mutation, the mutant's genes are displayed twice on the same chromosome due to duplication of these genes. This can prove to be an advantageous mutation as no genetic information is lost or altered and new genes are gained

Normal chromosome before mutation

- Genes from the homologous chromosome are copied and inserted into the genetic sequence
- New chromosome possesses all its initial genes plus a duplicated one, which is usually harmless

The next page continues looking at these chromosome mutations and mutations that happen within genes that can prove to be more harmful to the organism at hand. The following pages also investigate polyploidy in species.

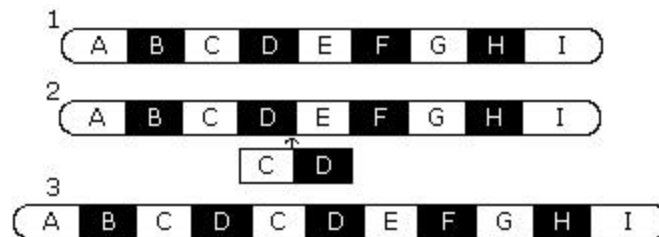

### b. Changes in the normal arrangement of genes in the chromosome

#### Inversion of Genes

This is where the order of a particular order of genes are reversed as seen below

- Normal chromosome un-altered
- The connection between genes break and the sequence of these genes are reversed
- The new sequence may not be viable to produce an organism, depending on which genes are reversed. Advantageous characteristics from this mutation are also possible

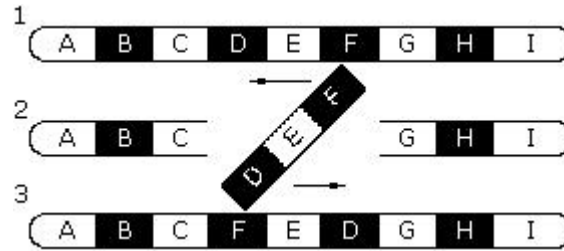

### Translocation of Genes

This is where information from one of two homologous chromosomes breaks and binds to the other. Usually this sort of mutation is lethal

- An un-altered pair of homologous chromosomes
- Translocation of genes has resulted in some genes from one of the chromosomes attaching to the opposing chromosome

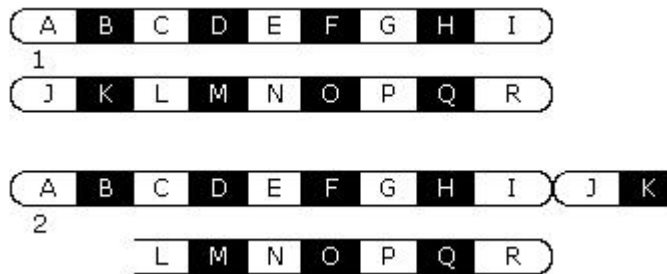

## II. Gene mutations or point mutations

### Alteration of a DNA Sequence

The previous examples of mutation have investigated changes at the chromosome level. The sequence of nucleotides on a DNA sequence are also susceptible to mutation.

#### Substitution

A substitution is a mutation that exchanges one base for another (i.e., a change in a single "chemical letter" such as switching an A to a G). Such a substitution could:

1. change a codon to one that encodes a different amino acid and cause a small change in the protein produced. For example, [sickle cell anemia](#) is caused by

a substitution in the beta-hemoglobin gene, which alters a single amino acid in the protein produced.

2. change a codon to one that encodes the same amino acid and causes no change in the protein produced. These are called silent mutations.

change an amino-acid-coding codon to a single "stop" codon and cause an incomplete protein. This can have serious effects since the incomplete protein probably won't function.

CTGGAG  
CTGGGG

### Insertion

Insertions are mutations in which extra base pairs are inserted into a new place in the DNA.

CTGGAG  
CTGGTGGAG

### Deletion

Deletions are mutations in which a section of DNA is lost, or deleted.

CTGGAG  
CTAG

### **Inversion**

### **Frameshift**

Since protein-coding DNA is divided into codons three bases long, insertions and deletions can alter a gene so that its message is no longer correctly parsed. These changes are called frameshifts.

For example, consider the sentence, "The fat cat sat." Each word represents a codon. If we delete the first letter and parse the sentence in the same way, it doesn't make sense.

In frameshifts, a similar error occurs at the DNA level, causing the codons to be parsed incorrectly. This usually generates truncated proteins that are as useless as "hef atc ats at" is uninformative.

~~T~~he fat cat sat  
hef atc ats at

Genetic mutations increase genetic diversity and therefore have an important part to play. They are also the reason many people inherit diseases.



This Book Download From e-course of ICAR  
**Visit for Other Agriculture books, News,  
Recruitment, Information, and Events at**  
**[WWW.AGRIMOON.COM](http://WWW.AGRIMOON.COM)**

Give FeedBack & Suggestion at [info@agrimoon.com](mailto:info@agrimoon.com)

**DISCLAIMER:**

The information on this website does not warrant or assume any legal liability or responsibility for the accuracy, completeness or usefulness of the courseware contents.

The contents are provided free for noncommercial purpose such as teaching, training, research, extension and self learning.

